

# VW 1600 TRANSPORTER

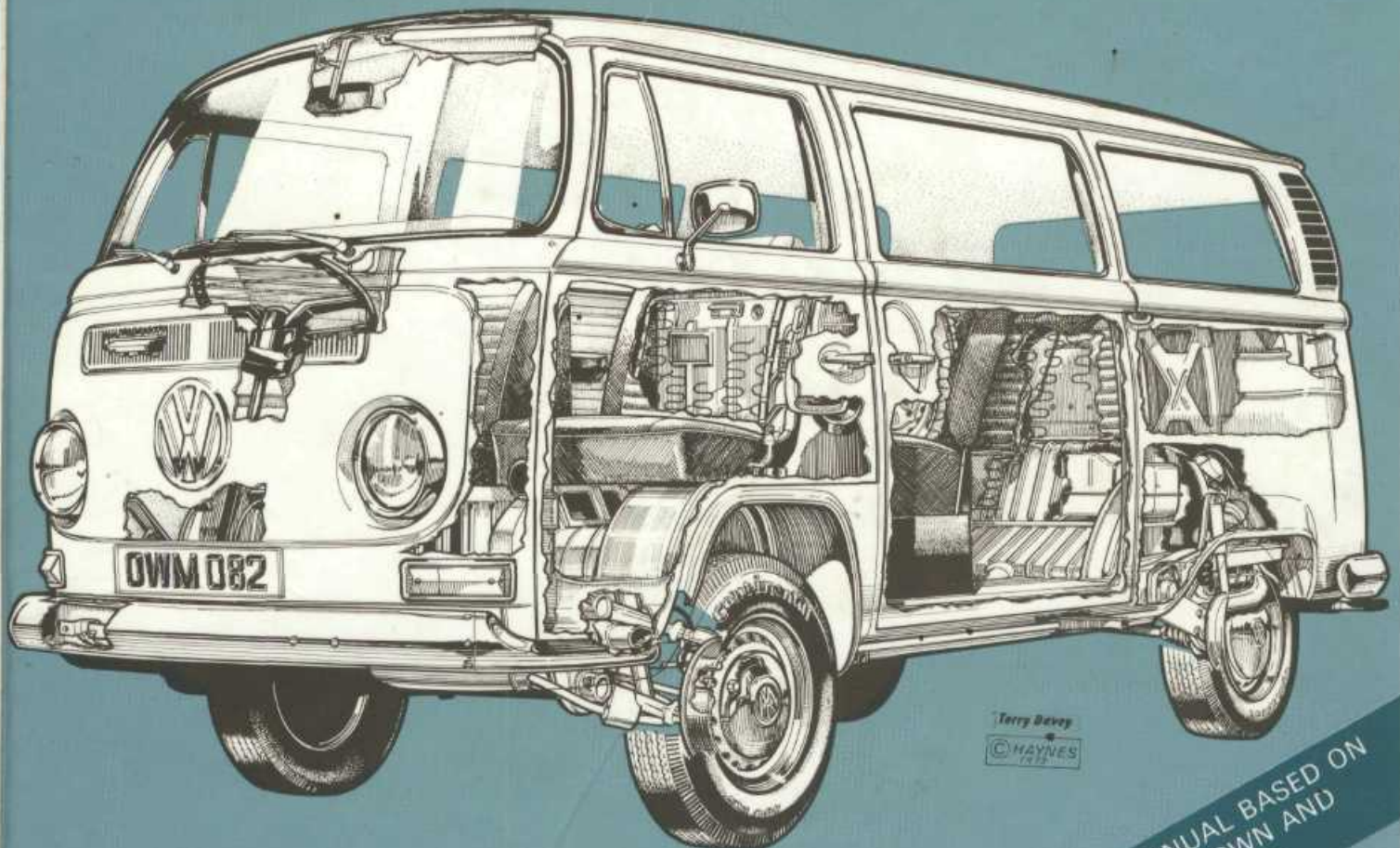
1968 to 1979

All models □ 1584 cc (96.7 cu in)



THE  
BOOK

## Owners Workshop Manual



EVERY MANUAL BASED ON  
A STRIPDOWN AND  
REBUILD

# VW Transporter 1600 Owners Workshop Manual

by J H Haynes

Member of the Guild of Motoring Writers

and DH Stead

**Models covered:**

All Volkswagen Transporter 1600 models with 1584 cc  
(96.7 cu in) engine

*Does not cover the alternative bodies and conversions produced by specialist  
manufacturers*

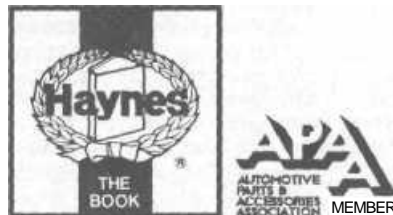
ISBN 0 85696 660 6

© Haynes Publishing Group 1990

All rights reserved. No part of this book may be reproduced or transmitted in  
any form or by any means, electronic or mechanical, including photocopying,  
recording or by any information storage or retrieval system, without permission  
in writing from the copyright holder.

Printed in the USA (082 - 2S6)

ABCDE  
FGHI  
JKLM



**Haynes Publishing Group**  
Sparkford Nr Yeovil  
Somerset BA22 7JJ England

**Haynes Publications, Inc**  
861 Lawrence Drive  
Newbury Park  
California 91320 USA

# Acknowledgements

Thanks are due to the VW organisation for the supply of technical information and certain illustrations. Castrol Limited provided lubrication details and the Champion Sparking Plug Company supplied the illustrations showing the various spark

plug conditions.

Lastly, thanks are due to all those people at Sparkford who helped in the production of this manual.

# About this manual

## *Its aim*

The aim of this manual is to help you get the best value from your vehicle. It can do so in several ways. It can help you decide what work must be done (even should you choose to get it done by a garage), provide information on routine maintenance and servicing, and give a logical course of action and diagnosis when random faults occur. However, it is hoped that you will use the manual by tackling the work yourself. On simpler jobs it may even be quicker than booking the car into a garage and going there twice, to leave and collect it. Perhaps most important, a lot of money can be saved by avoiding the costs a garage must charge to cover its labour and overheads.

The manual has drawings and descriptions to show the function of the various components so that their layout can be understood. Then the tasks are described and photographed in a step-by-step sequence so that even a novice can do the work.

## *Its arrangement*

The manual is divided into twelve Chapters, each covering a logical sub-division of the vehicle. The Chapters are each divided into Sections, numbered with single figures, eg 5; and the Sections into paragraphs (or sub-sections), with decimal numbers following on from the Section they are in, eg 5.1, 5.2, 5.3 etc.

# Introduction

The Volkswagen Type 2, more generally referred to as the bus, pick-up, Kombi, transporter, caravette, van or any other name that indicates that it is not an ordinary saloon, was conceived very soon after VW Beetle production was seriously under way in 1949.

Heinz Nordhoff realised that in the reconstruction of Germany after the war the demand for a cheap workhorse vehicle would be almost as great as that for saloons. The beauty of it all was that due to the basic Beetle design he could use the same components. All he had to do was gear down the drive train to cope with increased engine loads; and this was achieved by the expedient of fitting simple spur reduction gears at the outer ends of the drive shafts. It was then possible to use the same gearbox/final drive unit with the crownwheel the other way round so that the drive shafts would rotate the other way into the reduction gears.

The rest of the story is a legend comparable to that of the Beetle. The basic ideas were developed and improved as the years went by and it was not until 1967 that the development became significantly different.

In that model year the vehicle suddenly appeared larger and

It is freely illustrated, especially in those parts where there is a detailed sequence of operations to be carried out. There are two forms of illustration: figures and photographs. The figures are numbered in sequence with decimal numbers, according to their position in the Chapter - eg Fig. 6.4 is the fourth drawing/illustration in Chapter 6. Photographs carry the same number (either individually or in related groups) as the Section or sub-section to which they relate.

There is an alphabetical index at the back of the manual as well as a contents list at the front. Each Chapter is also preceded by its own individual contents list.

References to the 'left' or 'right' of the vehicle are in the sense of a person in the driver's seat facing forwards.

Unless otherwise stated, nuts and bolts are removed by turning anti-clockwise, and tightened by turning clockwise.

Vehicle manufacturers continually make changes to specifications and recommendations, and these, when notified, are incorporated into our manuals at the earliest opportunity.

**Whilst every care is taken to ensure that the information in this manual is correct, no liability can be accepted by the authors or publishers for loss, damage or injury caused by any errors in, or omissions from, the information given.**

noticeably different from its predecessors. The 1600 cc engine became standard, the rear suspension changed from swing axle to diagonal arm and, most noticeable of all, the familiar split windscreen changed to a larger one, curved, and in a single piece.

It is perhaps significant that the 'mobile home' version, with beds, cookers and all the other necessities for living on the move has achieved such a significant (and expensive!) proportion of the overall model type. Traditionally commercial vehicle users are interested solely in the economic attractions of their transport and do not generally fall into the category of 'Do-it-yourself' motorists. Consequently the strictly commercial models disappear from the scene when their worth in financial terms is no longer economic. The models that survive from the past in the hands of private owners tend therefore, to consist of the multi-seat or conversion for a holiday home types.

This manual gives practical insight into the workings of a transporter and will enable owners who are not familiar with the somewhat unconventional layout to understand it better.

The servicing and repair procedures explained in the manual are those which have been actually carried out by the team of writer, mechanic and photographer working together.

# Contents

	Page
Acknowledgements	2
About this manual	2
Introduction	2
Tools and working facilities	5
Recommended lubricants and fluids	7
Vehicle identification and spare parts	8
Routine maintenance <i>(also see Chapter 12, page 194)</i>	9
Chapter 1 Engine <i>(also see Chapter 12, page 194)</i>	12
Chapter 2 Cooling, heating and exhaust systems <i>(also see Chapter 12, page 194)</i>	42
Chapter 3 Fuel system and carburation <i>(also see Chapter 12, page 194)</i>	57
Chapter 4 Ignition system <i>(also see Chapter 12, page 194)</i>	74
Chapter 5 Clutch and operating mechanism	83
Chapter 6 Transmission and final drive <i>(also see Chapter 12, page 194)</i>	91
Chapter 7 Wheel shafts, drive shafts and universal joints	111
Chapter 8 Braking system <i>(also see Chapter 12, page 194)</i>	118
Chapter 9 Electrical system <i>(also see Chapter 12, page 194)</i>	138
Chapter 10 Suspension, dampers and steering <i>(also see Chapter 12, page 194)</i>	165
Chapter 11 Bodywork and underframe <i>(also see Chapter 12, page 194)</i>	182
<b>Chapter 12 Supplement: Revisions and information on later models</b>	<b>194</b>
Conversion factors	220
Safety first! * ,	221
Index	222



# Tools and working facilities

## Introduction

A selection of good tools is a fundamental requirement for anyone contemplating the maintenance and repair of a motor vehicle. For the owner who does not possess any, their purchase will prove a considerable expense, offsetting some of the savings made by doing-it-yourself. However, provided that the tools purchased meet the relevant national safety standards and are of good quality, they will last for many years and prove an extremely worthwhile investment.

To help the average owner to decide which tools are needed to carry out the various tasks detailed in this manual, we have compiled three lists of tools under the following headings: *Maintenance and minor repair*, *Repair and overhaul*, and *Special*. The newcomer to practical mechanics should start off with the *Maintenance and minor repair* tool kit and confine himself to the simpler jobs around the vehicle. Then, as his confidence and experience grow, he can undertake more difficult tasks, buying extra tools as, and when, they are needed. In this way, a *Maintenance and minor repair* tool kit can be built-up into a *Repair and overhaul* tool kit over a considerable period of time without any major cash outlays. The experienced do-it-yourselfer will have a tool kit good enough for most repair and overhaul procedures and will add tools from the *Special* category when he feels the expense is justified by the amount of use these tools will be put to.

It is obviously not possible to cover the subject of tools fully here. For those who wish to learn more about tools and their use there is a book entitled *How to Choose and Use Car Tools* available from the publishers of this manual.

## Maintenance and minor repair tool kit

The tools given in this list should be considered as a minimum requirement if routine maintenance, servicing and minor repair operations are to be undertaken. We recommend the purchase of combination spanners (ring one end, open-ended the other); although more expensive than open-ended ones, they do give the advantages of both types of spanner.

- Combination spanners - 10, 11, 12, 13, 14 & 17 mm
- Adjustable spanner - 9 inch
- Spark plug spanner (with rubber insert)
- Spark plug gap adjustment tool
- Set of feeler gauges
- Brake bleed nipple spanner
- Screwdriver - 4 in long x  $\frac{1}{4}$  in dia (flat blade)
- Screwdriver - 4 in long x  $\frac{1}{8}$  in dia (cross blade)
- Combination pliers - 6 inch
- Hacksaw (junior)
- Tyre pump
- Tyre pressure gauge
- Grease gun
- Oil can
- Fine emery cloth (1 sheet)
- Wire brush (small)
- Funnel (medium size)

## Repair and overhaul tool kit

These tools are virtually essential for anyone undertaking any major repairs to a motor vehicle, and are additional to those given in the *Maintenance and minor repair* list. Included in this list is a comprehensive set of sockets. Although these are expensive they will be found invaluable as they are so versatile - particularly if various drives are included in the set. We recommend the  $\frac{1}{2}$  in square-drive type, as this can be used with most proprietary torque spanners. If you cannot afford a socket set, even bought piecemeal, then inexpensive tubular box wrenches are a useful alternative.

The tools in this list will occasionally need to be supplemented by tools from the *Special* list.

- Sockets (or box spanners) to cover range in previous list
- Reversible ratchet drive (for use with sockets)
- Extension piece, 10 inch (for use with sockets)
- Universal joint (for use with sockets)
- Torque wrench (for use with sockets)
- Mole wrench - 8 inch
- Ball pein hammer
- Soft-faced hammer, plastic or rubber
- Screwdriver - 6 in long x  $\frac{1}{4}$  in dia (flat blade)
- Screwdriver - 2 in long x  $\frac{1}{4}$  in square (flat blade)
- Screwdriver - 1\ in long x  $\frac{1}{8}$  in dia (cross blade)
- Screwdriver - 3 in long x  $\frac{1}{8}$  in dia (electricians)
- Pliers - electricians side cutters
- Pliers - needle nosed
- Pliers - circlip (internal and external)
- Cold chisel -  $\frac{1}{2}$  inch
- Scriber
- Scraper
- Centre punch
- Pin punch
- Hacksaw
- Valve grinding tool
- Steel rule/straight-edge
- Allen keys
- Selection of files
- Wire brush (large)
- Axle-stands
- Jack (strong scissor or hydraulic type)

## Special tools

The tools in this list are those which are not used regularly, are expensive to buy, or which need to be used in accordance with their manufacturers' instructions. Unless relatively difficult mechanical jobs are undertaken frequently, it will not be economic to buy many of these tools. Where this is the case, you could consider clubbing together with friends (or joining a motorists' club) to make a joint purchase, or borrowing the tools against a deposit from a local garage or tool hire specialist.

produced by the vehicle manufacturer specifically for its dealer network. You will find occasional references to these manufacturers' special tools in the text of this manual. Generally, an alternative method of doing the job without the vehicle manufacturers' special tool is given. However, sometimes, there is no alternative to using them. Where this is the case and the relevant tool cannot be bought or borrowed you will have to entrust the work to a franchised garage.

Valve spring compressor  
 Piston ring compressor  
 Balljoint separator  
 Universal hub/bearing puller  
 Impact screwdriver  
 Micrometer and/or vernier gauge  
 Dial gauge  
 Stroboscop/c timing light  
 Dwell angle meter/tachometer  
 Universal electrical multi-meter  
 Cylinder compression gauge  
 Lifting tackle  
 Trolley jack  
 Light with extension lead

### Buying tools

For practically all tools, a tool factor is the best source since he will have a very comprehensive range compared with the average garage or accessory shop. Having said that, accessory shops often offer excellent quality tools at discount prices, so it pays to shop around.

There are plenty of good tools around at reasonable prices, but always aim to purchase items which meet the relevant national safety standards. If in doubt, ask the proprietor or manager of the shop for advice before making a purchase.

### Care and maintenance of tools

Having purchased a reasonable tool kit, it is necessary to keep the tools in a clean serviceable condition. After use, always wipe off any dirt, grease and metal particles using a clean, dry cloth, before putting the tools away. Never leave them lying around after they have been used. A simple tool rack on the garage or workshop wall, for items such as screwdrivers and pliers is a good idea. Store all normal spanners and sockets in a metal box. Any measuring instruments, gauges, meters, etc, must be carefully stored where they cannot be damaged or become rusty.

Take a little care when tools are used. Hammer heads inevitably become marked and screwdrivers lose the keen edge on their blades from time to time. A little timely attention with emery cloth or a file will soon restore items like this to a good serviceable finish.

### Working facilities

Not to be forgotten when discussing tools, is the workshop itself. If anything more than routine maintenance is to be carried out, some form of suitable working area becomes essential.

It is appreciated that many an owner mechanic is forced by circumstances to remove an engine or similar item, without the benefit of a garage or workshop. Having done this, any repairs should always be done under the cover of a roof.

Wherever possible, any dismantling should be done on a clean flat workbench or table at a suitable working height.

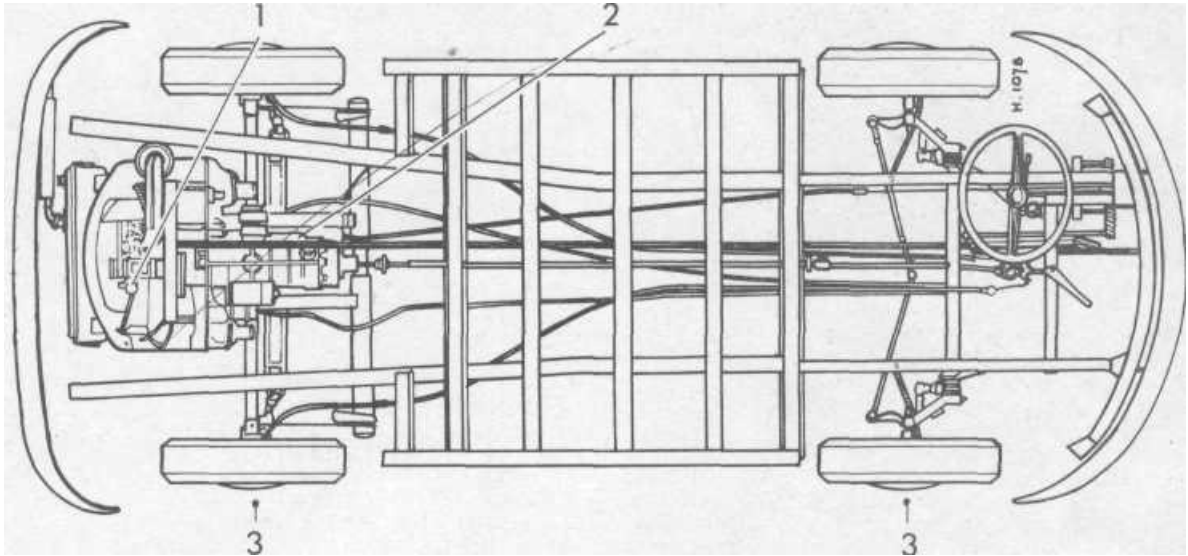
Any workbench needs a vice: one with a jaw opening of 4 in (100 mm) is suitable for most jobs. As mentioned previously, some clean dry storage space is also required for tools, as well as the lubricants, cleaning fluids, touch-up paints and so on which become necessary.

Another item which may be required, and which has a much more general usage, is an electric drill with a chuck capacity of at least 1/2 in (8 mm). This, together with a good range of twist drills, is virtually essential for fitting accessories such as wing mirrors and reversing lights.

and clean, lint-free rags available, and try to keep any working area as clean as possible.

### Spanner jaw gap comparison table

Jaw gap (in)	Spanner size
0.250	1/4 in AF
0.276	7 mm
0.313	5/16 in AF
0.315	8 mm
0.344	11/32 in AF; 1 8 in Whitworth
0.354	9 mm
0.375	3/8 in AF
0.394	10 mm
0.433	1 T mm
0.438	7/16 in AF
0.445	3/16 in Whitworth; 1/4 in BSF
0.472	12 mm
0.500	1/2 in AF
0.512	13 mm
0.525	1/4 in Whitworth; 5/16 in BSF
0.551	14 mm
0.563	9/16 in AF
0.591	15 mm
0.600	5/16 in Whitworth; 3/8 in BSF
0.625	5/8 in AF
0.630	16 mm
0.669	17 mm
0.686	11/16 in AF
0.709	18 mm
0.710	3/8 in Whitworth; 7/16 in BSF
0.748	19 mm
0.750	3/4 in AF
0.813	13/16 in AF
0.820	7/16 in Whitworth; 1/2 in BSF
0.866	22 mm
0.875	7/8 in AF
0.920	1/2 in Whitworth; 9/16 in BSF
0.938	15/16 in AF
0.945	24 mm
1.000	1 in AF
1.010	9/16 in Whitworth; 5/8 in BSF
1.024	26 mm
1.063	1 1/16 in AF; 27 mm
1.100	5/8 in Whitworth; 11/16 in BSF
1.125	1 1/8 in AF
1.181	30 mm
1.200	11/16 in Whitworth; 3/4 in BSF
1.250	1 1/4 in AF
1.260	32 mm
1.300	3/4 in Whitworth; 7/8 in BSF
1.313	1 5/16 in AF
1.390	1 3/16 in Whitworth; 1 5/16 in BSF
1.417	36 mm
1.438	1 7/16 in AF
1.480	7/8 in Whitworth; 1 in BSF
1.500	T/2 in AF
1.575	40 mm; 1 5/16 in Whitworth
1.614	41 mm
1.625	1 5/8 in AF
1.670	1 in Whitworth; 1 1/8 in BSF
1.688	1 11/16 in AF
1.811	46 mm
1.813	1 13/16 in AF
1.860	1 1/8 in Whitworth; 1 1/2 in BSF
1.875	1 7/8 in AF
1.969	50 mm
2.000	2 in AF
2.050	1 1/4 in Whitworth; 1 3/8 in BSF
2.165	55 mm
2.362	60 mm



## Recommended lubricants and fluids

Component or system	Lubricant type or specification	Castrol product
Engine (1)	SAE 30 or 40 or SAE 20W/50	Castrol CR1 30 or 40 or Castrol GTX
Transmission (2)	SAE 90 Hypoid	Castrol <b>Hypoy 90</b>
Transmission with limited slip differential (2)	SAE 90 Hypoid LS	Castrol 90 LS
Wheel bearings (3)	NGL1 No 2	Castrol LM Grease
Brake hydraulic fluid	SAE J1703	Castrol Girling Universal Brake and Clutch Fluid
Drive shaft CV joints	Lithium grease with molybdenum disulphide	Castrol MS3 Grease

**Note:** The above are general recommendations only. Lubrication requirements may vary with operating conditions and from territory to territory. If in doubt consult the operator's handbook or your VW dealer.

## Vehicle identification and spare parts

Although many individual parts, and in some cases, sub assemblies such as distributors, fit a variety of VW models it is dangerous to assume that just because they look the same that they are the same. Differences are sometimes not visually detectable at all (except by serial numbers).

Components are being modified and developed all the time and do not necessarily coincide with publicly announced model changes. Make sure therefore, that both the chassis number and the engine number are known when a part is ordered. The chassis number is to be found on a plate fitted to the panel alongside the drivers seat (photo). The first two numbers of the chassis number denote the basic type. For example '21' is the van, '22' and '24' the Microbus in standard or de luxe versions, '23' the Kombi, '26' the pick-up range and '27' is an ambulance. The third figure denotes the model year. '8' for example is model year 1968 which runs from August 1967 to July 1968. The remaining digits are the serial numbers for the model year changes.

The engine number is stamped on the engine crankcase below the pedestal which supports the generator. It has one or two prefix letters followed by a serial number. Prefix letters change when there is a significant difference between engines. All engines covered by this manual are the '1600' (1584 6c) version. Engine prefix letters for this series are:—

- 'AS' August 1974 on - compression ratio 7.5 : 1
- 'B' - 47 bhp - early versions with or without exhaust emission control systems
- 'AD' - 50 bhp - 1971 model year
- 'AE' the same as AD but with exhaust emission control
- 'AF' - low compression (6.6 : 1).

As far as the UK is concerned the main source of spares is the VW dealer network. If they cannot supply you with what you want immediately then it is most probably due to the fact that they do not reckon on keeping large stocks for over the counter sales, and although they may have one or two of what you need, cannot afford to risk being out of stock for a customer who brings his car in for repair. VW agents are very helpful but one

cannot blame them for this insistence on keeping a minimum stock level for their own use. It applies particularly to the less common items. So before tearing your vehicle to pieces check the spares position at your VW agency; you could save yourself a lot of trouble.

With gasket sets - for both engine and gearbox - do not be alarmed if there seem to be many items included in the set you buy, which do not fit your vehicle. To save a lot of variety of kits they include in one enough to cover a variety of types over a period of time so you are certain to have some left over. However, it is a good idea to check the set before leaving the parts store. Some of the ones you may need could be omitted. Oil seals particularly are not all included - and this applies to some of the smaller ones. (Oil cooler).



# Routine maintenance

*For modifications, see Supplement at end of manual*

## Introduction

Because of the inherent toughness and reputation for reliability and long life there is a tendency for owners to be a bit sketchy on VW maintenance - particularly with vehicles not in the first flush of youth.

The VW will put up with neglect for a long time but when the crunch eventually does come it is likely to be drastic.

Regular maintenance therefore, is just as important as on any other vehicle.

The service procedures listed hereafter cover all the points of required regular service. The frequency of service tends to vary according to changes in design of various components, the conditions under which the vehicle is used, and the way in which it is driven. The frequencies given are based on a mileage of 12000 per year in a temperate climate which is mainly non dusty.

Variations from this will be taken into account by VW service agencies in different conditions. Variations in driving style must be the responsibility of the driver where servicing requirements could be affected.

Where maintenance is solely a matter of inspection (rather than lubrication, cleaning or adjustment) the findings from such inspections will determine whether or not further action is required. Such further action is no longer within the scope of Routine maintenance. It is a workshop procedure requiring repair or renewal. How to do the maintenance is detailed after the schedules. If the details are already in the main chapters then reference is made appropriately.

A revised Maintenance Schedule based on a 'mileage covered' frequency is included in Chapter 12 Supplement.

## 1 SAFETY MAINTENANCE

- a) Steering tie rod ball joints - Check for wear 3 months
- Steering gear - Check worm to roller play and worm shaft bearings. Adjust if necessary 3 months
- Front wheel bearings - Check end play and adjust if necessary 3 months

- b) Brakes
  - Hydraulic fluid reservoir level 1 month
  - Efficiency and foot pedal free play - Check and adjust as required 3 months
  - Handbrake efficiency - Check and adjust as required
  - Brake friction lining material - Check thickness 6 months
  - Hydraulic lines, hoses, master cylinder wheel cylinders and calipers. Examine exteriors for leaks or corrosion 6 months
  - Renew all seals and fluid 3 years

NOTE: A significant drop in fluid reservoir level or any other indication of fluid leakage is a danger signal. A complete and thorough examination of the hydraulic system should be made.

- c) Suspension
  - Tyres - Inflation pressure check Weekly
  - Tyres - Wear and damage check As suspect
  - Front torsion arm ball joints - Check for wear 3 months
  - Dampers - Check for leakage and malfunction 3 months
- d) Vision
  - Lights functioning (including direction and stop lights)
  - Screen washer operative

## SAFETY MAINTENANCE PROCEDURES

### Steering

See Chapter 10

### Brakes

Hydraulic fluid reservoir level - The reservoir is mounted on the vertical panel in the front of the cab  
Top up to the indicated level with approved fluid as required.  
Remaining items - See Chapter 8.

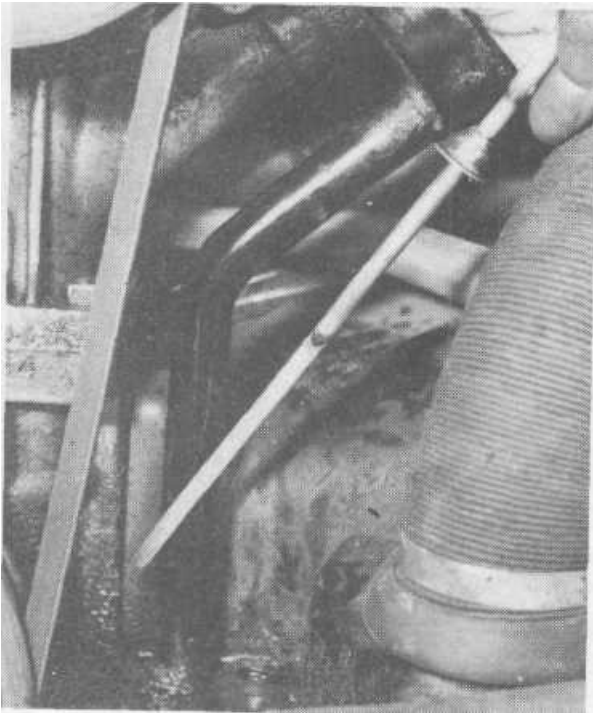
- c) Suspension
  - See Chapter 10.

- d) Vision
  - Lights - See Chapter 9.
  - Screen washer reservoir - The washer liquid reservoir is fitted





The windscreen washer reservoir is mounted on the vertical panel in the front of the cab just below the brake fluid reservoir.



Engine oil dipstick.

to the front panel of the cab just below the hydraulic fluid reservoir. It has a protective cover and tucked inside is a tube with an ordinary tyre valve for pressurisation purposes (photo).

The screen washer reservoir should be full of clean water - with an additive of anti-smear compounds as wished. The tank should be pressurised from an ordinary tyre inflator to the maximum pressure of 42 psi/3 kg cm<sup>2</sup> which is marked on the tank.

If the jets do not direct water on to the screen as they should, refer to Chapter 9 for details.

In the UK correctly functioning screen washers are a legally required fitment to all cars.

### 3 EFFICIENCY AND PERFORMANCE MAINTENANCE

#### a) Engine

Lubricating oil - Top up to level	Weekly
Lubricating oil - Drain, clean filter screen and refill with	
Lubricating oil - fresh oil.	3 months
Fan belt - Check tension and adjust if required.	1 month
Air cleaner - Clean out bowl and refill with oil (oil bath type).	3 months
Air cleaner - Renew paper element (paper element type)	6 months
Air cleaner - Check correct operation of warm air control flaps.	1 month
Battery - Check electrolyte level.	Weekly
Distributor - Check contact points gap. Adjust	
Distributor - and/or renew.	3 months
Distributor - Lubricate cam.	3 months
Valve clearances - Check and adjust as required	
Valve clearances - (renew rocker cover gaskets).	6 months
Spark plugs - Removal clean and reset.	6 months
Spark plugs - Renew.	12 months
Fuel pump-Clean filter.	6 months
Carburettor - Check setting of throttle cable	
Carburettor - and lubricate linkage.	6 months
Cover plates and fan housing - Check security of all screws and grommets.	3 months
b) Suspension	
Front wheel bearings - Repack with grease.	2 years
Rear wheel bearings - Repack with grease.	2 years
c) Transmission and final drive	
Gearbox oil - Check level and top up as needed.	3 months
Gearbox oil - Drain and refill with fresh oil except type 091 manual gearbox (August 1975 on) which is 'filled for life'	
	2 years
Clutch pedal free play - Check movement and adjust.	
	As necessary
Axle shaft flexible gaiters - Check for splits	3 months
Renew charcoal filter (Fuel Evaporative System)	30 000 miles

### 4 EFFICIENCY AND PERFORMANCE MAINTENANCE PROCEDURES

#### a) Engine

Lubricating oil.

To top up the oil, remove the filler cap from the filler pipe at the right hand side of the engine. Remove the dipstick to prevent possible blow back up the filler pipe when pouring oil in. A suitable container or funnel is needed in order to add oil without spillage. The top dipstick mark is the correct capacity level. The lower mark is half full. Do not overfill or let the level drop significantly below the full mark.

When changing the engine oil the filter screen - which is simply wire gauze should be flushed out with paraffin to clear the gauze. This entails removing the circular retaining plate

in the centre of the bottom of the crankcase. Before starting, you must obtain two new gaskets for it, and it is also desirable to get six new copper washers for the stud nuts.

First drain the oil by removing the centre plug and then remove the cover plate. Take care when removing the strainer. Do not distort it.

Later engines do not have the central plug so a suitably large container will be needed to catch the oil as it leaks out when the plate nuts are loosened.

The oil suction pipe which goes into the centre of the strainer gauze must be quite firm. If it is loose then it is likely that suction is being lost and the oil circulation is not 100% efficient. (The engine needs completely stripping to put this right).

The strainer incorporates a relief valve in case the filter mesh should get completely blocked up.

Having thoroughly cleaned everything refit the strainer with a gasket on each side of the flange. See that the suction pipe is properly located in the strainer. Fit new copper washers followed by the cap nuts. Do not overtighten the cap nuts - otherwise the threads may strip.

Replace the drain plug and refill with 4V<sub>2</sub> pints of approved engine oil.

- Fan belt - See Chapter 2.
- Air cleaner - See Chapter 3.
- Battery - See Chapter 9.
- Distributor - See Chapter 4.
- Valve clearances - See Chapter 1.
- Spark plugs - See Chapter 4.
- Fuel pump - See Chapter 3.
- Carburettor - See Chapter 3.

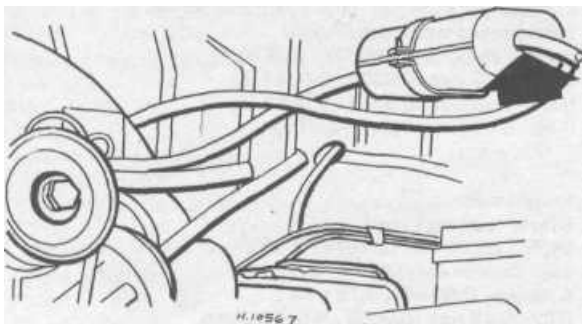
- b) Suspension
  - Front wheel bearings - See Chapter 10.
  - Rear wheel bearings - See Chapter 7.
- c) Transmission and final drive

Gearbox oil - To check the level stand the vehicle on level ground and undo the level plug which is halfway up the side of the casing on the left - just ahead of the axle shafts. This plug is a recessed hexagon which could be very difficult to undo.

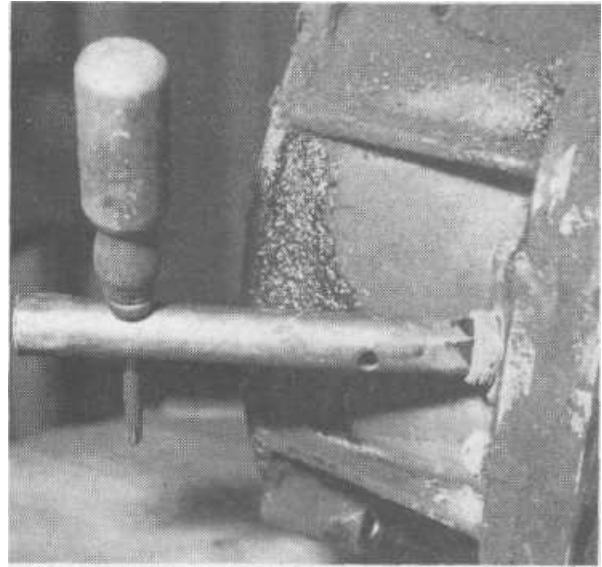
Use a tubular spanner or bolt head which fits snugly. If the plug is burred by makeshift methods it will get progressively more difficult to adjust. Add oil from a suitable oil gun or squeeze pack with flexible filler spout. Add oil slowly until it runs out from the filler/level hole. Clean the plug and replace it tightly.

When changing the transmission oil it is best to run it warm first. Then undo the magnetic drain plug which is in the centre of the casing at an angle at the rear. Let the oil drain out for at least 15 minutes. Clean the magnetic drain plug and replace it. Before beginning to refill get the exact amount of oil needed ready, and then start to fill up through the filler/level plug. It is possible that oil will overflow before you have put it all in. Wait so that the air pockets have time to bubble out and then continue until all the oil is put in.

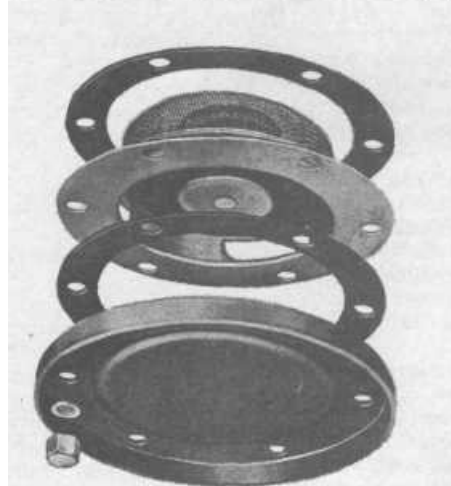
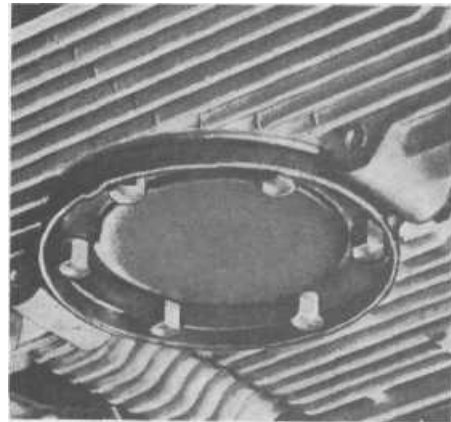
- Clutch pedal free play - See Chapter 5.
- Axle shaft gaiters - See Chapter 7.



**TYPICAL CHARCOAL CANISTER (FUEL EVAPORATIVE SYSTEM) AIR CLEANER REMOVED FOR ACCESS**



**Transmission magnetic oil level plug.**



**ENGINE OIL DRAIN PLATE AND FILTER GAUZE**

# Chapter 1 Engine

For extra information, see Supplement at end of manual

## Contents

General description and type identification ... ..	1	Crankcase - examination and renovation ... ..	20
Repair and maintenance procedures - dismantling ... ..	2	Engine reassembly - general ... ..	21
Engine removal - preparation ... ..	3	Crankshaft - assembly of gears and main bearings ... ..	22
Engine - removal ... ..	4	Connecting rods - assembly to crankshaft ... ..	23
Engine dismantling - general ... ..	5	Crankcase, crankshaft, camshaft and cam followers - re-assembly ... ..	24
Engine ancillaries - removal ... ..	6	Pistons, rings and connecting rods - reassembly ... ..	25
Oil cooler - removal and renovation ... ..	7	Cylinders - replacement ... ..	26
Oil pressure relief and control valves- removal and renovation ... ..	8	Cylinder heads, valves and springs - reassembly ... ..	27
Crankshaft pulley wheel - removal and replacement ... ..	9	Cylinder heads - replacement ... ..	28
Oil pump-removal and replacement ... ..	10	Rocker gear and pushrods - replacement ... ..	29
Cylinder heads - removal ... ..	11	Crankshaft oil seal - replacement ... ..	30
Cylinder heads - dismantling and renovation of rocker gear, valves and springs ... ..	12	Flywheel - replacement ... ..	31
Cylinders, pistons and rings - removal and renovation ... ..	13	Oil pump - replacement ... ..	32
Connecting rods and bearings - removal and renovation ... ..	14	Oil cooler - replacement ... ..	33
Camshaft and tappets - removal and renovation ... ..	15	Valve to rocker clearances-adjustment ... ..	34
Flywheel - removal and renovation ... ..	16	Engine - reassembly of ancillaries ... ..	35
Crankshaft oil seal - removal ... ..	17	Engine - replacement and starting up ... ..	36
Crankshaft and main bearings - removal and renovation ... ..	18	Fault finding ... ..	37
Distributor drive shaft - removal ... ..	19		

## Specifications

Type . . . . .	4 cylinder, horizontally opposed flat, pushrod ohv
Weight . . . . .	240 lbs/ 109 kgs approx.
Bore ...	85.5 mm
Stroke ... ..	69 mm
Capacity	1584 cc
Compression ratio: To April '68 ...	7.7:1
From April '68	7.5:1
Power output (to August '70)	47 DIN bhp at 4000 rpm
(from August '70) ...	50 DIN bhp at 4000 rpm
Torque (to August '70)	82 lb ft at 3000 rpm
(from August '70). . . . .	81.7 lb ft at 3000 rpm
Compression pressure	114 - 142 psi (8.0- 10.0 kg cm <sup>2</sup> )
Location of No 1 cylinder ...	Right hand front (nearest front of vehicle)
Firing order ...	1 (R. Front) 4 (L. Rear) 3 (L. Front) 2 (R. Rear)
Engine mounting ... ..	By cross member carrier and gearbox mountings.

## Camshaft and camshaft bearings

Camshaft drive	Lightweight alloy gear direct from crankshaft
Camshaft bearings	Steel backed white metal shells
Camshaft journal diameters	24.99 - 25.00 mm (0.9837 - 0.9842 in)
Journal/bearing radial clearance	0.02 - 0.12 mm (0.0008 - 0.0047 in)
End float . . . . .	0.04 - 0.16 mm (0.0016 - 0.0063 in)
Gear backlash	0.00 - 0.05 mm (0.00 - 0.002 in)

## Connecting rods and bearings

Type . . . . .	Forged steel
Big end bearings	3 layer thin-wall shells
Crankpin (big end) diameter	54.98 - 55.00 mm (2.1644 - 2.1653 in)
Small end bush	Lead/bronze coated steel - pressed in.
Undersize big end shells available ...	0.25 mm, 0.50 mm, 0.75 mm.
Crankpin to bearing clearance limits	0.02 - 0.15 mm (0.0008 - 0.006 in)
Crankpin end float ...	0.1 - 0.7 mm (0.004 - 0.028 in)
Gudgeon pin/bush radial clearance limits	0.01 - 0.04 mm (0.0004 - 0.0016 in)
Gudgeon pin diameter	21.996 - 22 mm (0.8658 - 0.8661 in)

Connecting rod weight - brown or white	...	...	...	580 - 588 grams
grey or black	...	...	...	592 - 600 grams
Maximum crankpin ovality	...	...	...	0.03 mm (0.0011 in)
<b>Crankshaft and main bearings</b>				
Number of bearings	...	...	...	4
Main bearing journal diameters Nos 1, 2 and 3	...	...	...	54.97 - 54.99 mm (2.164 - 2.1648 in)
No 4	...	...	...	39.98 - 40.00 mm (1.5739 - 1.5748 in)
Regrind diameters undersize	...	...	...	.25 mm, .50 mm, .75 mm
Bearing shells - type Nos 1, 3 and 4	...	...	...	Aluminium, lead coated 1 piece
Bearing shells - type No 2	...	...	...	Split - 3 layer steel backed
<b>Journal/bearing radial clearance limit</b>				
Nos 1 and 3	...	...	...	0.04 - 0.18 mm (0.0016 - 0.007 in)
No 2	...	...	...	0.03 - 0.17 mm (0.0011 - 0.0066 in)
No 4	...	...	...	0.05 - 0.19 mm (0.0019 - 0.0074 in)
Crankshaft end float	...	...	...	Taken by flange of No. 1 main bearing and adjusted by shims
End float limits	...	...	...	0.07 - 0.13 mm (0.0027 - 0.0051 in)
Main journal maximum ovality	...	...	...	0.03 mm (0.0011 in)
<b>Crankcase</b>				
Main bearing bore diameters Nos 1, 2 and 3	...	...	...	65.00 - 65.03 mm (2.559 - 2.5601 in)
No 4	...	...	...	50.00 - 50.04 mm (1.9685 - 1.9700 in)
Oil seal bore diameter (flywheel end)	...	...	...	90.00 - 90.05 mm (3.5433 - 3.5452 in)
Camshaft bearing bore diameter	...	...	...	27.5 - 27.52 mm (1.0825 - 1.0852 in)
Oil pump housing bore diameter	...	...	...	70.00 - 70.03 mm (2.756 - 2.758 in)
Tappet (cam follower) bore diameters	...	...	...	19.00 - 19.05 mm (0.748 - 0.750 in)
<b>Cylinders</b>				
Type	...	...	...	Single barrels - finned - cast iron
Distance between pair centres	...	...	...	112 mm (4.41 in)
<b>Cylinder heads</b>				
Type	...	...	...	Aluminium - 1 per pair of cylinders
Port arrangement	...	...	...	One exhaust port per cylinder. Once siamesed inlet port per pair of cylinders on 47 bhp engines. One inlet port per cylinder, with twin branch inlet manifold on 50 bhp engines.
<b>Gudgeon pins</b>				
Type	...	...	...	Fully floating, steel tube retained by circlips
Diameter	...	...	...	21.996 - 22.00 mm (0.8658 - 0.8661 in)
<b>Lubrication system</b>				
Type	...	...	...	Wet sump - pressure and splash
Oil filter	...	...	...	Wire gauze suction strainer in sump
Sump capacity	...	...	...	2½ litres (4.4 Imp pints)
Oil pump type	...	...	...	Twin gear
Oil pressure (SAE 30, 70°C at 2500 rpm)	...	...	...	42 p.s.i. (min 28 p.s.i.)
Oil pressure warning light	...	...	...	Comes on between 2 - 6 p.s.i.
Oil cooler	...	...	...	Pressure fed multitube type in cooling fan housing
Oil level dipstick	...	...	...	Upper mark, full. Lower mark, half full.
<b>Oil pump</b>				
Gear/body end clearance (no gasket)	...	...	...	0.1 mm (0.004 in) max.
Gear backlash	...	...	...	0 - 0.2 mm (0.008 in)
<b>Oil pressure relief valve</b>				
Spring length loaded at 7.75 kg (17 lbs)	...	...	...	23.6 mm (0.928 in)
<b>Oil pressure regulating valve</b>				
	...	...	...	Maintains bearing pressure at 28 p.s.i.
<b>Pistons</b>				
Type	...	...	...	Light alloy with steel inserts
Clearance in cylinder limits	...	...	...	0.04 - 0.20 mm (0.0015 - 0.008 in)
Number of rings	...	...	...	3 - two compression, one oil control
Ring/groove side clearance - top compression	...	...	...	0.07 - 0.12 mm (0.0027 - 0.0047 in)
lower compression	...	...	...	0.05 - 0.10 mm (0.0019 - 0.0039 in)
oil control	...	...	...	0.03 - 0.10 mm (0.0012 - 0.0039 in)
Piston oversizes available	...	...	...	0.5 mm and 1.0 mm (0.020 and 0.040 in)
Piston pin bore offset	...	...	...	1.5 mm (0.060 in)
<b>Piston rings</b>				
Top compression	...	...	...	
Thickness	...	...	...	2.5 mm (0.10 in)

Gap limit ...	...	...	...	...	...	...	0.3 - 0.9 mm (0.012 - 0.035 in)
Bearing face	...	...	...	...	...	...	Bevelled, angle facing top of piston
Lower compression							
Thickness	...	...	...	...	...	...	2.5 mm (0.10 in)
Gap limit ...	...	...	...	...	...	...	0.3 - 0.9 mm (0.012 - 0.035 in)
Bearing face	...	...	...	...	...	...	Parallel, lower edge cut back
Oil control							
Gap	...	...	...	...	...	...	0.25 - 0.95 mm (0.010 - 0.037 in)
<b>Tappets - (Cam followers)</b>							
Type ...	...	...	...	...	...	...	Cylindrical flat based
Diameter	...	...	...	...	...	...	18.96 - 18.89 mm (0.7463 - 0.7471 in)
<b>Pushrods and rocker arms</b>							
Pushrod type	...	...	...	...	...	...	Tube with hemispherical ends
Pushrod length	...	...	...	...	...	...	272.5 mm
Rocker arm bore size limits	...	...	...	...	...	...	18.00 - 18.04 mm (0.7086 - 0.7093 in)
Rocker shaft diameter size limits	...	...	...	...	...	...	17.97 - 17.95 mm (0.7073 - 0.7066 in)
<b>Valves</b>							
Inlet: head diameter	...	...	...	...	...	...	35.6 mm (August 1976 on 33.0 mm)
stem diameter	...	...	...	...	...	...	7.94 - 7.95 mm
seat width	...	...	...	...	...	...	1.3 - 1.6 mm
seat angle	...	...	...	...	...	...	44°
guide bore diameter	...	...	...	...	...	...	8.00 - 8.06 mm
maximum rock in guide	...	...	...	...	...	...	0.8 mm
Exhaust: head diameter	...	...	...	...	...	...	32.1 mm
stem diameter	...	...	...	...	...	...	7.92 - 7.94 mm
seat width	...	...	...	...	...	...	1.7 - 2.0 mm
seat angle	...	...	...	...	...	...	45°
Guide bore diameter	...	...	...	...	...	...	8.00 - 8.06 mm
maximum rock in guide	...	...	...	...	...	...	0.8 mm
Seat width correction angle - inner	...	...	...	...	...	...	75°
outer	...	...	...	...	...	...	15°
Rocker arm/valve clearance	...	...	...	...	...	...	0.15 mm (0.006 in) all-cold
<b>Timing</b>							
Inlet opens	...	...	...	...	...	...	7° 30' BTDC
Inlet closes	...	...	...	...	...	...	37° ABDC
Exhaust opens	...	...	...	...	...	...	44° 30' BBDC
Exhaust closes	...	...	...	...	...	...	4° ATDC
<b>NOTE:</b> Rocker arm to valve clearances are set at 1 mm (0.040 in) for the purpose of valve timing only.							
<b>Valve springs</b>							
Type ...	...	...	...	...	...	...	Single coil spring
Loaded length	...	...	...	...	...	...	31 mm at 53-61 kg (116 - 134 lbs)
<b>Torque wrench settings</b>							
							<b>lbs ft</b> <b>m kg</b>
Crankshaft pulley nut	...	...	...	...	...	...	33              4.5
Oil pump nuts	...	...	...	...	...	...	14              2.0
Oil drain plug	...	...	...	...	...	...	33              4.5
Oil strainer cover nuts	...	...	...	...	...	...	5                0.7
Rocker shaft nuts	...	...	...	...	...	...	18              2.5
Cylinder head nuts	...	...	...	...	...	...	23 or 25      3.2 or 3.5
Flywheel bolt	...	...	...	...	...	...	253            35
Crankcase nuts & screws							
MB	...	...	...	...	...	...	14              2
M10	...	...	...	...	...	...	25              3.5
Connecting rod cap nuts	...	...	...	...	...	...	24              3.3
Engine securing nuts	...	...	...	...	...	...	22              3.0

## 1 General description and type identification

The 1600 version of the established 'Beetle' engine was introduced into the transporter range in 1967. The basic configuration of the 'Beetle' engine is unchanged - the cooling system incorporating the superimposed type of fan and housing. Modifications were made to the lubrication system by fitting an additional spring loaded valve which maintains oil pressure at the crankshaft bearings. In 1970 further modifications increased the power output and at the same time the cooling system was

improved by fitting a larger capacity fan and moving the oil cooler.

As a guide to identification the engines have prefix letters to their 7 figure serial numbers. These numbers are to be found on the crankcase at the base of the generator pedestal

B -47 bhp(DIN)

AD - 50 bhp (DIN) (1971 onwards)

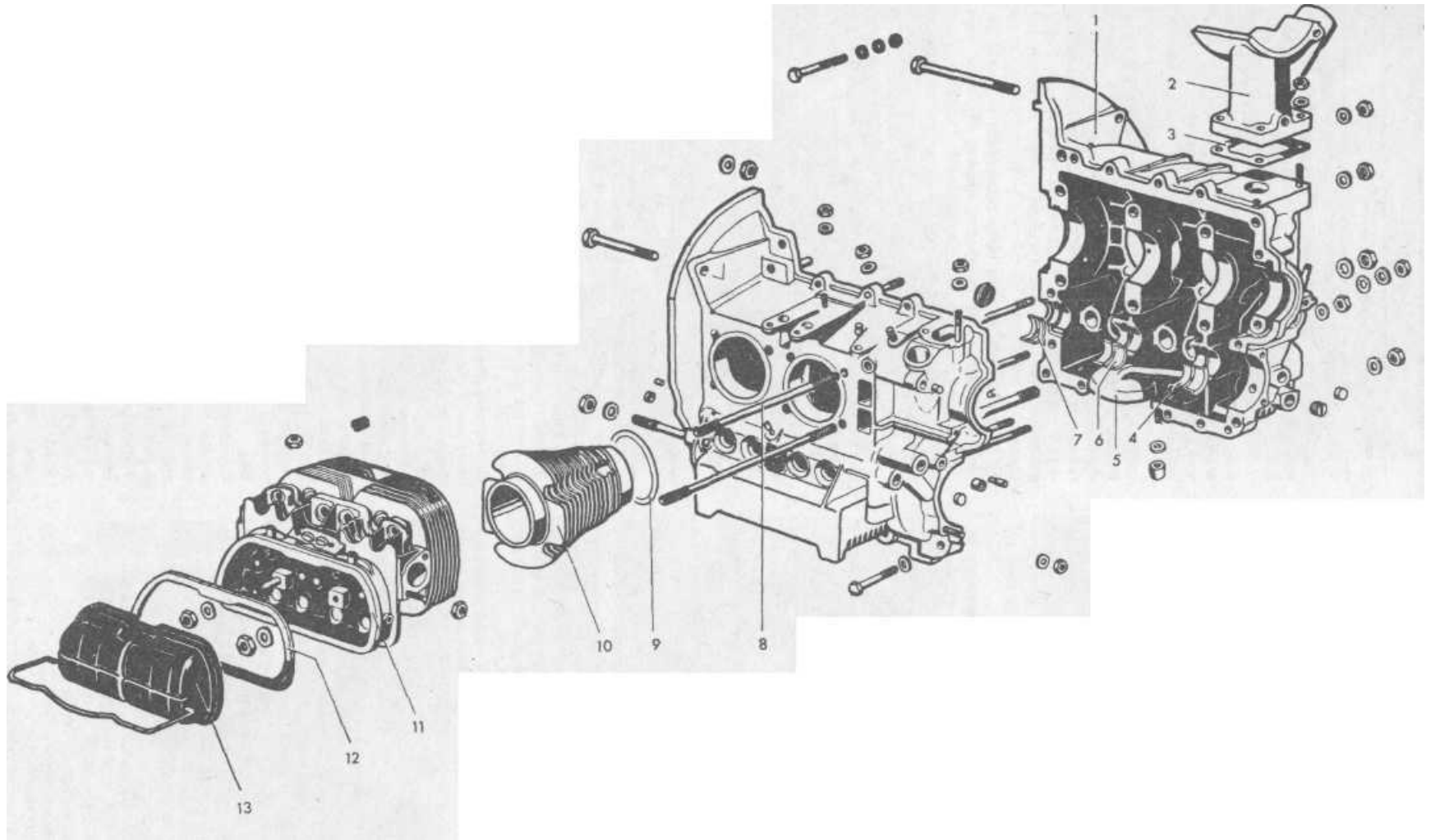
AE - 50 bhp (DIN) - emission control

AF - Low compression 6.6 : 1

AS - August 1974 on - compression ratio 7.5 : 1

The engine is an air-cooled horizontally opposed flat four





**FIG.1.1 ENGINE STATIC PARTS • EXPLODED VIEW**

1 Crankcase - right half  
2 Generator pedestal  
3 Gasket

4 Camshaft bearing - shell - rear  
5 Oil selector pipe

6 Camshaft bearing shell - centre  
7 Camshaft bearing shell - front

8 Cylinder head stud  
9 Cylinder base sealing

gasket  
10 Cylinder barrel

11 Cylinder head  
12 Rocket cover gasket  
13 Rocker cover

cylinder design. The short crankshaft runs in aluminium alloy shell bearings located between the two halves of a magnesium alloy crankcase which join vertically. The camshaft runs centrally below the crankshaft and is gear driven from the rear end of the crankshaft. The camshaft is also located between the crankcase halves and runs in removable split shell bearings.

The distributor is driven by a removable shaft from a gear mounted on the rear end of the crankshaft. The same shaft incorporates a cam which operates the fuel pump operating plunger rod.

The gear type oil pump is mounted in the rear of the crankcase, held between the two halves and driven by a horizontal shaft. A tongue on the inner end of the shaft engages in a slot in the end of the camshaft.

Four finned cylinder barrels are separately mounted and each pair has a common cylinder head containing the valves and rocker gear. The pushrods locate in cylindrical flat faced cam followers at the camshaft end and pass through sealed cylindrical tubes clamped between the head and crankcase outside the cylinder barrels. Each rocker cover is held to the head by spring hoops locating in a recess in the cover.

The flywheel is located on the front of the crankshaft by four dowel pegs and secured by a single central bolt which also incorporates needle roller bearings for the gearbox input shaft. The front crankcase oil seal bears on the centre hub land of the flywheel. The rear end of the crankshaft has an oil thrower plate and a helical groove machined in the pulley wheel hub to contain the oil. An oil filter screen is mounted in the bottom centre of the crankcase and the oil suction pipe for the pump comes from the centre of it. There is no other form of oil filter incorporated. The generator, which is mounted on a pedestal above the engine, is driven by a V-belt from the crankshaft pulley. On the forward end of the generator shaft the cooling fan is mounted. This runs in a sheet steel housing which ducts air down to the cylinder barrels.

There is no separate oil sump - the crankcase acting as an oil reservoir of just under 4¼ pints.

Engine cooling is regulated by a bellows type thermostat which is mounted in the air flow under the right hand pair of cylinders. The thermostat operates two linked control flaps in the fan housing lower ducting section at left and right.

The car heating system is integral with the engine cooling and is achieved by directing air through ducts which shroud the exhaust pipes. Two flexible ducts lead from the fan housing to the heat exchangers - and then via two more ducts to the car interior.

The cooling system also incorporates an oil cooler which is a multi-tube heat exchanger mounted vertically on the crankcase. Air from the cooling fan is ducted past it.

## 2 Repair and maintenance procedure - dismantling

Apart from routine servicing and checking or replacement of ancillary components no attempt should be made to carry out engine repairs with the engine in the vehicle.

The removal and overhaul of the ancillary components are dealt with in the appropriate chapter (where illustrations will also be found). The following list gives an idea of what can be removed or repaired with the engine still in the vehicle.

Oil pressure relief and control valves - Chapter 1

Thermostat bellows Chapter 2

Exhaust manifold - Chapter 2

Fan/generator assembly - Chapter 2

Carburettor - Chapter 3

Fuel pump - Chapter 3

Inlet manifold - Chapter 3

Distributor - Chapter 4

Distributor drive shaft - Chapter 4

Coil - Chapter 4

Generator (with fan) - Chapter 10

Starter motor - Chapter 10

## 3 Engine removal - preparation

Removal of the engine is straightforward enough provided there are proper metric tools available - or their nearest A.F. equivalents which are a satisfactory fit for many of the larger size requirements.

If a crane capable of lifting the rear of the vehicle is available the engine may be removed from underneath by disconnecting it after supporting it on a trolley jack, lifting the vehicle away from the engine and then lowering the engine to the ground and withdrawing it to the rear. However, the vehicle weighs just under a ton. The necessity of lifting it can be avoided by removing the rear engine compartment cross panel and the rear bumper. The engine can then be supported on a trolley jack, disconnected, and withdrawn to the rear while the vehicle remains on its road wheels. Do not try makeshift methods, the engine weighs 240 lbs and the engine casing is both fragile and expensive. This removal is discussed in detail in Section 4 of this chapter.

If the vehicle is very dirty underneath it would be well worthwhile getting it thoroughly cleaned off away from the removal area first. The lower mounting stud nuts are exposed to the elements and the top bolts and nuts call for a certain amount of reaching around. If you are working on your back at floor level, dirt falling in the eyes can be a major irritation.

It is possible to get the engine out and clear single-handed if all the equipment is available but the trickiest part is lowering the engine to floor level. Assistance is insurance against dropping it. Even a few inches fall could crack the aluminium crankcase - there being no conventional sump. Note that the engine is back-to-front as compared with a conventional layout so that the flywheel is nearer the front of the vehicle. All references to front and rear of the engine will, therefore, be in relation to its position in the car.

## 4 Engine - removal

1 Stand the vehicle on a hard level surface with sufficient room at the rear to draw the engine back. The wheels should be raised about 5 inches on blocks as this will give complete clearance in the opening in the rear when the engine is pulled back.

2 Disconnect the battery. Now is the time to drain the engine oil; whilst the ancillaries are being disconnected as described next.

3 Remove the carburettor air cleaner by undoing the hose securing clip at the carburettor end of the intake pipe, pulling the other hoses off their connections, and releasing the three securing clips holding the cleaner to the support bracket. On earlier models disconnect the wire control cable to the air intake flap. Do not tilt the cleaner too much or the oil will drip out.

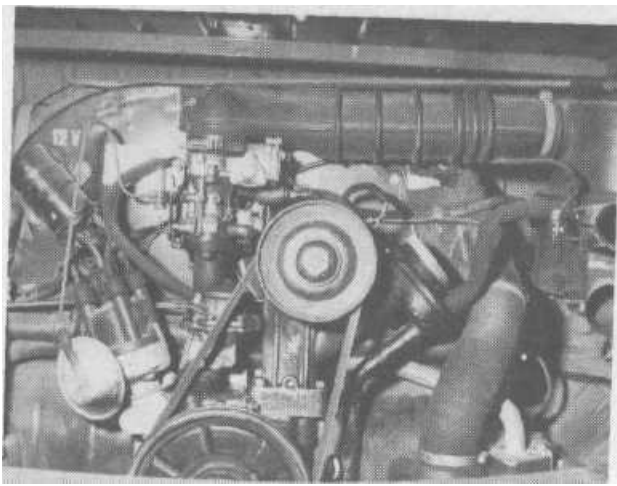
4 Disconnect the accelerator cable from the carburettor by undoing the clamp screw and drawing the cable out.

5 Detach two cables from the generator, one from the coil (from the side of the engine compartment), one from the oil pressure switch and two from the automatic choke and the cut-off valve of the carburettor. Tuck them out of the way to one side.

6 Remove the compartment cross panel by undoing the screws on the compartment floor and the bolts from the panel behind the bumper. Pull the rubber weatherstrip out of the groove and then lift the panel out (photo). On later models, the cross panel is of different design and is not detachable.

7 Remove the engine upper securing nuts and bolts. They are behind (in front of!) the fan housing and the nut is at the end of the bolt on the right hand side. On the left hand side there may be a nut too, but some models have a bolt which screws into a threaded lug in the casting and this can only be undone from the other side underneath. Under normal circumstances the bolt heads are captive and will not turn when the nuts are undone.

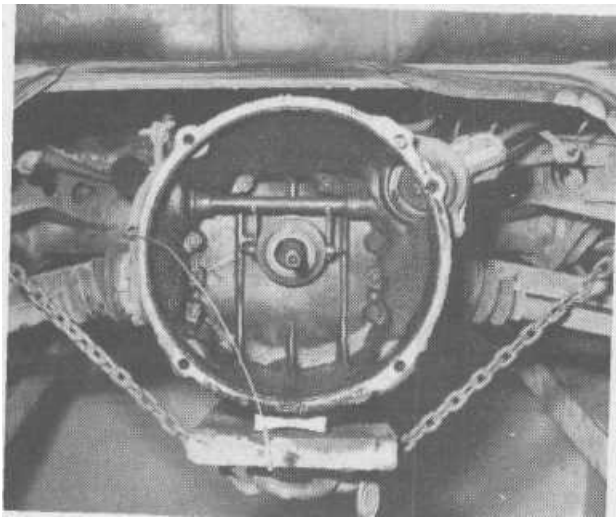
8 Now get underneath. Pull off the flexible fuel pipe (from the engine end, not the tank end) and clamp it with a self grip or



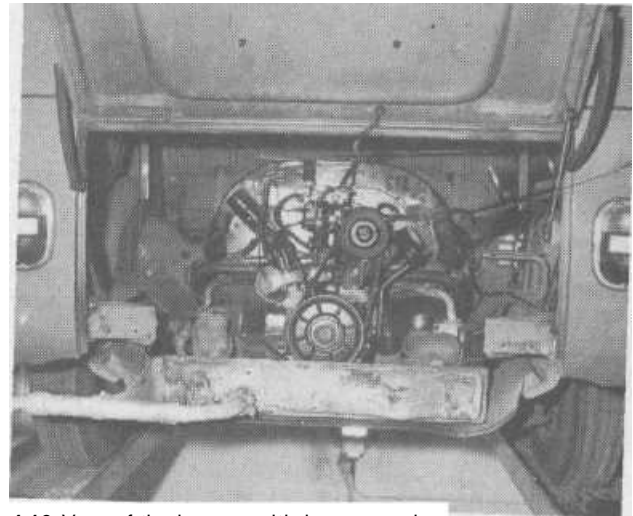
4.1 Open the engine cover and have a good look round.



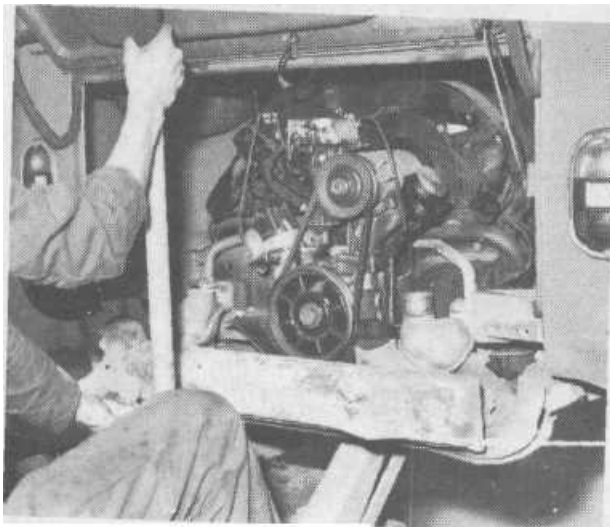
4.6 Removing the cross panel (early models)



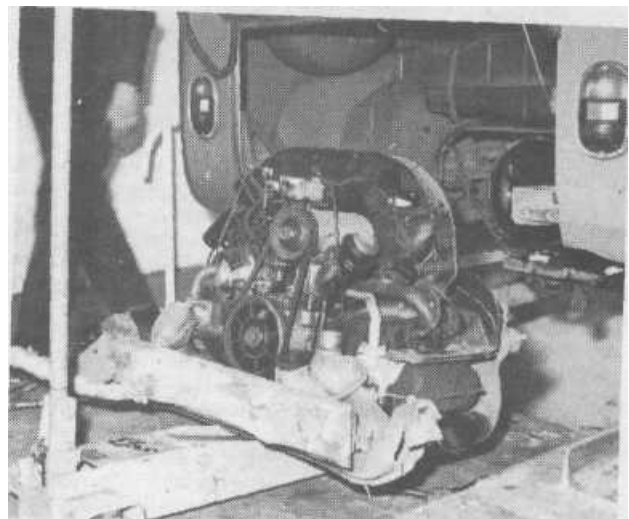
4.12 Support the gearbox with a piece of rope or chain. Note the wooden packing piece.



4.16 View of the bumper with bumper and cross member



4.18A Removing the engine on a trolley jack



4.18B Engine lowered to the floor.

plug it with a pencil or punch. Fuel is gravity fed.

- 9 Pull off the heater pipe connection hoses.
- 10 Disconnect the heater flap cables.
- 11 Pull the accelerator cable through the fan housing.
- 12 Support the gearbox with a piece of rope, wire or chain slung from the body side members under the floor. Do not support it on a jack as you may wish to move the vehicle afterwards. Support the gearbox to the rear of the drive shafts (photo).
- 14 Remove the lower engine securing nuts (photo).
- 15 If the left hand top bolt is one which screws direct into the crankcase remove it now.
- 16 Remove the two large bolts holding the rear bumper brackets to the side rails. Then take out the two bolts at each side securing the valances to the wing panel. The upper ones are fitted into captive nuts on the bumper valance. The lower ones are small nuts and bolts which will be almost certainly rusted solid and have to be cut off. Pull out the bumper (photo).
- 17 Remove the lower engine mounting bolt from each end of the engine support bracket (photo).
- 18 Place the trolley jack with the head under the centre of the crankcase and lift the engine a fraction to take the weight. It will then have to be pulled back about 4 inches so as to draw the clutch assembly off the gearbox input shaft and also to clear the rear engine mounting brackets. This may call for some rocking from side to side to achieve. When the engine is clear of the gearbox and the mountings lower it and draw it out from the rear (photos).

### 5 Engine dismantling-general

- 1 Unlike the majority of conventional engines the Volkswagen is one which does not make it easy to carry out most tasks with the engine still in the car. In view of the relative ease with which it can be taken out and lifted on to a bench this manual does not recommend that engine repair work of any significance is carried out with the engine still in the vehicle. If you have a pit or ramp that enables you to work conveniently under the car there are instances when it is justifiable. Otherwise the inconvenient 'flat on your back' method is far too risky in view of the likelihood of dirt getting into the wrong places and mistakes occurring.
- 2 For an engine which is obviously in need of a complete overhaul the economies against a replacement engine must also be carefully considered. The dismantling and reassembly of a Volkswagen engine is more complex than for a normal four cylinder block. Each cylinder is separate and the crankshaft and camshaft run in bearings mounted between the two halves of a precision faced, split crankcase. The number of individual parts is far greater. It is not our intention to put you off - far from it - but we must, in fairness to the owner, point out that it is much easier to make an assembly mistake than on a conventional engine.
- 3 The dismantling, inspection, repair and reassembly as described in this Chapter follows the procedure as for a complete overhaul.
- 4 Before starting work on any part it is strongly recommended that time is spent in first reading the whole Chapter. It would be too cumbersome and confusing to cross reference the implications of each and every activity. So if you think that the big end bearings are your problem, for example, do not think that **by** turning to the heading 'Big end bearings' all the implications of repairing them will be contained in that single section. Mention will be made in brief of the operations necessary which **may** lead up to it and the details of these should be read first.
- 5 Whatever degree of dismantling is carried out, components can only be examined properly after they have been thoroughly cleaned. This is best carried out using paraffin and a stiff bristled brush. Some engines can be particularly bad, with a stubborn coating of hard sludgy deposits - generally denoting neglect of regular oil changing - and it can take some time and effort to get this off. Afterwards, the paraffin can be hosed off with a water jet. Cleaning may sometimes seem to take a disproportionate amount of **time** but there is no doubt that it is time well spent.

### 6 Engine ancillaries - removal

Having removed the engine from the car it may be assumed that all the tinware will have to come off before any major overhauls are carried out. Once the fan housing assembly is removed together with the manifolds and heat exchangers and the support beam (photo), the dismantling of the other components is dealt with in this Chapter.

### 7 Oil cooler - removal and renovation

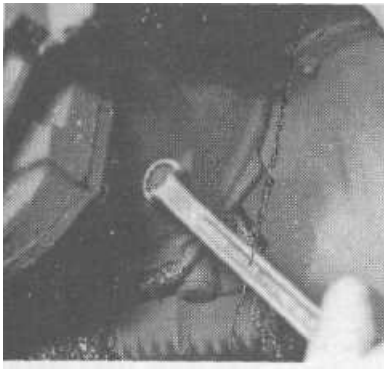
- 1 Remove the fan housing (Chapter 2).
- 2 The oil cooler is either mounted direct onto the crankcase or by means of an adaptor, depending on whether it is a 1970 or 1971 model.
- 3 In the case of the former undo the one upper and two lower nuts securing the cooler. In the latter case undo the nuts securing it to the adaptor.
- 4 It will be fairly obvious if the cooler leaks severely but if there is no apparent damage it may be difficult to decide whether it functions correctly. If suspect it should be subjected to a pressure test by a Volkswagen agent with the proper equipment. If there is any doubt about it the only sure remedy is a new one. If the cooler is found to be leaking the oil pressure relief valve should also be checked as it could have caused the failure of the cooler.
- 5 It is rare for the fins of the cooler to get clogged up but if they have, soak them in a solvent such as 'Gunk' and then flush and blow them through with a high pressure air line. Do not try and poke dirt out with sharp pointed implements.

### 8 Oil pressure relief and control valves - removal and renovation

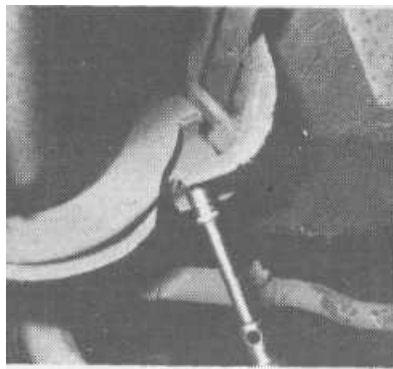
- 1 These may be removed from underneath with the engine in the car. They are spring loaded pistons held into the left hand half of the crankcase at front and rear by large screw plugs (photo).
- 2 It is not necessary to drain the engine oil but be prepared to catch a small quantity when either of the valves is removed.
- 3 When the plugs are removed the springs and plungers should drop out. If a plunger sticks in the bore in the crankcase it may need a little assistance and poking with a screwdriver.
- 4 If a piston seems seized and will not move it may be necessary to start the engine. Oil pressure should blow it out. Such drastic action being necessary would indicate serious neglect in the matter of regular oil changes. Note that the plungers and springs are not interchangeable so do not mix them up (photo).
- 5 Both pistons should be a sliding fit in the crankcase bores. Minor signs of seizure may be cleaned up. If there is severe scoring in the piston it may be renewed but if the crankcase bore is damaged the consequences could be serious and expensive, calling for a new one also.
- 6 The larger of the two springs is for the oil pressure relief valve and goes into the rear bore near the oil pump (photo). The shorter spring is for the pressure regulating valve and goes into the front bore near the transmission mounting (photo).
- 7 When refitting ensure that the springs locate in their recesses in both piston and plug and that a new plug seal is used. The relief valve serves to relieve excessive oil pressure from the oil cooler when the oil is cold and thick. The regulating valve serves to maintain oil pressure at the crankshaft bearings when the oil is hot and thin.

### 9 Crankshaft pulley wheel - removal and replacement

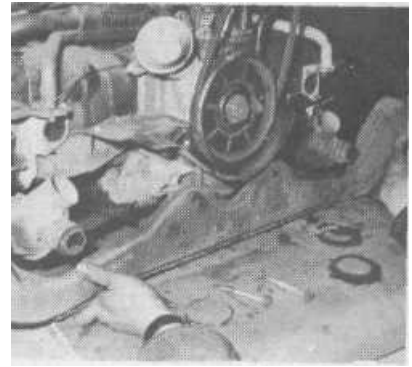
- 1 Take off the cover plate held by three screws.
- 2 The pulley wheel is a straight keyed fit on the end of the crankshaft. It is secured by a single, central bolt. To lock the



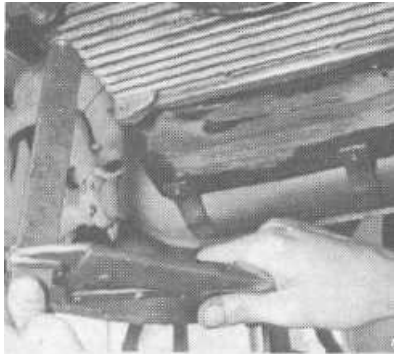
4.14 Remove the engine securing nuts



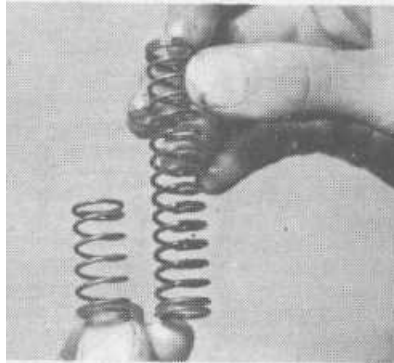
4.17 Removing one of the lower engine mounting bolts - do not forget the other one



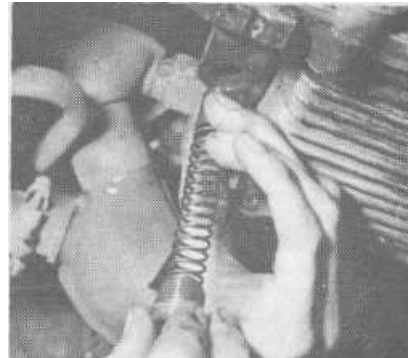
6.1 Removing engine rear support beam



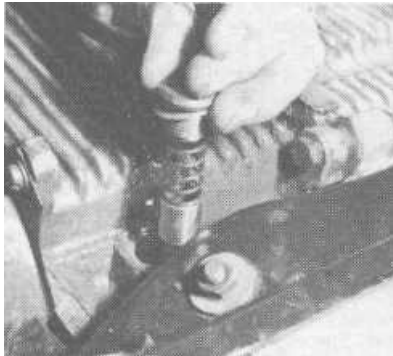
8.1 Undo stubborn oil pressure regulator plugs with an improvised screwdriver.



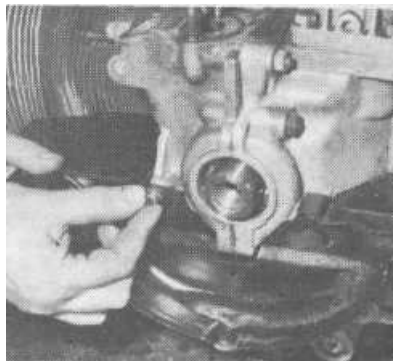
8.4 The relief valve spring is longer than the regulator valve spring.



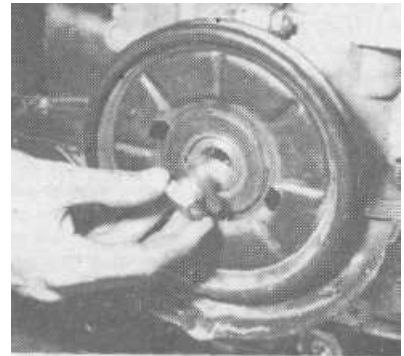
8.6a Replacing the relief valve piston spring and plug.



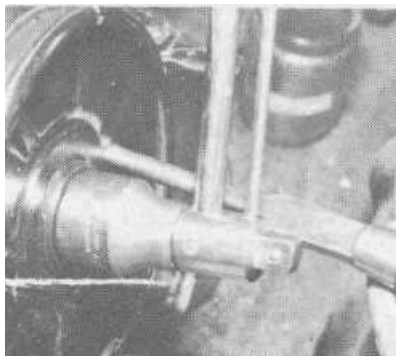
8.6b Replacing the regulator valve piston, spring, and plug.



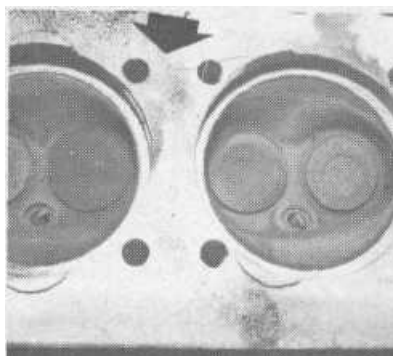
9.3 Fitting the lower cover before the crankshaft pulley.



9.4a Replace the pulley nut



9.4b Tighten the pulley nut.



12.6 The head to cylinder joint has been 'blowing', probably due to the stud not having been tightened down properly.



pulley when undoing or tightening the bolt push a suitable article through one of the holes in the pulley and jam it against the crankcase flange.

3 If, when the nut has been removed, the pulley is a very tight fit, do not apply force at the edges or you are likely to distort it. Soak the boss with penetrating oil and hook something through the two holes if any leverage is necessary.

4 If the pulley has been removed during the course of an overhaul remember that the lower rear engine plate has to be re-fixed before the pulley (photo). There is no access to the two securing screws after the pulley is in position.

5 The nut should be tightened to a torque of 33 ft/lbs when the pulley has been replaced (photos), and Fig.1.5.

### 10 Oil pump - removal and renovation

1 Remove the crankshaft pulley wheel and the lower rear cover plate.

2 The oil pump gears may be removed relatively easily because once the oil pump cover plate has been released by removing the four retaining nuts, the gears may be drawn out of the pump body.

3 The pump body itself is mounted over the same four studs as the cover plate and is clamped between the two halves of the crankcase. To remove the pump body from the engine without splitting the crankcase is best done with a special tool which fits over the studs, locks to the inside of the body and draws it out. If you do not have such a tool then the best way is first to slacken the crankcase clamping stud nuts above and below the pump. This relieves the pressure on the body. A suitable tool can then be tapped against the edge of the pump body and, in easy stages, it can be eased out over the studs. Do not force a tool into the gap between the pump body and the crankcase as this could damage the mating faces and upset the correct alignment of the pump on replacement.

If the crankcase is to be split anyway leave the pump body to be taken out then.

4 It is possible to check the pump fairly comprehensively without removing the body from the crankcase but it is, of course, far less convenient and liable to cause measurement inaccuracies.

5 First check the cover plate. If it is very badly scored it should be renewed anyway. Light scoring can be ground out using carborundum paste on a piece of plate glass.

6 Check that the driving spindle is a good fit in the body. Any apparent rocking indicates that the inside of the pump body must also be worn. The driven gear spindle should be tight in the body. The gear should be a good fit on it with no play.

7 Provided both gear spindles are in good shape refit the gears and measure the end clearance between them and the end of the pump body. This is done by putting a straight edge across the body and using a feeler gauge to measure the gap between the straight edge and the gears (See Fig.1.4). Make sure no traces of gasket remain on the flange of the body when doing this. The gap should not exceed 0.1 mm (0.004 inch) or inadequate oil pressure will result. The wear is most likely to be in the pump body in this case and this will need renewal.

### 11 Cylinder heads - removal

1 Take the engine out of the car

2 Remove the exhaust system, heat exchangers and upper cylinder cover plates as described in the Fuel and Cooling Chapters. The inlet manifold together with carburettor should also be taken off. See the Fuel system Chapter for details.

3 Prise off the spring clip, downwards, which clamps the rocker cover to the head. Take off the cover.

4 Undo the two nuts, evenly, which secure the rocker shaft pedestals and then pull off the pedestals, shaft and rockers as a complete assembly. Pull out the four pushrods and push them through a piece of cardboard so that the location of each one is

known and which is the top and bottom end.

5 Before starting to undo the eight nuts which hold the cylinder head down onto the cylinder barrels it must be appreciated that when the head is released the four pushrod tubes will be freed and the cylinder barrels also. If the cylinder barrels are not being taken off the pistons they will rest in position but the engine must not be turned. If the engine is to be turned the barrels should be temporarily tied down to the crankcase with string or wire. If the barrels are disturbed then they must be removed so that new cylinder base gaskets may be fitted (See Section 26).

6 Using a socket spanner, the cylinder head stud nuts should be slackened  $\frac{1}{2}$  to  $\frac{3}{4}$  turn each only, in the reverse order of the final tightening sequence as given in Fig.1.12. Continue releasing each nut a little at a time until they are all slack. When all are removed the head may be drawn back a little way.

7 Remove the pushrod tubes from between the head and crankcase and make sure the cylinders are disengaged from the head before pulling the head right off.

### 12 Cylinder heads - dismantling and renovation of rocker gear, valves and springs

1 To remove the rocker arms from the shaft the spring clips at each end should be removed and the thrust washers and wave washers taken off. The end rockers may then be removed. The rocker shaft support pedestals may need tapping off if they are tight in order to remove the two inner rocker arms, clips and washers. If possible lay out the parts in the order in which they were dismantled in a place where they need not be disturbed.

2 To remove the valves it is necessary to use a proper tool to compress the valve springs. The tops of the springs are almost level with the edge of the head casting. If you are unable to obtain a G clamp with extended ends (to clear the edge of the head when the spring is compressed) it will be necessary to use a short piece of tube, with an aperture cut in the side, in conjunction with a conventional spring compressor. The aperture is to enable one to get at the split collets on the valve stem.

3 Compress the spring using the clamp and if the tubular spacer is being used make sure that the pressure is applied squarely and that the tube cannot slip. As soon as the two split conical collars round the valve stem are revealed, use a small screwdriver through the aperture to hook them off the valve stem. It is advisable to maintain one's hold on the spring clamp while doing this to prevent anything from slipping. When the collets are clear release the spring clamp.

4 The spring retainer collar and spring may then be lifted off. There may be small sealing rings round the valve stems and these too should be taken off. The valve can now be pushed through the guide and taken out. If it tends to stick then it will be because of carbon or sludge deposits on the end of the valve stems and these should be cleaned off as necessary. The end of the valve stem could also be burred due to the 'hammering' action of the rocker arm; in which case the burrs should be carefully stoned off. Do not force a tight valve through the guide or you will score the guide. Keep valves in order so that they may be replaced in the same port. Push them through a numbered piece of cardboard to avoid getting them mixed up.

5 After the cylinder head has been removed and the valves taken out, the head itself should be thoroughly cleaned of carbon in the combustion chamber and examined for cracks. If there are any visible cracks the head should be scrapped. Cracks are most likely to occur round the valve seats or spark plug holes. Bearing in mind that one head will cost (new) nearly 20% of the cost of a complete replacement engine economies should be considered as well as the likelihood of obtaining a used head from a breaker's yard. If the latter, make sure that the head you get is the same type as the old one - and in better condition!

6 Occasions occur when the head has been removed because of 'blowing' between the head and cylinder (photo). This is usually caused when head studs and nuts have not been tightened to the correct torque or tightened unevenly. Provided there are no signs

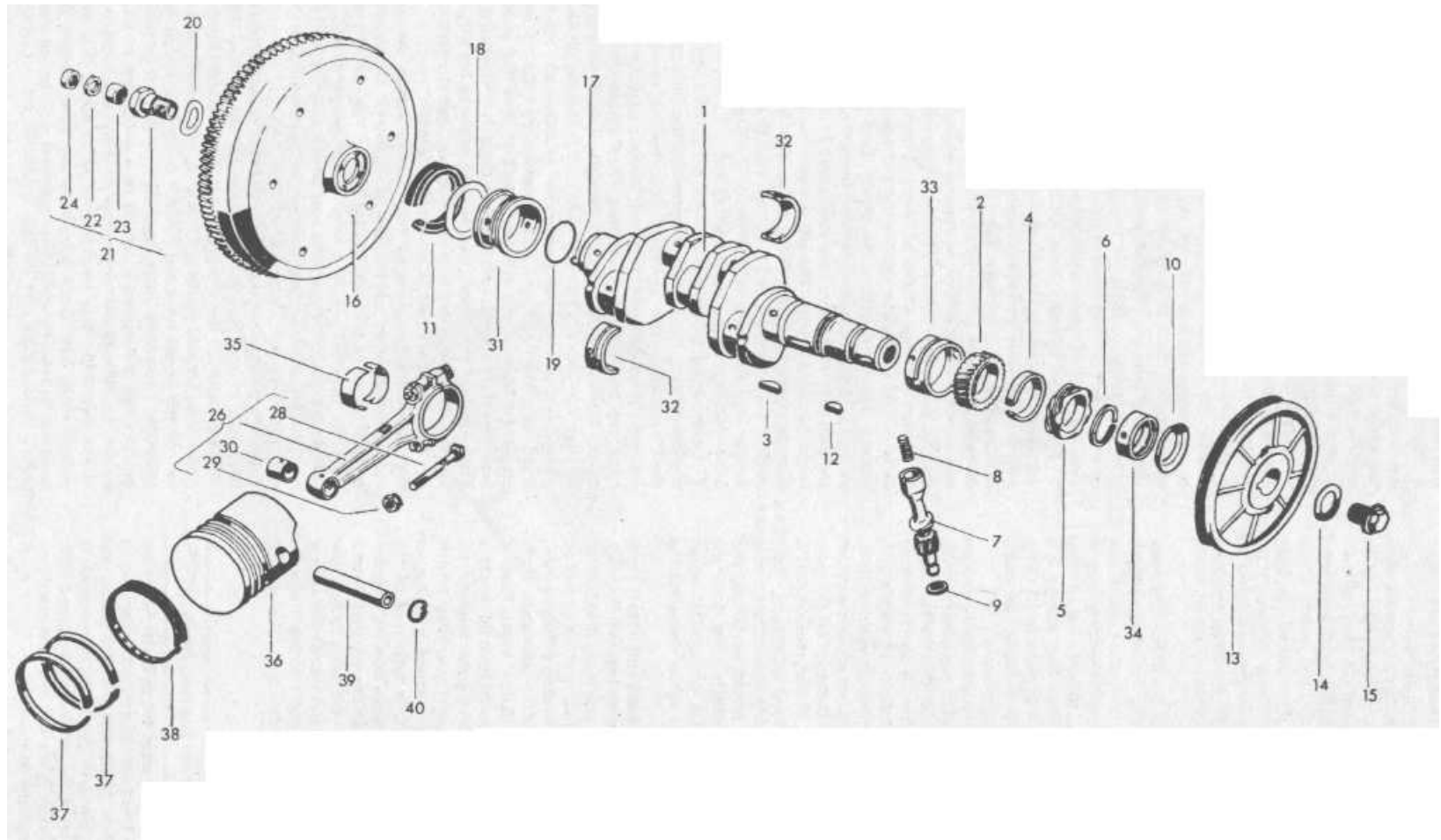


FIG.1.2 ENGINE RUNNING PARTS - EXPLODED VIEW

- |                     |                      |                   |  |                   |                             |
|---------------------|----------------------|-------------------|--|-------------------|-----------------------------|
| 7 Crankshaft        | shaft                | 14 Washer         | 21 Hollow bolt with<br>needle roller bearing | 28 Con rod screw  | 35 Big end bearing<br>shell |
| 2 Crankshaft gear   | 8 Spring             | 15 Bolt           | 22 Sealing washer                            | 29 Nut            | 36 Piston                   |
| 3 Woodruff key      | 9 Washer             | 16 Flywheel       | 23 Needle roller<br>bearing                  | 30 Small end bush | 37 Piston ring              |
| 4 Spacer            | 10 Oil baffle washer | 17 Dowel          | 24 Collar                                    | 31 Main bearing   | 38 Scraper ring             |
| 5 Distributor drive | 11 Oil seal          | 18 Spacer         | 26 Con rod                                   | 32 Bearing shell  | 39 Gudgeon pin              |
| 6 Securing ring     | 12 Key for pulley    | 19 Locking washer |  | 33 Main bearing   | 40 Circlip                  |
| 7 Distributor drive | 13 Crankshaft pulley | 20 Locking washer |  | 34 Bearing shell  |                             |

of severe burning at the sealing area in the head then the cylinder can be lightly ground in with carborundum paste. However, it should be understood that the depth to the mating face for each cylinder should be equal (give or take 3 to 4 thousandths of an inch) otherwise the head will not seat level on both cylinder barrels and leaks will recur. If both parts of the head are ground equally to level things up remember that you will have to check piston clearance and that you will also have raised the compression ratio. Facilities do exist (in Germany anyway!) for reconditioning cylinder heads and fitting aluminium shims of 0.8, 1.0 or 1.5 mm thickness as necessary. In exchange engines 1 mm steel shims are fitted as standard on reconditioned heads, but these are not available as spares.

7 The valve seats should be examined for signs of burning away or pitting and ridging. If there is slight pitting the refacing of the seats by grinding in the valve with carborundum paste will probably cure the problem. If the seat needs re-cutting, due to severe pitting, then the seat width should not exceed specification (see Fig.1.7). Fitting new valve seat inserts is a specialist task as they are chilled and shrunk in order to fit them. Check with the nearest Volkswagen dealer because you could have difficulty in getting this problem solved cheaply.

8 The rocker gear should be dismantled and thoroughly cleaned of the sludge deposits which normally tend to accumulate on it. The rocker arms should be a smooth fit on the shaft with no play. If there is any play it is up to the owner to decide whether it is worth the cost of renewal. The effects on engine performance and noise may not be serious although wear tends to accelerate once it is started. The valve clearance adjusting screws should also be examined. The domed ends that bear on the valve stems tend to get hammered out of shape. If bad, replacement is relatively cheap and easy.

9 The valves themselves must be thoroughly cleaned of carbon. The head should be completely free of cracks or pitting and must be perfectly circular. The edge which seats into the cylinder head should also be unpitted and unridged although very minor blemishes may be ground out when re-seating the valve face.

10 Replace the valve into its guide in the head and note if there is any sideways movement which denotes wear between the stem and guide. Here again the degree of wear can vary, if excessive, the performance of the engine can be noticeably affected and oil consumption increased. The maximum tolerable sideways rock, measured at the valve head with the end of the valve stem flush with the end of the guide, is 0.8 mm (0.031 inch). Wear is normally in the guide rather than on the valve stem but check a new valve in the guide if possible first. Valve guide renewal is a tricky operation in these cylinder heads and you may find it difficult to get it done. Check with the nearest Volkswagen dealer first. Do not attempt it yourself. One final part of the examination involves the end of the valve stem where the rocker arm bears. It should be flat but often gets 'hammered' into a concave shape or ridged. Special caps are available to put over the ends. Alternatively, the ends can be ground off flat with a fine oil stone. Remember that it is difficult to set the valve clearances accurately with the adjusting screw and valve stem in a battered condition.

### 13 Cylinders, pistons and rings - removal and renovation

1 The cylinders may be removed, after the cylinder heads are off, simply by drawing them from over the pistons. Mark which cylinder comes from where first. Make sure that the piston and rings are not damaged after the cylinder has been removed. It must also be remembered that if the crankshaft is turned after removing the cylinder the piston skirts can foul the crankcase unless they are guided at the bottom of the stroke.

2 The piston rings may be removed from the pistons by carefully spreading the ends of each ring so that it comes out of its groove and then drawing it off over the top of the piston.

3 To remove the piston it is necessary to separate it from the connecting rod as it is not possible to get at the connecting rod

bolts with the piston fitted.

4 Remove the circlip from one side of the piston boss where the gudgeon pin is retained and it will be possible to push out the gudgeon pin. If it resists then warm up the piston with an electric light bulb held next to it for a while. Do not try and drive out the gudgeon pin from a cold piston. You will possibly bend a connecting rod. It is only necessary to push out the pin far enough to enable the connecting rod to be released from the piston. If the pistons are to be put back make sure that each one is marked suitably so that you know (a) which number cylinder it came from and (b) which way faces forward. A good way is to scratch the number and an arrow, pointing forward, on the crown before removal. If you do make a nonsense and forget how it came off then carefully clean the top of the crown and look for identifying marks which indicate the front or flywheel side. Volkswagen pistons are stamped with an arrow at the edge of the crown pointing towards the flywheel. British made pistons have the word 'flywheel' stamped on in that position.

5 Piston and cylinder bore wear are contributory factors to excessive oil consumption (over 1 pint to 300 miles) and general engine noise. They also affect engine power output due to loss of compression. If you have been able to check the individual cylinder pressures before dismantling so much the better. They will indicate whether one or more is losing compression which may be due to cylinders and pistons if the valves are satisfactory.

6 The piston rings should be removed from the pistons first by carefully spreading the open ends and easing them from their grooves over the crown of the piston. Each one should then be pushed into the cylinder bore from the bottom using the head of the piston to make sure they rest square in position about 5 mm from the bottom edge. The gap between the ends of the ring can then be measured with a feeler gauge. For the two compression rings it should not exceed 0.90 mm (0.035 inch) and for the oil scraper ring 0.95 mm (0.037 inch). If the gaps are greater you know that new rings at least are required.

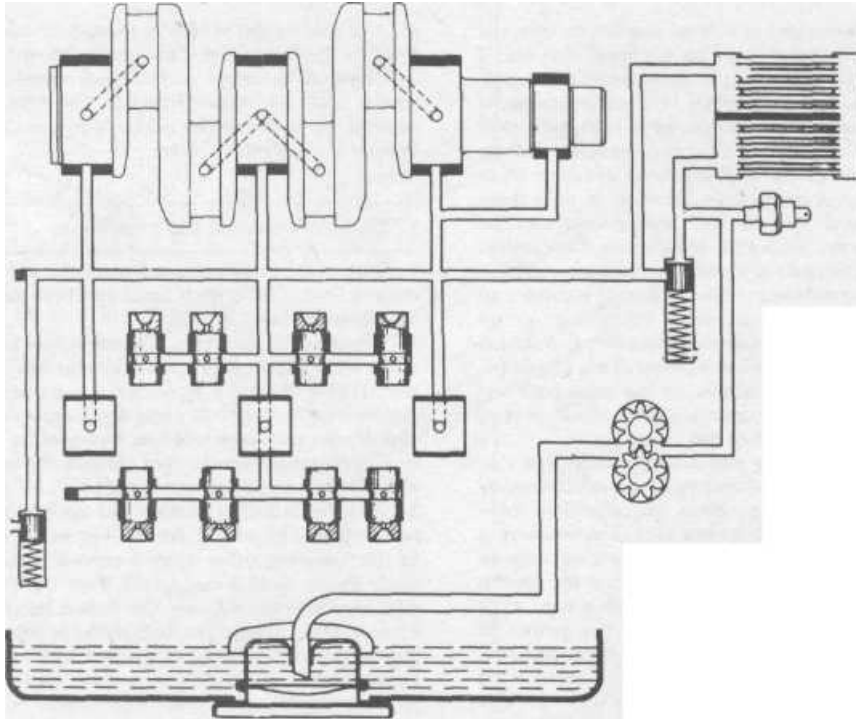
7 Determining the degree of wear on pistons and cylinders is complementary. In some circumstances the pistons alone may need renewal - the cylinders not needing reboring. If the cylinders need reboring then new pistons must be fitted. First check the cylinders. A preliminary check can be done simply by feeling the inside walls about JS inch down from the top edge. If a ridge can be felt at any point then the bores should be measured with an inside micrometer or calipers to see how far they vary from standard. The measurement should be taken across the bore of the cylinder about 15 mm (0.6 inch) down from the top edge at right angles to the axis of the gudgeon pin. Then measure the piston, also at right angles to the gudgeon pin across the skirt at the bottom. The two measurements should not differ by more than 0.20 mm (0.008 inch).

8 Further measurement of the cylinder across the bore will indicate whether or not the wear is mostly on the piston. If the cylinder bore is uniform in size fitting new pistons alone is possible. However, it is a very short sighted policy. If new pistons are needed anyway the cost of reboring will add 20-25% to the cost of the pistons so it would be as well to get it done whilst the cylinders are off.

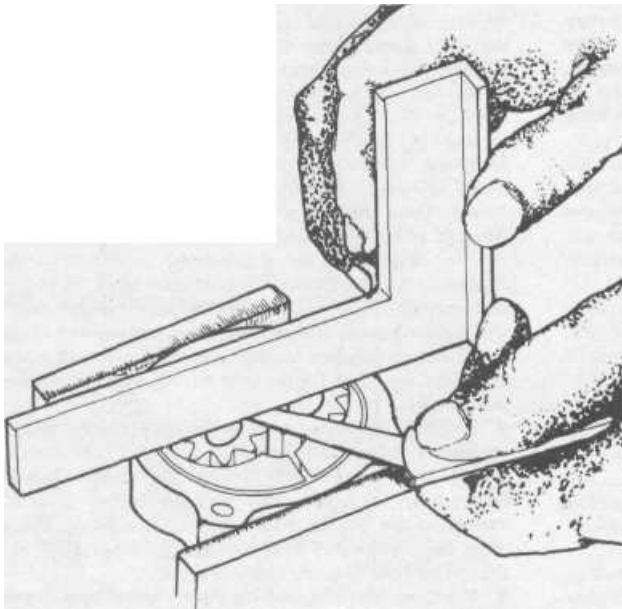
9 Another feature of the pistons to check is the piston ring side clearance in the grooves. This should not exceed 0.12 mm (0.0047 inch) for the top ring and 0.10 mm (0.004 inch) for the other two. Usually however, this wear is proportionate to the rest of the piston wear and will not occur in a piston which is otherwise apparently little worn. If you think that only a new set of rings is required it would be a good idea to take your pistons to the supplier of the new rings and check the new rings in the gaps. You may change your mind about how worn the pistons really are! Once a cylinder has been rebored twice it must not be rebored again. New cylinders must be obtained.

### 14 Connecting rods and bearings - removal and renovation

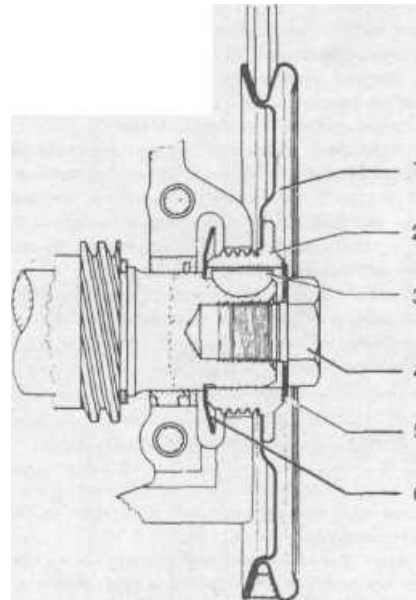
1 Connecting rods may be removed only after the pistons have been taken off. It is not necessary to split the crankcase although



**FIG.1.3 LUBRICATION SYSTEM - DIAGRAMMATIC DRAWING**



**FIG.1.4 MEASURING OIL PUMP GEAR END CLEARANCE (Sec 10)**



**FIG.1.5 CRANKSHAFT PULLEY WHEEL - CROSS SECTION (Sec 9)**

- |                     |                    |
|---------------------|--------------------|
| 1 Pulley            | 4 Securing bolt    |
| 2 Oil return scroll | 5 Lock washer      |
| 3 Woodruff key      | 6 Oil thrower disc |

if you are going to do so anyway it will be simpler to take the connecting rods off the crankshaft afterwards. Start with No. 1 and, using a socket with an extension, slacken the two connecting rod cap nuts by inserting the extension into the crankcase: It is important to have the crankshaft positioned so that the socket spanner fits squarely and completely onto the head of each nut. 2 Once both are loose, carefully undo each one and keep them captive in the socket when undoing them so as not to drop them in the crankcase. The cap will be left behind and may be awkward to retrieve. Tip the engine to shake it out if necessary. Retrieve both halves of the bearing shells also. Loosely refit the cap to the connecting rod noting the two matching numbers on the shoulders of the rod and cap which must line up on replacement. It is a good idea to note on a piece of paper which serial number applies to which cylinder number. This avoids the need to mark the connecting rods further. If the same rods and pistons are being put back it is very desirable that they should go back in the same position as they came out.

3 It is unlikely that a connecting rod will be bent except in cases of severe piston damage and seizure. It is not normally within the scope of the owner to check the alignment of a connecting rod with the necessary accuracy so if in doubt have it checked by someone with the proper facilities. It is in order to have slightly bent connecting rods straightened - the manufacturers provide special jigs for the purpose. If a rod needs replacement, care should be taken to ensure that it is within 10 grams in weight of the others. If too heavy, connecting rods may be lightened by removing metal from the shoulders near the big end of the wiper parts where the bearing cap mates up to it.

4 The small end bushes are also subject to wear. At a temperature of 70°F the piston (gudgeon) pin should be a push fit. No axial or rocking movement should be apparent. The fitting of new bushes is a specialist task and although the bushes themselves may be easily pressed in it is necessary to ream them to fit the gudgeon pins. Unless you have reamers readily available and the knowledge of how to use them this should be done by a firm (or individual) specialising in engine reconditioning. Remember that if you are fitting new pistons it may be necessary to fit new connecting rod bushes. If you are lucky the new gudgeon pins may fit the old bushes properly however. Make sure that the new bushes have been drilled to match the oil holes in the connecting rod. This should be done before reaming so that there are no burrs on the bush bore.

5 The shell bearings from the big end are matt grey in colour when in good condition. If the engine has done a considerable mileage it is good policy to renew them anyway when the opportunity presents itself. To make sure you get the correct replacement size make a note of the numbers on the back of the bearing shell or take it along to the supplier.

6 If the crankshaft is being reground new bearing shells will be required anyway and these are normally available from the firm which does the regrinding and will be matched to the degree of regrinding carried out.

### 15 Camshaft and tappets - removal and renovation

1 The camshaft and tappets can be removed only after splitting the crankcase and this procedure is described in the section on crankshaft removal.

2 Having split the crankcase the tappets should be checked in their respective bores in the crankcase and no excessive side-play should be apparent. The faces of the tappets which bear against the camshaft lobes should also have a clear, smooth shiny surface. If they show signs of pitting or serious wear they should be renewed. Refacing is possible with proper grinding facilities but the economics of this need investigating first. The lobes of the camshaft should be examined for any indications of flat spots, pitting or extreme wear on the bearing surfaces. Minor blemishes may be smoothed down with a 120 grain oil stone and polished with one of 300 grain. The bearing journals also should be checked in the same way as those on the crankshaft. The camshaft bearings are renewable.

3 The gear wheel which is riveted to the end of the camshaft must be perfectly tight and the teeth should be examined for any signs of breakage or excessive wear. It may be possible to have a new gear wheel fitted to the existing camshaft - much depends on the facilities available in your area. It is not a job to be attempted by the owner.

### 16 Flywheel - removal and renovation

1 With the engine removed from the car the flywheel may be removed after the clutch cover has been taken off (as described in Chapter 5. See Fig. 1.8.

2 The flywheel is held by a single centre bolt which is tightened up to 253 ft/lbs so do not think you can get it undone just like that. It was necessary to obtain a piece of angle iron to lock the flywheel by putting the angle iron across two of the clutch bolts which were put back into the flywheel. If by yourself the other end of the angle iron (or flat bar will do) can then be held in the vice with the engine on the bench.

3 A 36 mm socket is then put on the bolt with the longest handle from the socket set (do not under any circumstances try to use anything other than a correct sized socket - you could easily cause serious damage or even hurt yourself). A piece of steel pipe is then put over the socket handle and leaned on with considerable weight. The bolt slackens with no fuss at all. It may cost you a little money to get the stuff to do this job properly but we cannot recommend any other way.

4 Remove the bolt and large washer and before going any further make an identifiable mark on the flywheel hub so that you can re-locate the flywheel in the same place. The matching mark on the crankshaft cannot be made until the flywheel is off, so remember not to move the flywheel when it has come off until you can make a corresponding line up mark on the crankshaft flange. This is important as there may be no other way of knowing the correct position of balance.

5 The flywheel is now located only by four dowel pegs which fit into holes in the crankshaft flange and flywheel boss. Put a piece of wood under the edge of the flywheel starter teeth to support the weight and then use a soft mallet or block of wood to tap the edges of the flywheel and draw it off. Do not try and lever it off with anything against the crankcase or you are likely to crack the casting and that will be expensive.

6 When the flywheel is free, hold it steady, and remove the metal or paper gasket fitted over the four dowel pegs in the flange. Then make the second line-up mark on the crankshaft referred to in paragraph 4.

7 The dowel pegs are a precision fit into both the flange and flywheel. If any of these should be a slack fit there is considerable risk of the flywheel working loose, despite the tightness of the securing bolt. Where a flywheel has worked loose and caused the holes to become oval a new flywheel will be needed. (The precision work of boring and fitting oversize dowel pegs would cost more).

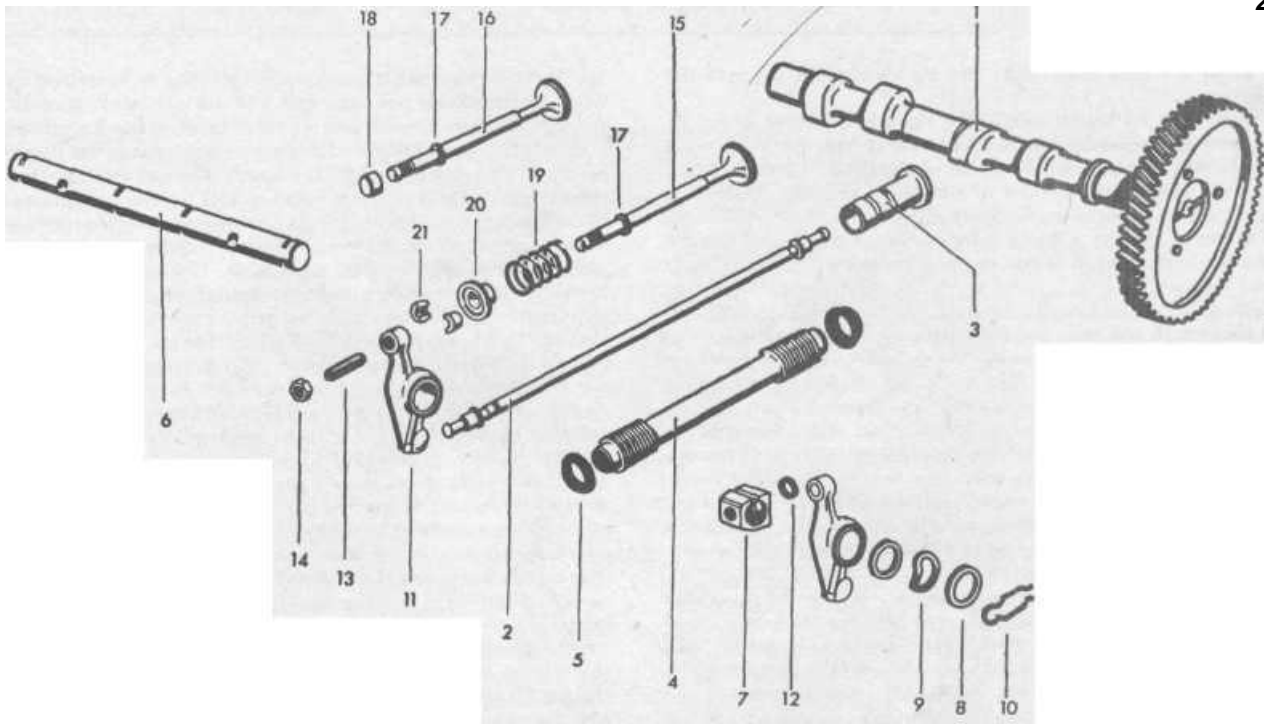
8 Another area of wear is in the starter teeth. These are machined into the flywheel itself so there is no question of fitting a new ring gear. If the teeth have become seriously chewed up it is in order to have up to 2 mm (0.08 inch) machined off on the clutch side of the teeth. The teeth should then be chamfered and de-burred. Any good machine shop should be able to carry out this work.

9 Examine also the land on the flywheel boss where the oil seal runs. If this is severely ridged it may need cleaning up on a lathe also. Any such ridging is very exceptional.

### 17 Crankshaft oil seal - removal

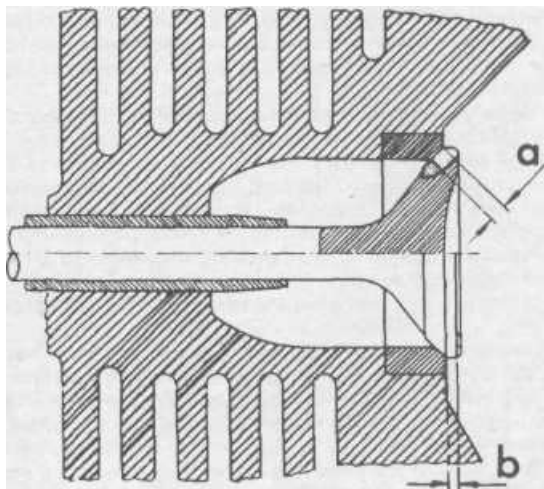
1 The crankshaft oil seal may be removed after taking the engine from the car and removing the flywheel.

2 The oil seal may be levered out of the crankcase with a screwdriver or similar but great care must be taken to avoid damaging the crankcase where the seal seats. This means that the



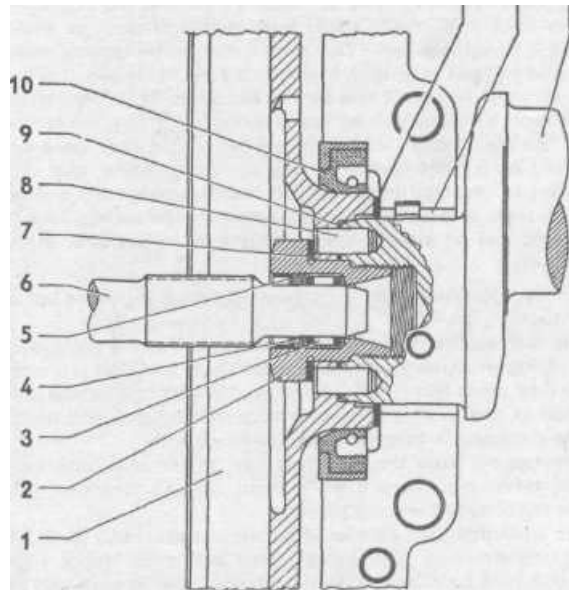
**FIG.1.6 CAMSHAFT AND VALVES- EXPLODED VIEW (Sec 15)**

- |                              |                         |                           |                        |
|------------------------------|-------------------------|---------------------------|------------------------|
| 1 Camshaft and gear assembly | 6 Rocker shaft          | 12 Sealing ring           | 17 Oil wiper           |
| 2 Pushrod                    | 7 Shaft support bracket | 13 Tappet adjusting screw | 18 Valve cap           |
| 3 Tappet                     | 8 Thrust washer         | 14 Locknut                | 19 Valve spring        |
| 4 Pushrod tube               | 9 Corrugated washer     | 15 Inlet valve            | 20 Valve spring seat   |
| 5 Pushrod tube seal          | 10 Securing clip        | 16 Exhaust valve          | 21 Valve cotter halves |



**FIG.1.7 VALVES - CROSS SECTION OF SEAT (Sec 12)**  
 a - seat width 1.7 - 2 mm exhaust and 1.25 - 1.65 mm inlet  
 b- 1 mm Minimum, all valves

11 12 13



**FIG.1.8 CROSS SECTION VIEW OF THE FLYWHEEL END OF THE CRANKSHAFT (Sec 16)**

- |                       |                        |
|-----------------------|------------------------|
| 1 Flywheel            | 8 Dowel peg            |
| 2 Gland nut           | 9 'O' ring             |
| 3 Needle bearing      | 10 Crankshaft oil seal |
| 4 Felt ring           | 11 Shims               |
| 5 Retaining ring      | 12 Rear main bearing   |
| 6 Gearbox input shaft | 13 Crankshaft          |
| 7 Lock washer         |                        |

point of the tool used must not be allowed to dig into the crankcase.

3 When the oil seal is removed a number of shims which fit between the flywheel hub and the flange on the front main bearing will be observed. There should be three of them normally. These govern the amount of crankshaft endfloat. Make sure they are kept safely and not damaged.

4 If the crankcase is being split anyway it is simpler to wait until this is done when the oil seal may be easily lifted out.

### 18 Crankshaft and main bearings - removal and renovation

1 In order to remove the crankshaft, camshaft and cam followers (tappets) the two halves of the crankcase will need to be separated. Unless you are quite sure that this is essential do not do it. It is not worth opening the crankcase up just to 'have a look'. Remember also that the main bearing shells are much more expensive than on conventional cars (three of the four are not split) and before you can remove one of them two gears must be removed from the crankshaft. These gears are on very tight and are difficult to draw off.

2 Having decided to split the crankcase, remove the generator pedestal and prop the crankcase on its left side. All pistons and cylinders should already have been removed as should the flywheel. If the flywheel is left on it will add to the difficulty of controlling the weight of the crankshaft when the two halves release it. It will also be much more difficult to remove from the crankshaft afterwards. The connecting rods may be left on as these will be easier to remove after the crankcase is split.

3 The two halves are held together by large and small studs and nuts and two bolts and nuts. Slacken all the smaller nuts followed by the large nuts. Before starting to separate the two halves remember that the crankshaft and camshaft are held between them and you do not want either to fall out haphazardly. So if you keep the crankcase tilted to the left they will both rest in that half.

4 Separate the two halves by tapping lightly at the projecting lugs on the left half with a soft faced mallet or piece of wood. Do not hit anything hard. This progressive gentle tapping at the four corners will gradually increase the gap between the two until the right hand half will be free enough to lift off the studs. If you have a second pair of hands to help so much the better. When the right hand half has moved out a little way there will probably be a light clatter as one or more of the four cam followers in the right hand half fall out. If possible try and get hold of these and arrange them somewhere (in an egg box or numbered row on a shelf) so that they may be put back in the same bores.

5 Put the crankcase half in a safe place where it cannot fall or be damaged.

6 Lift out the camshaft from the other half of the crankcase. The bearing shells may be left in position. If they fall out note where they came from. If being renewed anyway take them out. One half of one shell is flanged to take the camshaft end thrust and the crankcase is suitably machined to accept it.

7 The tappets from the left hand half of the crankcase may now be taken out. Keep them in order like the others so they may be replaced in the same bores.

8 The crankshaft can now be lifted out and should be carefully put somewhere safe. The bearing shell halves for No. 2 main bearing should be removed from their locations in each half of the crankcase. Note that the location of each main bearing is by a dowel peg which locates each bearing shell. These normally remain in the crankcase but if any have come out with the bearings retrieve them now before they get lost.

9 It is possible to examine the connecting rod big end journals after removing the pistons and connecting rods without splitting the crankcase, but only visually. They cannot be measured satisfactorily. Provided there is no good reason to suspect that the big end bearings were seriously worn and that the surface of the journals are bright and smooth with no signs of pitting or scoring then there should be no need to proceed further.

10 The main crankshaft bearing journals may be examined only when the crankcase has been split and the crankshaft taken out. An indication of serious wear in these bearings can be obtained by checking the crankshaft for signs of slackness in the bearings before the crankcase is split. A wooden lever put through one of the cylinder apertures can be used to test for any indications of rocking in the bearings. If there is any then the bearing shells will almost certainly need renewal, even though the crankshaft journals themselves may be serviceable. The journals should be perfectly smooth with a bright mirror finish. They should be measured with a micrometer across the diameter for signs of ovality. If any measurement should differ by more than 0.03 mm (0.0011 inch) from any other the crankshaft should be re-ground. This means taking it to a specialist engineering firm who can grind it to the undersizes permissible and supply the matching new bearing shells. In view of the need to remove the two gears in order to examine No. 3 main bearing journal the condition of the gears should also be checked, in conjunction with their respective mating gears on the camshaft and distributor drive spindle. The bronze worm gear which drives the distributor drive spindle is the most likely to show signs of wear. Any noticeable ridging or 'feathering' and variations in thickness of each spiral tooth indicate wear and renewal is probably justifiable.

11 Three of the four main bearings may be removed as soon as the crankshaft is taken from the crankcase. No. 1 is a circular flanged shell which is drawn off the flywheel end, No. 2 is the split bearing and No. 4 is a narrow circular bearing which can be drawn off the crankshaft pulley end. No. 3 however, is trapped by the helical gear which drives the camshaft. In front of this gear is a spacer and the distributor drive shaft worm gear, an oil thrower disc and Woodruff key.

12 To remove No. 3 main bearing first tap the Woodruff key out of the shaft and keep it safe. Take off the oil thrower disc. The two gears are a tight keyed fit onto the shaft and the only way to get them off is by using a proper sprocket puller which has grips which will fit snugly and completely behind the helical gear so that both the gears and the spacer can be drawn off together. If you have difficulty in fitting the puller in the small gap between the bearing and gear do not try and pull off the gear gripping only against the gear teeth. You will either chip them or break them off. If you are committed to new bearings anyhow, cut the old bearing off to enable you to get the puller properly seated behind the gear.

13 If, when you start putting the pressure on it is obvious that considerable force is going to be needed it is best to clamp the legs of the puller to prevent them spreading and possibly flying off and causing damage to the gear. Some pullers have a clamp incorporated for such a purpose. If you have press facilities available so much the better but on no account should you try to hammer the gears off. It is virtually impossible to do this without damaging the gears.

14 With the two gears removed the bearing can be taken off the shaft.

15 Having taken off the No. 3 bearing it would be unwise not to renew the complete set as a matter of course. If the crankshaft needs re-grinding then the new bearings will need to be of the correct undersize to suit the amount removed during re-grinding. Such bearings will normally be supplied by the firm doing the re-grinding work. If the crankshaft is not being re-ground make sure that the bearings obtained are exactly the same dimensions as those removed. This can be verified by checking the numbers on the bearings which normally include an indication of whether they are standard or undersize. Do not forget that it is always possible that the crankshaft may have been re-ground before.

### 19 Distributor drive shaft - removal

1 The procedure for removing and replacing the distributor drive shaft from an assembled engine is given in Chapter 4. It is mentioned here because it is in order to leave it in position right up until the time when the crankshaft is divided. It should, however, be removed before the crankcase is reassembled.



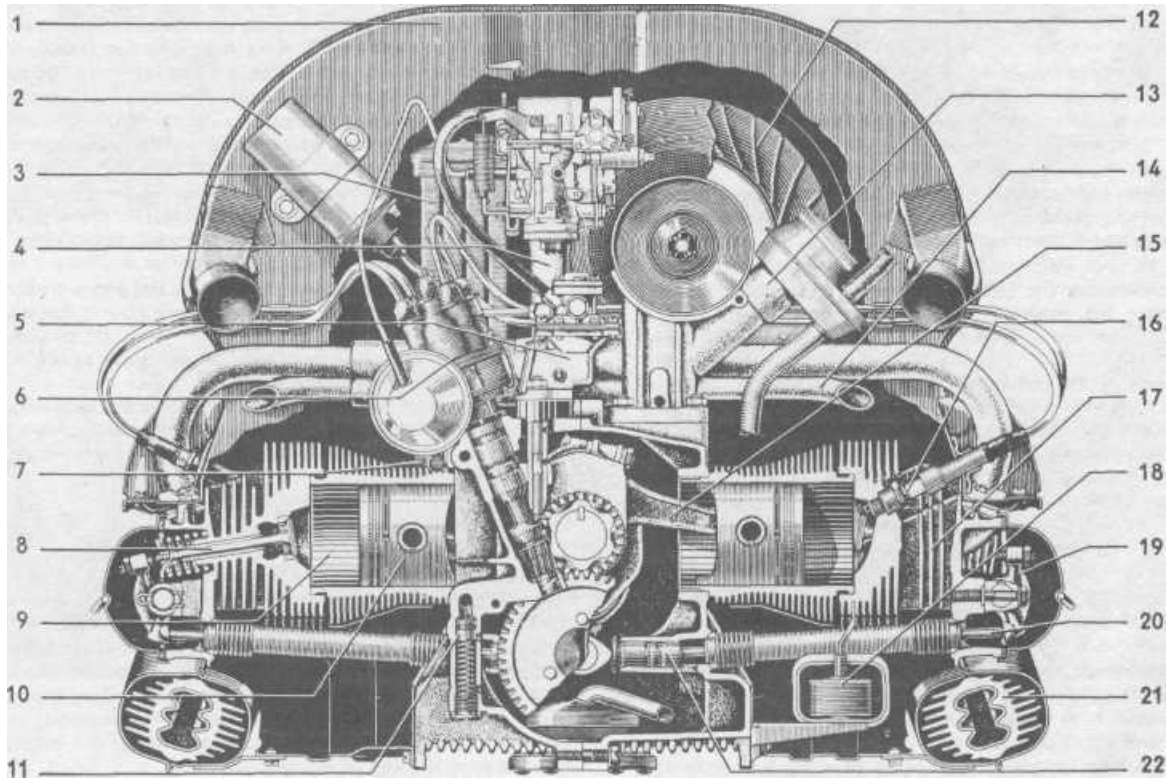
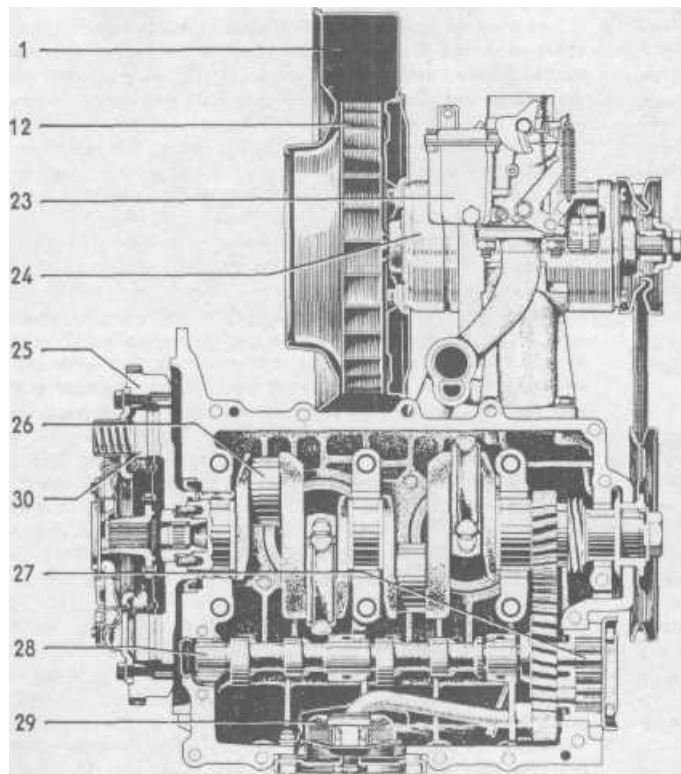


FIG.1.9 ENGINE - CROSS SECTION VIEWS



- 1 Fan housing
- 2 Coil
- 3 Oil cover
- 4 Inlet manifold
- 5 Fuel pump
- 6 Distributor
- 7 Oil pressure switch
- 8 Valve
- 9 Cylinder
- 10 Piston
- 11 Oil pressure relief valve
- 12 Fan
- 13 Oil filler
- 14 Intake manifold preheater pipe
- 15 Connecting rod
- 16 Spark plug
- 17 Cylinder head
- 18 Thermostat
- 19 Rotor arm
- 20 Push rod
- 21 Heat exchange
- 22 Cam follower (tappet)
- 23 Carburettor
- 24 Dynamo
- 25 Flywheel
- 26 Crankshaft
- 27 Oil pump
- 28 Camshaft
- 29 Oil strainer
- 30 Clutch

NOTE: This drawing does not show all the later modifications (e.g. 3 section inlet manifold, one piece fuel pump) but the basic format is the same.



## 20 Crankcase - examination and renovation

The crankcase should be free from cracks or any other form of damage and the two mating edges must be quite free from dents, scratches and burrs which could in any way affect their precise alignment when both are clamped together. The crankshaft bearing locations should also be examined for any signs of damage or distortion. In an engine which has been permitted to run on with worn out main bearings it is possible that the bearing shells themselves will have been 'hammered' by the vibration of the crankshaft into the crankcase. This will mean that new bearings will not be a tight fit in their crankcase locations. In such instances the crankcase must be scrapped. In these circumstances the best action would be to abandon ideas of renovating the engine and obtain a complete replacement. Make sure that the camshaft bearing surfaces are in good condition.

The studs in the crankcase, both for attaching the cylinder heads and for the two halves, must be tight in their threads. Any sign of looseness which may be due to worn threads in the alloy crankcase is repairable. It will mean drilling and fitting a 'Helicoil' insert - which is a new thread in effect. This can be done at the Volkswagen agents for certain and at many other places where aluminium engines and castings are often being repaired. In any case check the economics before buying a lot of other parts.

## 21 Engine reassembly - general

1 As mentioned earlier, the Volkswagen engine is more complex in assembly than a conventional engine with a single cylinder block. It is therefore essential to get everything right first time and this means DO NOT RUSH IT. More than likely you will not have assembled an engine like this before so the order of assembly on other types cannot be relied upon for experience.

2 Before starting work clear the bench and arrange all the components nearby. The assembly surface must be particularly clean and it is a good idea to cover the working surface with sheets of strong paper. Have all the necessary gaskets and seals available together with clean oil in a can or convenient dispenser pack. If you are replacing bearing shells, cam followers and various other parts make sure the old parts are kept away from the assembly area in a carton or something. It is very easy to pick up an old cam follower for instance by mistake. At each stage, get the relevant batch of nuts and bolts ready - having cleaned the grit from them in a paraffin bath. A plentiful supply of clean cloths is the final requirement. Do not forget to clean the tools you will use as well. It is easy to transfer grit from a spanner to the engine with your hands and any small pieces of grit can ruin many hours and pounds worth of work. Again finally, take your time!

## 22 Crankshaft - assembly of gears and main bearings

1 With the crankshaft thoroughly clean and the oilways blown out lubricate No. 3 journal with clean engine oil (photos). No. 3 main bearing is one of the two largest one-piece circular shells. It does not have a flange on it. This bearing goes on to the journal one way only - that is with the small dowel peg hole (which is not central) towards the flywheel end of the crankshaft (photo). Do not get this wrong or assembly will grind to a halt when you try to locate the bearing in the crankcase halves.

2 Next replace the camshaft drive gear. Before putting it on examine the surfaces of the crankshaft and key and the bore of the gear. If there are signs of slight scoring as a result of seizure when the gear was drawn off, clean them up with a very fine file. This will avoid a tendency to bind on replacement. The gear keyway should be lined up with the key in the shaft and the chamfered edge of the gear bore must face the flywheel end - i.e. it goes on first (photo). The gear may be difficult to start on the

shaft so keep it square and make sure that the keyway is precisely lined up (photo). This is most important because if wrong you will have to draw the gear off and start again. It can then be drifted on with firm evenly spaced strikes, around the gear (away from the teeth). Keep it square, particularly at the start, and drive it fully home. The crankshaft should be clamped between padded vice jaws for this operation.

3 Next the spacer ring followed by the spiral distributor drive gear are fitted. They can go on either way round and the gear should be carefully drifted up to the spacer without damaging the spiral teeth (photos). Finally, fit the retaining circlip and make sure it fits snugly in its groove (photo). If it will not go in the groove then one of the gears has not been fully driven onto the crankshaft and this must be rectified.

4 Next fit the small circular bearing over the end journal, once again making sure that the offset dowel peg hole is towards the flywheel end of the crankshaft (photo). Do not confuse the dowel peg hole with the circular groove machined in the outside of this bearing. Lubricate the journal.

5 Next fit the oil thrower disc with the concave face outwards (photo). Fit the Woodruff key (for the crankshaft pulley wheel) into the keyway now as this will prevent the disc from falling off inadvertently, (photo).

## 23 Connecting rods - assembly to crankshaft

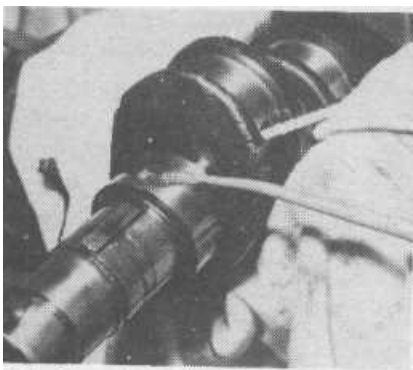
1 If the crankcase has been split the connecting rods (without the pistons) should first be fitted to the crankshaft. Check that the gudgeon pins fit correctly in their respective small end bushes, otherwise difficulty will be encountered in fitting the pistons later. If you are refitting the connecting rods to the crankshaft in the assembled crankcase, note the additional information at the end of this section.

2 Lay the crankshaft down on the bench with the flywheel flange end away from you.

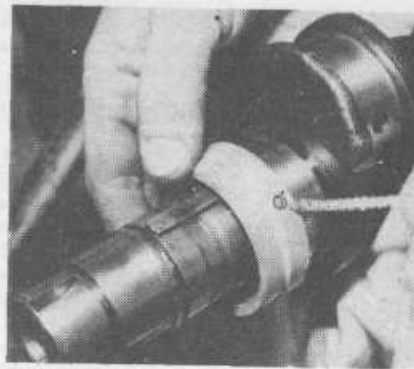
3 Arrange the connecting rods, two on each side of the crankshaft with Nos. 1 and 2 on the right, No. 1 nearest the flywheel end and No. 3 and 4 on the left with No. 3 nearest the flywheel end. Align the numbers on the connecting rod and cap (photo). Note that there is a forge mark (photo) on the connecting rod which often appears on the side opposite to the numbers. This forge mark must always be uppermost when installing the connecting rod. The first crank on the crankshaft, from the flywheel end, is No. 3, left. Pick up the connecting rod and after wiping the bearing surface perfectly clean, fit the bearing shell with the notch engaging in the corresponding notch in the rod. Fit the other half of the shell bearing to the cap in the same fashion (photo). Next, liberally oil the bearing journal with clean oil and assemble the rod to the crankshaft (photo). Match the two numbers on the shoulders and with the rod pointing to the left face them downwards. Replace the cap and nuts finger tight so that the assembly is not loose on the crankshaft (photo).

4 Repeat this for No. 1, right, which is the second crank from the flywheel end followed by No. 4, left and No. 2, right. It is easy to get confused while doing this. If your crankshaft assembly does not look like the one in Fig. 1.10 rotate the crankshaft 180° but keep the connecting rods pointing the same way. Then it should look familiar! Above all, think and do not rush.

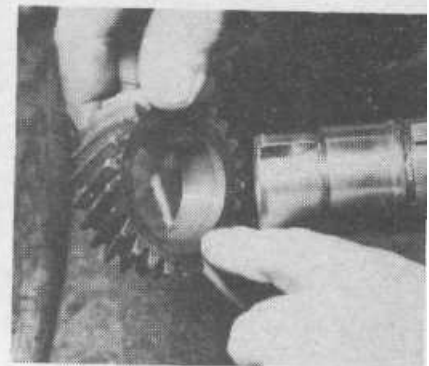
5 Once the rods are correctly fitted to the crankshaft the bolts will need tightening to the correct torque of 3.3 mkg (24 ft lbs). The best way to do this is to mount the crankshaft vertically in the vice, clamping the No. 4 bearing journal firmly between two pieces of wood (photo). All the connecting rod bolts can then be tightened. It is advisable to tap the shoulders of each rod with a hammer to relieve any pre-tension which can be set up between the mating surfaces of the cap and the rod. When the cap bolts are fully tightened the connecting rods should be able to rotate around the journals under their own weight. There should be no tight or 'free' spots anywhere although if you are fitting new



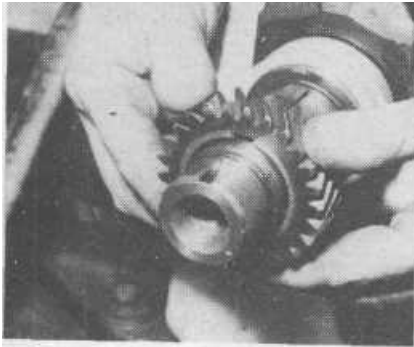
22.1a Clean the crankshaft oilways and lubricate the journal surface.



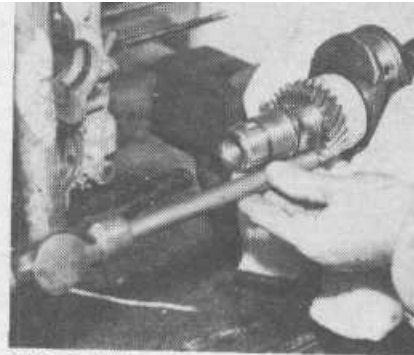
22.1b No. 3. main bearing shell showing the dowel peg hole towards the flywheel



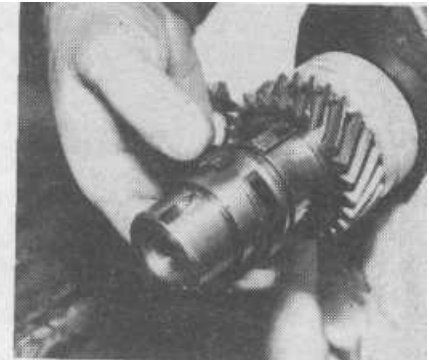
22.2a Replace the camshaft gear with the chamfered edge inwards.



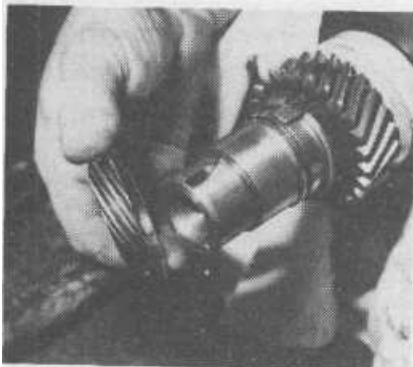
22.2b Line up the gear key way



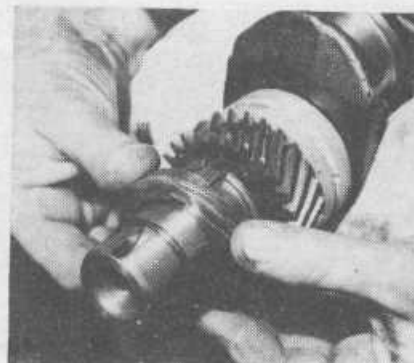
22.2c Drift the gear pulley home



22.3a Replace the spacer collar



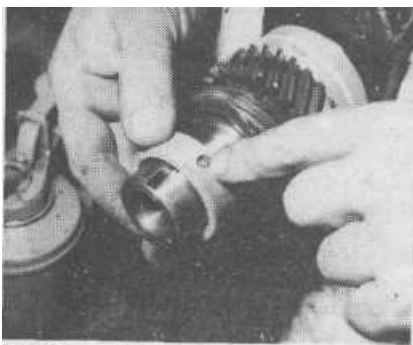
22.3b Replace the distributor drive worm gear



22.3c Line up the key way before driving it home



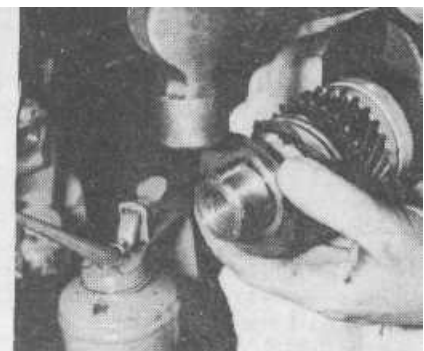
22.3d Fit the circlip



22.4 The end bearing shell locating peg hole must be towards the flywheel end of the crankshaft



22.5a Fit the oil thrower disc



22.5b Tap the Woodruff key into the key way

shells to an un-reground crankshaft this is possible. If very noticeable however, it indicates that the journal is out of round. If rods on a reground crankshaft are slightly tight the engine will need running-in. If very tight then the regrinding tolerances are wrong and it should be returned to the machinists for correction.

6 Place the assembled crankshaft on the bench once more, as before, with each connecting rod facing its proper cylinder position.

7 If you are fitting the connecting rod to an assembled crankcase/crankshaft lay out the rods alongside their respective cylinder positions as already explained and fit the shells into the rods and caps. Turn the crankshaft so that the journal for the rod to be fitted is nearest its crankcase opening. The cap must then be placed on the journal and the rod fitted to it. This is easy if you have four hands and fingers ten inches long! It is helpful to have a piece of bent metal rod which can be put through from the opposite side of the crankcase to hold the cap on the journal whilst the rod and nuts are being fitted. A certain amount of patience is essential as it is more than likely that you will drop a bolt or bearing cap into the crankcase at some stage and have to shake it out. Do not use grease to hold parts together for this assembly. It will probably affect lubrication seriously. The most important thing to ensure is that a bearing shell does not drop out unnoticed and get trapped and damaged while you are fiddling about. So if a shell drops in the crankcase go easy on rotating the crankshaft until you get it out. As soon as the first connecting rod is fitted tighten the bolts to the correct torque and check that it moves freely but without any clearance. You will be refitting new shells to the original journal sizes so if something seems amiss - bearing too tight or too loose - make sure you have bought the correct shells by comparing the numbers and oversize (if any) with the old ones removed.

#### 24 Crankcase, crankshaft, camshaft and cam followers - re-assembly

1 The items in this section heading are grouped together for the ^«< j30<i rare\*?. tfa\ \<iw^ %\ V&Me \o toe a'semfoSeo. togetYier. None may be omitted. (See Fig. 1.10).

2 Both crankcase halves must be perfectly clean, inside and out. All traces of jointing compound must be removed from the mating faces, the roots of the studs, and the chamfers in the stud hole mating faces. Use a solvent such as carbon tetrachloride to remove sealing compound and not a scraper which could damage the aluminium surfaces. The distributor drive gear should have been removed. The oil pump suction pipe must be tightly fitted. If loose it must be peened in position.

3 Place the left hand half of the crankcase on the bench with the flywheel end away from you and leaning over so that it rests on the cylinder head studs.

4 Oil the four cam followers for the left half and place them in their bores. If new followers are being fitted, it is possible that their heads may be slightly thicker than the originals, so compare them (photo). If they are thicker then it is essential to check the clearance between them and the crankcase with the cam lift at its highest point. So having placed the cam followers in position replace the camshaft temporarily, with its shell bearings and revolve it (photos). If any of the cam lobes should jam the followers against the crankcase then clearance will have to be provided by relieving the crankcase by about 1—2 mm behind each cam follower head. This can be done by a small, end face, grindstone in a power drill by a competent handyman. Great precision is not important provided that there is no damage to the actual cam follower bore and the resulting clearance is adequate to permit full unobstructed movement of the cam and follower. Be sure to remove all traces of metal after such work. Repeat this check for the four cam followers in the right hand half of the crankcase.

5 Fit the flanged No. 1 bearing shell at the flywheel end of the crankshaft. Once again make sure that the off-centre locating dowel peg hole goes towards the flywheel end (photo). Look to see that the corresponding dowel pegs in the crankcase will mate

up. The bearing surface of the journal should be well lubricated with clean oil but keep the outside surfaces of the bearing shell clean and dry.

6 Place one half of the split shell in position at No. 2 bearing in the crankcase, engaging the dowel pin in the hole (photo). Lubricate the bearing with clean oil.

7 The crankshaft assembly should now be placed into position in the left hand crankcase half (photo). The three dowel holes in the circular bearings will need lining up so that they will locate snugly and Nos. 3 and 4 connecting rods must pass through their respective apertures. It is a good idea to lift the assembly up by Nos. 1 and 2 connecting rods for this operation. Do not force anything into place. The circular bearings may need rotating a little until you can feel the pegs engage. Ensure the thrower disc locates within the oil thrower recess in the casting. Once all the bearing pegs are located a little pressure will ensure that the assembly and bearings are completely seated. If it is stubborn for any reason lift it out, pause, look, think and have another go.

8 Next fit the camshaft bearing shells into clean locations, engaging the notches in the crankcase (photo). Then oil the bearings in readiness for the camshaft.

9 Turn the crankshaft carefully until two teeth, each marked with a dimple are visible and well clear of the edge of the crankcase. There is a single tooth on the camshaft gear similarly marked which must mesh between them (photo). Engage the teeth and roll the camshaft round, in mesh still, into its bearing location. Then turn the gears again to check that the timing marks are still correctly aligned.

10 Now fit the four tappets (cam followers) into the right hand half of the crankcase and if it seems as though they might fall out when it is lifted and tilted then put a dab of grease behind the lip of each one to help stick it in position.

11 Fit the other half of No. 2 bearing shell into the right half of the crankshaft locating it over its dowel peg correctly.

12 Now thinly coat the two clean, smooth mating surfaces of the crankcase halves with aluminium alloy jointing compound (photo). Use a good quality product such as Volkswagen themselves recommend or 'Hytomac'. Neither is cheap feu\* \<re\ S/OM do not want your crankcase to leak oil when it gets hot. Make %\»« XV\* v\*«> wrtmsa are coaieei comp'iet^y toux thinly anO evenly. Take care to cover round the base of the studs. Do not let any compound get into oilways or other places where it is not wanted and may cause obstruction or binding.

13 The six larger studs may have rubber sealing rings at the roots and these should all be renewed if fitted.

14 Place the right hand half of the crankcase over the studs of the left and carefully slide it down until it just touches the crankshaft bearings (photo).

15 Coat the circular camshaft sealing plug with jointing compound and place it in position in its groove in the left hand half at the flywheel end of the camshaft, with the recess facing inwards.

16 Move the two halves together, tapping lightly with a block of wood if necessary. Use no force - none should be necessary.

17 Now stop and check:

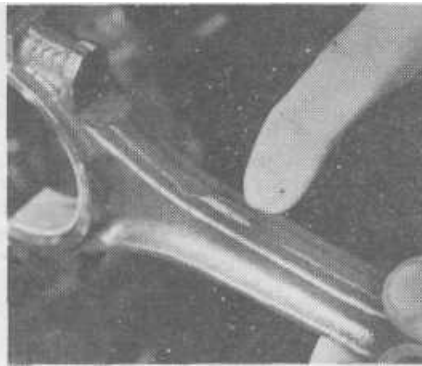
- 1 Are all the connecting rods protruding from their proper holes? Cap nuts tight?
- 2 Are all four bearings, two gears and oil thrower disc fitted to the crankshaft?
- 3 Are all eight cam followers in position?
- 4 You did not forget the camshaft? (It has been known). Did you mesh the timing properly?
- 5 Camshaft sealer plug?

All in order, replace all the nuts on the studs finger tight. Revolve the crankshaft just to make sure that everything moves freely at this stage at least.

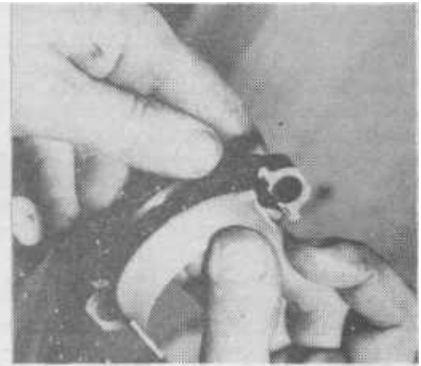
18 It is important to tighten down the stud nuts evenly and in the correct order. Tighten first the six large nuts to a torque of 1.5 mkg (11 ft lbs) only, followed by all the smaller nuts to the same torques. Then tighten the small nut near the lower large stud clamping round No. 1 main bearing to its full torque of 2 mkg (14 ft lbs).



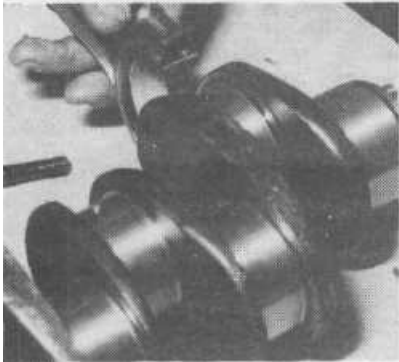
23.3a The connecting rod and cap have matching numbers



23.3b.....and a forge mark which must be uppermost on installation.



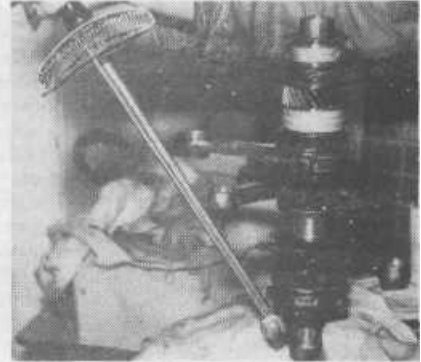
23.3c Fit the bearing shell into the cap.



23.3d Put the rod into position on the journal



23.3e.....and match up the cap.



23.5 Tighten all the cap nuts

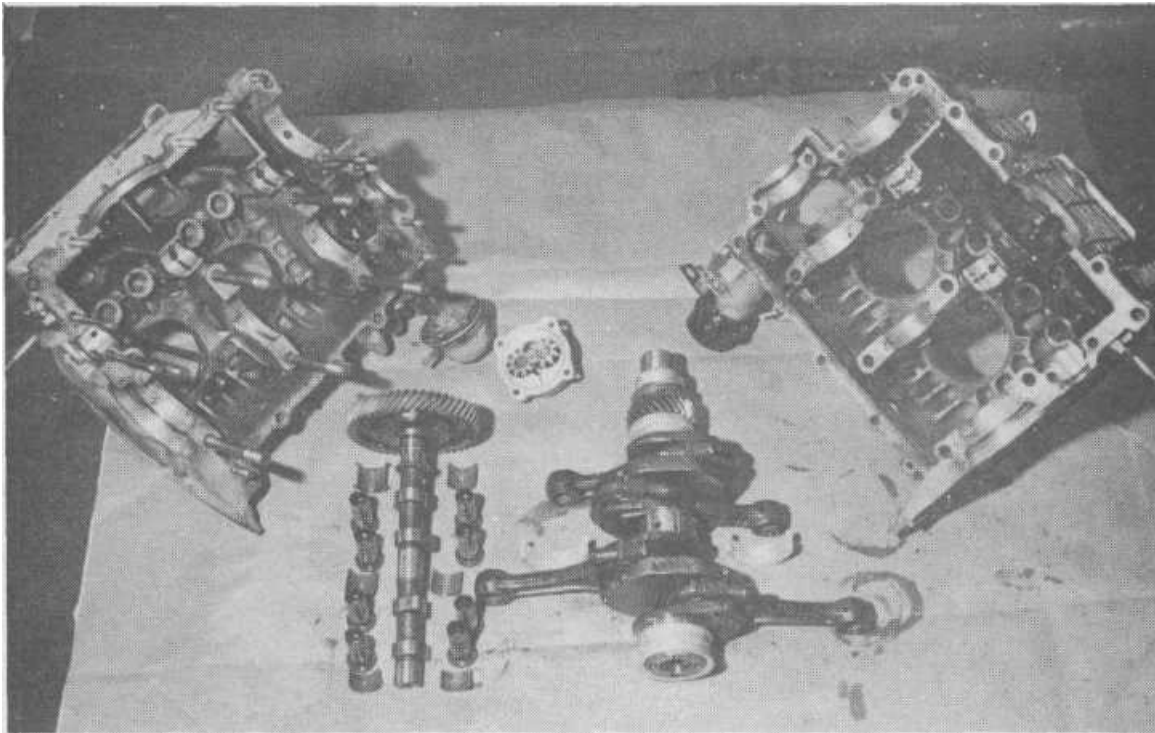


FIG.1.10 CRANKCASE' CRANKSHAFT AND CAMSHAFT READY FOR REASSEMBLY (SEE SECTION 23)

19 Tighten the large nuts progressively to a torque of 20 ft lbs and then to 25 ft lbs. Finally tighten the smaller nuts to 14 ft lbs (photo).

20 Now rotate the crankshaft - it should revolve smoothly without any stiffness. If there is stiffness however, slacken all the crankcase nuts. If it then turns freely something is wrong and you should separate the crankcase again. Then check that all the bearings have been properly located on their dowel pegs and that the split bearings of the camshaft are seated properly. Any pressure spots on bearings will be visible. The cause is normally due to dirt or burrs behind them, particularly on the corners of the bearing bore corners and mating face edges. These can be chamfered lightly if necessary. Whatever happens do not press on until you have found the reason for any tightness. Start again from the beginning if necessary.

## 25 Pistons, rings and connecting rods - reassembly

1 If you are only fitting new rings to existing pistons make sure you have examined the pistons properly as detailed in Section 13 and checked the new ring gaps in the cylinder bores.

2 The new rings should be fitted over the piston crown replacing the bottom ring first. If you do not have a proper ring expander tool spread the ends of the ring so that it goes over the top of the piston. Then carefully ease it down over the other grooves a little at a time. The blade of a feeler gauge or some shim steel will be of great assistance in sliding it over the grooves. Do not bend the ring in any way more than necessary to move it. It breaks easily. The top two rings are different. The lower of the two has a cut-away lower edge and the top ring is chamfered on its outer face. Both rings will be marked 'open' or 'top' which denotes which way up they go. The lower of the two is fitted first. (See Fig. 1.14).

3 When new pistons are supplied for rebored cylinders the rings are already fitted and the gaps should automatically be correct. It does no harm however, to take the top ring off each piston and check it in the bore to make sure.

4 Assuming the small end bushes have been correctly sized for the gudgeon pins remove one circlip from each piston - if not already done - and push out the gudgeon pin until the piston boss is clear to permit the end of the connecting rod to be positioned (photo). If the pins are too tight to push out do not force them. Warm up the pistons in front of the fire or on a radiator or next to an electric light bulb. Do not play over them with a blow lamp or gas torch. They only need warming - not heating.

5 If new pistons are being fitted they can go to any connecting rod and all that matters is that the side of the piston marked on the crown 'flywheel' or with a pointing arrow, goes towards the flywheel end of the engine (photo). Push the gudgeon pin back into place and replace the circlip. Make sure that you use only the circlips supplied with the pistons. Do not use the old circlips just because they are easier to contract. (Volkswagen pistons have wire circlips with long legs (photo). English pistons have spring steel clips with small eyes needing proper circlip pliers to release them).

6 As soon as one piston has been fitted take care because when the crankshaft is rotated the skirt of the piston can foul the crankcase at bottom dead centre unless it is guided into the cylinder aperture. This could break it. Watch too that the piston rings do not get snagged up on anything which could break them.

## 26 Cylinders - replacement

1 Cylinders should normally go back in their original locations unless new pistons are being fitted or they have been rebored, in which case it does not matter.

2 Before fitting the cylinders you may wish to lightly grind them into the seats in the cylinder head. This can be done using

fine carborundum paste. Make sure that all traces of paste are flushed away afterwards. Light grinding in this way helps to ensure a gastight seal but do not overdo it (photo). Make sure that the mating faces at top and bottom of the cylinders are perfectly clean and clear of old gaskets. Select the new thin, cylinder base gaskets from the set and separate them. It is easy for two to stick together. Hang one over each connecting rod now so you do not forget to put them on. Alternatively they may be put in position on the cylinder base - held by a proprietary jointing compound (photo).

3 Cylinders will only go on one way, that is with the narrow fins at the base and the flat fin edges of a pair of cylinders facing each other. This should be remembered for the first cylinder of each pair. You could get it wrong and have to take it off again when the second one is ready to go on!

4 The piston ring gaps should be spaced round the upper 180° of each piston with the gap in the oil control ring facing the top of the engine.

5 The rings must be compressed into the piston grooves in order to get the cylinder over them. The type of compressor used must be such that it will split and come off round the piston because once the cylinder is on it will not be possible to lift it off over the top of the piston. A Jubilee hose clip may be used quite satisfactorily. The cylinder bore is chamfered at the bottom which also facilitates assembly.

6 Fit the clip round the rings and tighten it so that all three are compressed (photo). Take care to see that no ring slips out from under the clip. This can easily happen, particularly when first tightening up the clip screw when a screw type hose clip is used.

7 Tighten the clip until the rings are flush with the piston but do not tighten it so much that the clip grips the piston tightly. Otherwise it will be difficult to slide the clip down the piston when the cylinder barrel takes over.

8 Not forgetting the lower cylinder gasket, place the cylinder over the piston crown narrow end first and with the fin flats facing the adjacent cylinder position and with the four studs aligned in the passages in the fins.

9 Press the base of the cylinder against the piston ring compressor or clip and tap it down with a wooden block or soft hammer (photo). If the clip does not move slacken it a fraction and try again. Do not let the cylinder 'bounce' off the clip when tapping it otherwise you are likely to release an otherwise captive ring. If a ring does escape it will be necessary to start again. If you break a ring you will probably have to buy a set of three for that piston - rarely can you buy a single ring unless you are lucky and a supplier has a part set or is prepared to split a set.

10 Once all rings are inside the cylinder remove the compressor. With the 'Jubilee' clip this means unscrewing it until the end can be drawn out to release it.

11 Next, carefully position the base gasket onto the bottom of the cylinder barrel. Then move the barrel down and locate it into the crankcase. It will not be a tight fit. It is important to make sure that the gasket is not dislodged and trapped incorrectly. If it is, the joint may leak and, worse the cylinder tilt fractionally out of line.

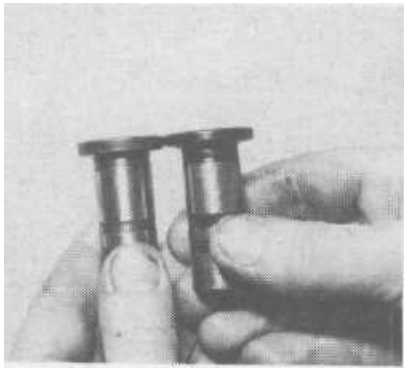
12 It will be necessary to rotate the crankshaft as each cylinder is fitted. When this is done, precautions must be taken to keep the other cylinders in position, otherwise you will have to keep checking the gasket seating. Also guard against the pistons jamming the crankcase at bottom dead centre. The cylinders may be tied down with string to prevent them moving.

## 27 Cylinder heads, valve and springs - reassembly

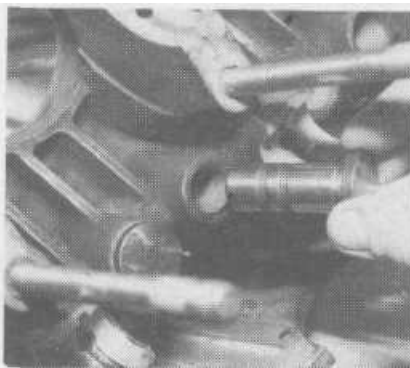
1 The valves removed should be refitted in their original positions unless, of course, new ones are being fitted. (See Fig. 1.11).

2 If possible treat the valve stem with molybdenum disulphide or some other form of anti-scuffing paste to prevent excessive initial wear in the guide.

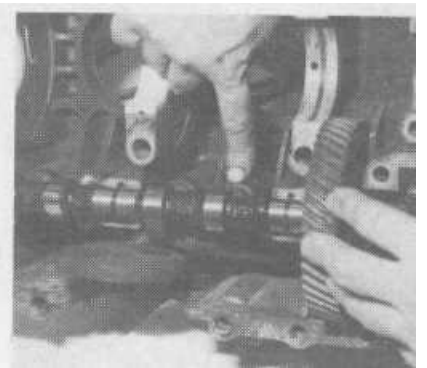
3 Place the valve in the guide (photo). Fit the oil ring round the



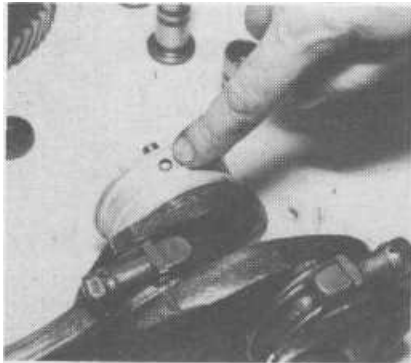
24.4a Compare new tappet flange thicknesses with the old



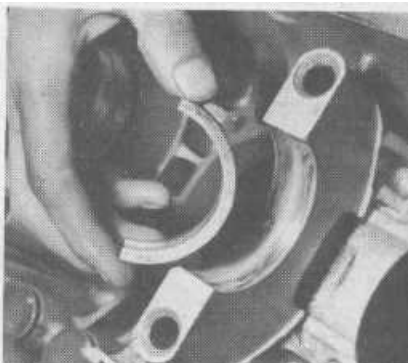
24.4b Put the tappets into the crankcase



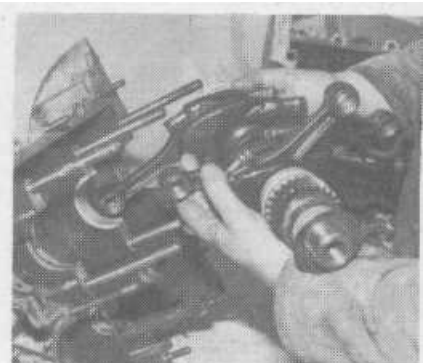
24.4c Check the cam lobe clearances



24.5 No 1 main bearing is flanged. The dowel peg hole goes towards the fly-wheel



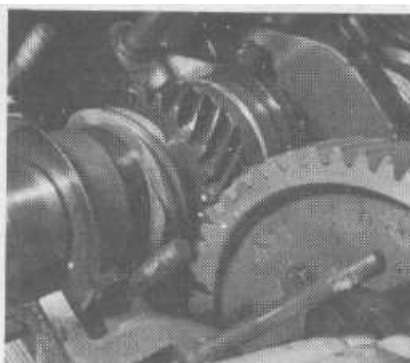
24.6 The only split main bearing is No 2. Fit each half into the crankcase halves.



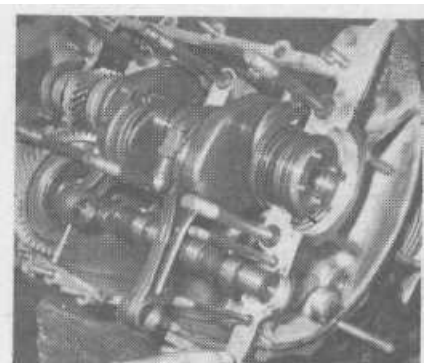
24.7 Place the crankshaft and connecting rod assembly into the left half of the crankcase.



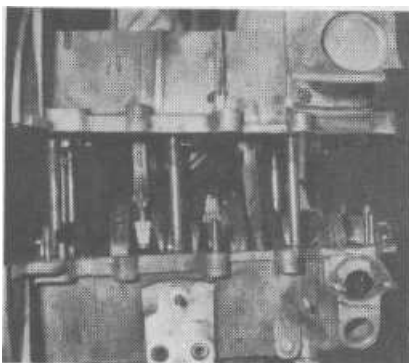
24.8 Fit the 3 crankshaft bearing shells. The rear one is flanged.



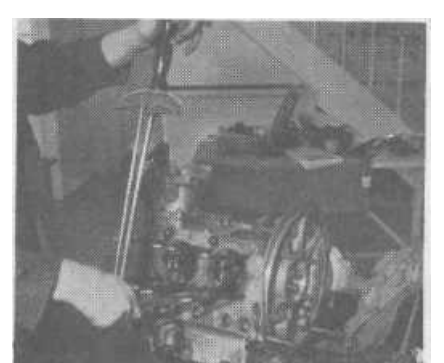
24.9 Mesh the dot on the camshaft gear tooth between the two dots on the crankshaft gear teeth



24.12 Coat the crankcase mating surfaces with jointing compound

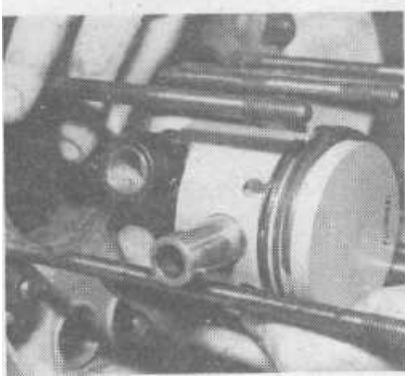


24.14 Fit the two crankcase halves together

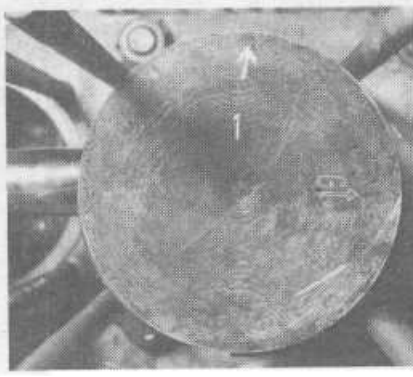


24.19 Tighten the stud nuts in the correct sequence





25.4 Position the piston over the connecting rod small end



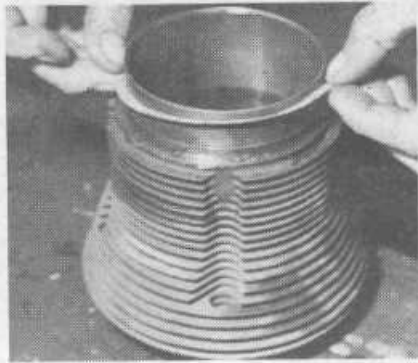
25.5a The makers put an arrow on the piston crown pointing towards the fly-wheel. Note the arrow pointing upwards and the piston No 1 scratched on the crown as well



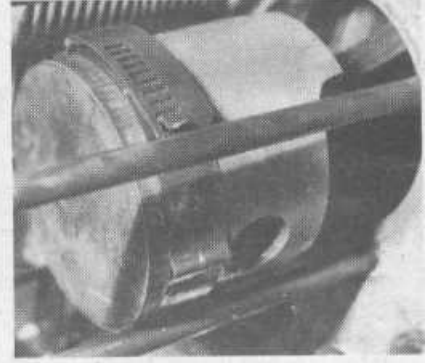
25.5b Fitting a circlip for a VW piston



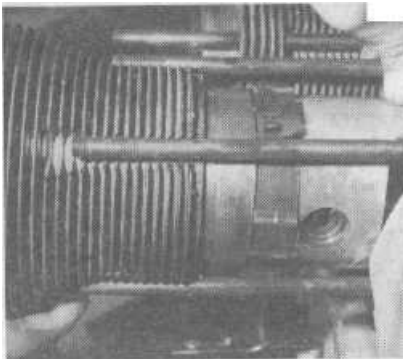
26.2a Grinding the cylinders into the head



26.2b Fitting the cylinder base gasket



26.6 Piston rings clamped



26.9 Fitting the cylinder over the piston

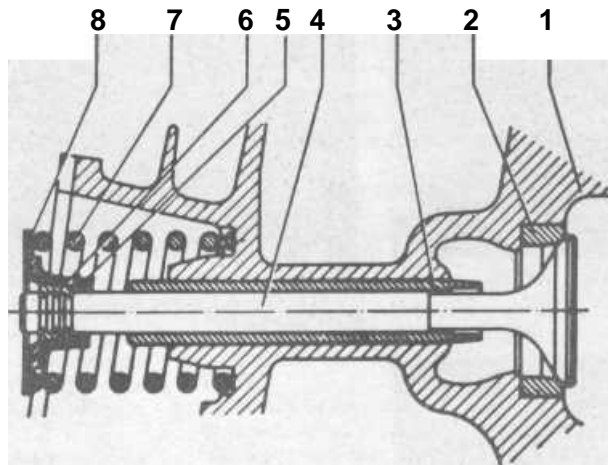


FIG.1.11 VALVE ASSEMBLY-CROSS SECTION (Sec 27)

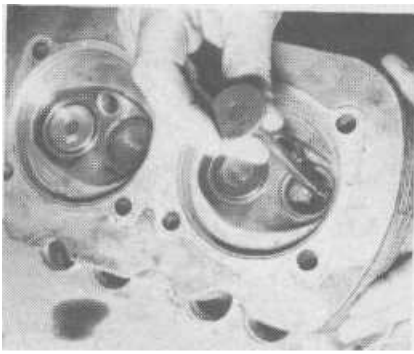
1 Cylinder head  
2 Seat insert

3 Guide  
4 Valve

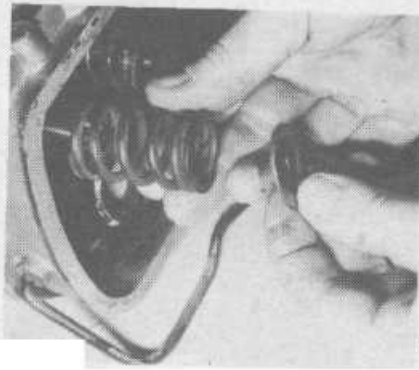
5 Oil seal ring  
6 Split collet

7 Valve spring  
8 Spring retainer

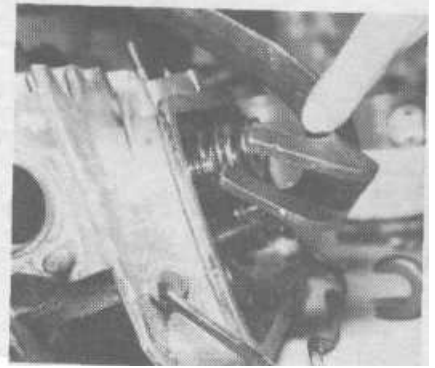




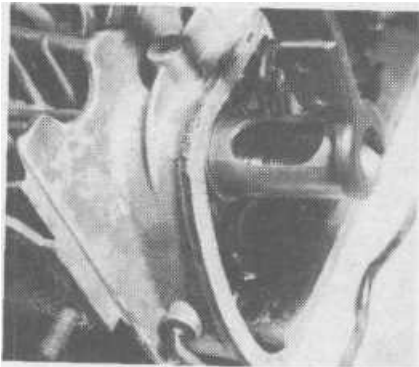
27.3a Inserting an exhaust valve into the head



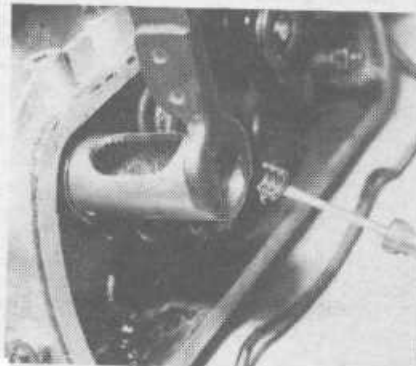
27.3b Fitting the spring and retainer



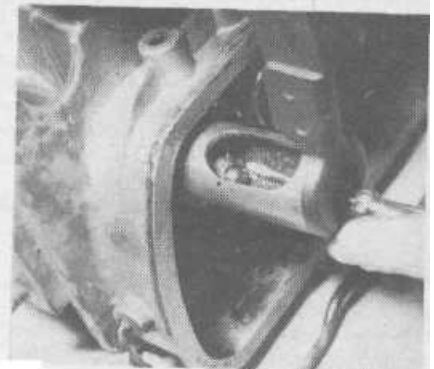
27.4a The spring compressor needs elongated ends .....



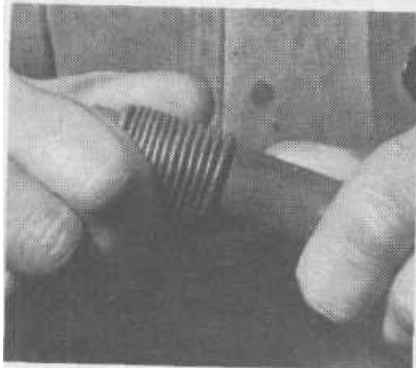
27.4b. . . . or use a piece of tube with a hole in it



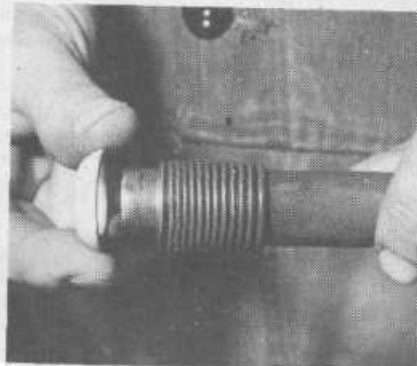
27.6a Use grease to hold the collets on replacement



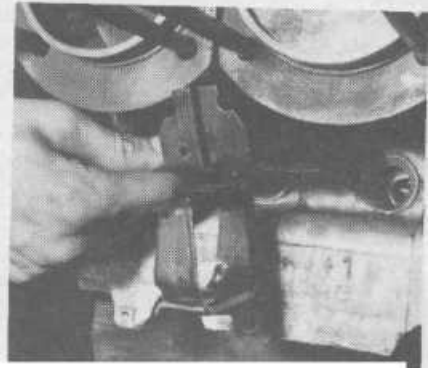
27.6b Collets in position



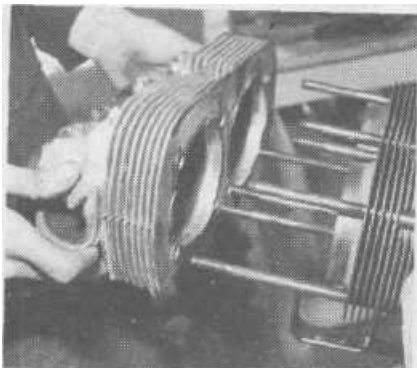
28.1a Stretching the pushrod tubes



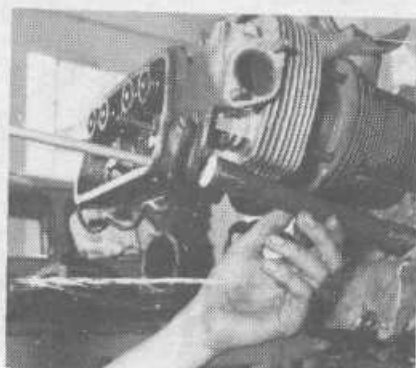
28.1 b Fitting the pushrod tube seals



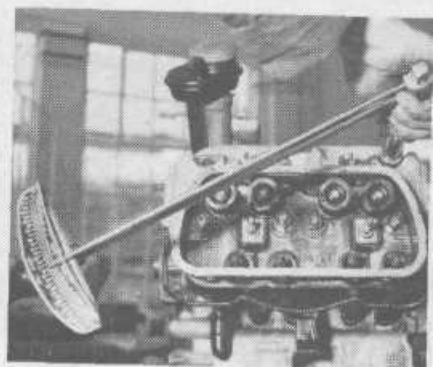
28.2 Fining the lower air deflector plates



28.3a Offer up the cylinder head



28.3b Hold the pushrod tubes with the pushrods to start with



28.7 Tighten the head nuts in the proper sequence

valve stem and then the spring and spring collar. Note that the close coils of the spring go against the head (photo).

4 Next arrange the valve spring compressor with the spacer tube fitted if required and carefully compress the spring (photos). Watch that there is no likelihood of the spring flying out. Often the spring tends to tilt on compression and this can impede the fitting of the split collets. If you can straighten the spring up without risk of releasing it all is well.

5 Compress the spring far enough to expose the grooves into which the split collets locate.

6 It will be necessary to fit the split collets through the slot in the tube if you have used this method. Fingers will be found to be too fat so put a blob of grease on the end of a screwdriver and use this to pick up the collet and put it in position with the narrow end downwards (photos). You may have difficulty with the second half because of the spring not being centrally spaced round the valve stem. This can be overcome by carefully tipping the spring with the compressor or by a little extra compression.

7 When both split collets are properly located in the grooves in the valve stems slowly release the compressor tool making sure that neither of the split collets is pushed out of position. When the spring compressor is fully released the two halves of the split collet should be flush. If not, one is not properly bedded in the grooves of the valve stem.

8 Repeat this procedure for each valve in turn.

## 28 Cylinder heads - replacement

1 First check the pushrod tubes. They have compressible concertina ends and these should be stretched out a little by pulling them so that the distance between the outer ends of the concertina sections is no less than 191 mm (photo). A new sealing ring should be fitted over each end so that the radiused face will go into the head or crankcase as appropriate (photo). When stretching the tubes pull straight so as to avoid any possibility of cracking them. If they are fractured a positive oil leak will result so check their condition carefully (Fig. 1.13).

2 Next fit the sheet steel air deflector plate, of which there is one to each pair of cylinders (photo). It is a spring fit to the two centre studs and to make sure it is tight, the clip flanges may be bent out a little. Note that these deflectors (which guide air into the cooling fins) are on the lower side, i.e. the same side as the pushrod tubes. They follow the contour of the cooling fins when installed so make sure they are the right way round. They cannot be fitted after putting the cylinder heads and tubes in position.

3 One head should not be put on to the eight head studs just far enough to be secure (photo). Then place the four pushrod tubes into position and hold them loosely in position by putting the pushrods back through them (photo).

4 Move the head further into position so that the tube ends locate in their respective seats at both ends. Make sure that the pushrod seals seat firm and square and that the recesses are clean. The seams in the tube should face the cylinders.

5 The cylinder head studs should not be touching any of the cylinder barrel fins so if necessary turn the barrels a little to achieve this. A piece of postcard placed behind each stud will establish the presence of a gap.

6 Replace the stud washers and nuts and tighten them lightly and evenly as far as is possible with a socket and extension using no lever bar.

7 The tightening progression of the nuts is important and is in two stages (photo). First tighten the nuts to 1 mkg (7 ft lbs) in the order shown in Fig. 1.12. Then tighten them to 3.2 mkg (23 lbs ft) in the final diagonal pattern sequence as shown in Fig. 1.12. There is a temptation to overtighten these head nuts. Resist it! Otherwise you will distort the head.

8 Repeat the operation for the second head.

9 1973 models are fitted with smaller diameter head studs which are fixed into the crankcase using 'Helicoil' threaded inserts. The spanner size (15 mm) is not altered but the final tightening torque is increased to 2.5 mkg (18 lbs ft).

## 29 Rocker gear and pushrods - replacement

1 See that the lower ends of the pushrods are properly located in the recesses in the tappets (cam followers).

2 Place a new seal over each rocker assembly mounting stud (photo). Place the rocker shaft support blocks over the studs so that the socketed ends of the rocker arms will line up with the pushrods and the adjusters over the valve stems. The rocker shaft support blocks are chamfered and slotted. They are fitted with the chamfers outwards and slots upwards (photo).

3 Replace the washers and nuts and tighten the two nuts down evenly ensuring that the pushrods are properly engaged in the rocker arms. Tightening torque is 2.5 mkg (18 ft lbs). Slacken all the rocker adjuster screws for later adjustment (photo).

## 30 Crankshaft oil seal - replacement

1 The seal must be replaced (if it has been removed) before the flywheel is fitted. Do not fit it however, until the crankshaft endfloat has been checked as this involves temporary replacement of the flywheel and the movement of shims.

2 Before fitting the seal, place the necessary circular shims over the crankshaft flange and make sure they are perfectly clean and lightly oiled (photo).

3 Coat the outer metal edge of the new oil seal with jointing compound and place it squarely in position into the crankcase with the inner lip of the seal facing inwards (photo). It may then be tapped squarely home using a suitable mallet or piece of wood.

## 31 Flywheel - replacement

1 If you have taken the flywheel off you will presumably have the same equipment still available for replacing it. You will need it.

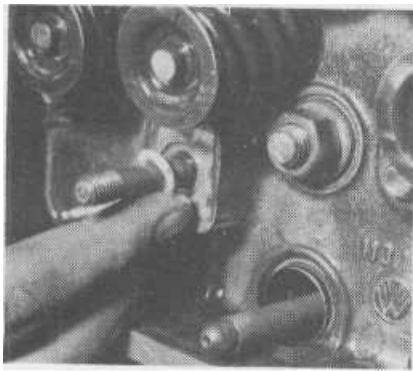
2 If you have overhauled the complete engine it will be advisable to check the crankshaft endfloat. This is governed by the gap between the inner face of the flywheel boss and the flange of the rear main bearing shell. Shims are introduced to reduce the gap and these shims need to be fitted before the oil seal. Although it is possible for them to be pushed in past the oil seal it is very difficult to get them out again without buckling or kinking them. If the main bearing shell has been renewed it is most likely that the shims originally fitted will be correct as the main wear takes place on the bearing shell flange. Three shims are always used to make up the required total thickness and they come in six thicknesses (0.24 mm, 0.30 mm, 0.32 mm, 0.34 mm, 0.36 mm, 0.38 mm). Fit two shims to start with, when the thickness of the third may then be calculated.

3 The four dowel pegs should all be placed in the crankshaft flange after having been checked for fitting in both the flange and the flywheel (photo). If any of these should be slack there is considerable risk of the flywheel working loose, despite the tightness of the nut, and this could be disastrous.

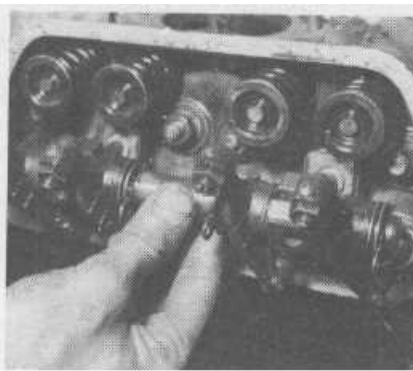
4 In the flywheel flange recess there will be the fine 'O' ring seal. Renew this before placing the flywheel in position and before measuring any crankshaft end float.

5 Grip the flywheel firmly and, with the marks lined up, locate it over the dowel pegs (photo). It is most important for the flywheel to be kept square. If it proves a bit of a strain and a fiddle to get in position find a piece of wood of a thickness suitable to support it at the right height. Once the flywheel is positively located on the pegs replace the centre bolt and washer and take it up as far as it will go finger tight. Then very carefully tighten the bolt to draw the flywheel on, at the same time keeping it perfectly square by tapping the rim as necessary with a soft faced mallet. If the bolt is tightened with the flywheel out of square the dowel pegs and holes will be damaged.

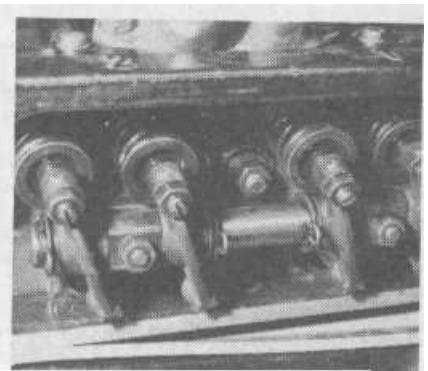
6 It will be necessary to tighten the centre bolt to at least 75 ft lbs in order that the crankshaft endfloat may be accurately read.



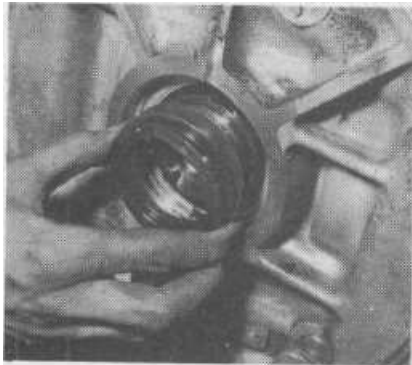
29.2a Fit new rocker shaft mounting stud seals



29.2b Replace the rocker shaft assembly...



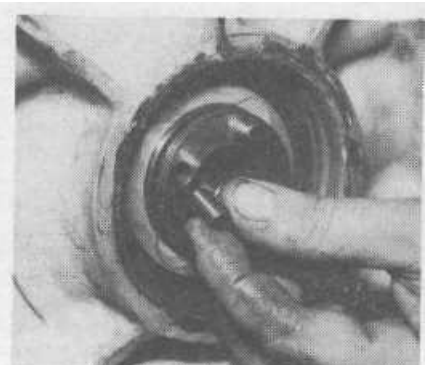
29.3. . . making sure the pushrods are seated correctly



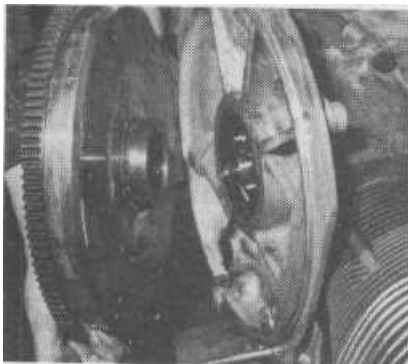
30.2 Crankshaft end float shims being assembled



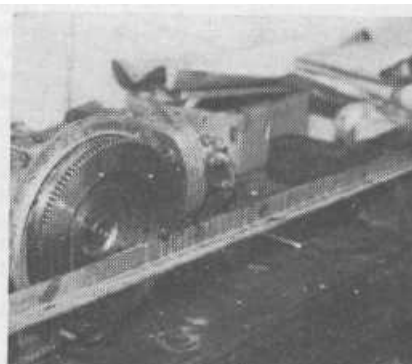
30.3 Replacing the oil seal



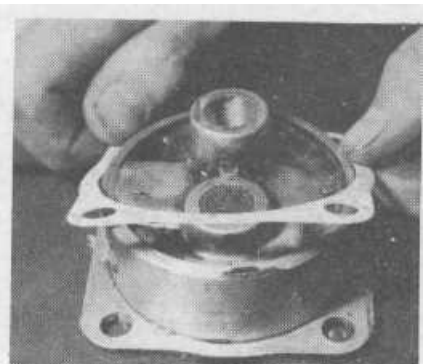
31.3 Flywheel/crankshaft dowel pegs in position



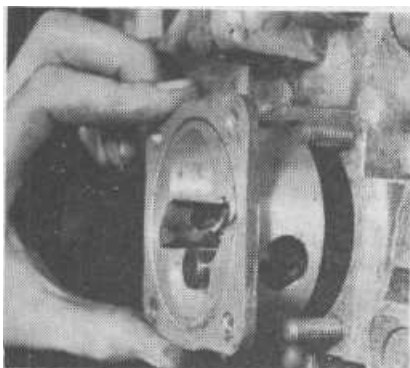
31.5 Offer up the flywheel



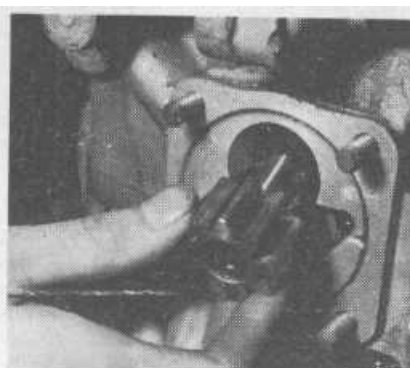
31.8 A piece of flat bar or angle on 2 clutch securing screws will hold the flywheel pin whilst the nut is tightened



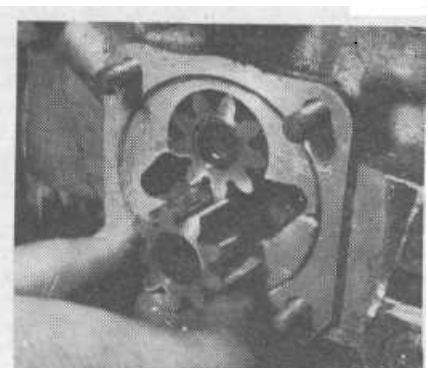
32.2a Fit a new oil pump body gasket .



32.2b .... and replace the body in the crankcase



32.5a Replace the driving gear.....



32.5b. . . and driven gear

To do this a dial gauge micrometer is used against the face of the flywheel. The crankshaft is then moved in and out and the float measured. The thickness of the third shim is the measured float less 0.10 mm. Any three shims will do of course provided they add up in total thickness to the sum of the two in position and the calculated third.

7 Once the correct shims have been selected the flywheel should be removed and the three shims put in position and the oil seal fitted as described in Section 30- The flywheel is then replaced in the same fashion.

8 Final tightening of the centre bolt involves a torque of 253 ft lbs (35 mkg) and the locking of the flywheel for this purpose should be arranged in the same way as for removal (photo). It is important to get this torque as accurate as possible because the flywheel may vibrate loose if it is insufficient. Too much, on the other hand, could cause unwanted stresses.

9 It should also be remembered that the flywheel bolt has a built-in roller bearing which supports the transmission input shaft. This bearing should be in good condition and not over-greased.

### 32 Oil pump - replacement

1 Make sure that the mating faces of the crankcase and pump body are perfectly clean and unmarked.

2 Using a new gasket fit the pump body over the studs so that the fixed spindle is towards the bottom of the crankcase (photos).

3 Carefully tap the body fully home over the studs, taking care that the gasket does not get trapped incorrectly.

4 When the body is fully home tighten the two crankcase stud nuts, above and below, to the correct torque.

5 Next fit the two gears, turning the driving spindle so that the tongue engages in the slot in the end of the camshaft (photos). With both gears fully home the engine should now be turned through at least two complete revolutions. This ensures that the pump body is correctly centred by the revolving gears. The body should not be disturbed again after this has been done. Fit a new cover plate gasket followed by the cover plate (photo). Replace the four nuts. Whilst tightening up the nuts to the recommended torque of 14 ft lbs it is worthwhile rotating the crankshaft once or twice more in case the pump body should inadvertently have moved during tightening.

### 33 Oil cooler - replacement

1 On the earlier models where the cooler bolts direct to the crankcase first make sure that new seals of the correct type are used. They are thick enough to prevent the surfaces of the cooler and crankcase touching when first positioned.

2 On later types, using new special seals for the oil ways, fit the cooler over the studs on the mounting adaptor. Fit the small sealer plate with the foam rubber strip over the same studs before fitting and tightening the nuts (photos).

3 Put two new special seals for the oil ways between the adaptor and the crankcase and fit the whole assembly to the crankcase. Tighten the nuts firmly but take care not to shear the studs (photos).

### 34 Valve to rocker clearances - adjustment

1 Valve clearances are important. If they should be too great the valves will not open as fully as they should. They will also open late and close early. This will affect engine performance. Similarly, if the clearances are too small the valves may not close completely, which will result in lack of compression and power. It will cause damage to valves and seatings.

2 The valve clearances should be set for each cylinder when the piston is at the top of its firing stroke. With the engine in the vehicle this may be first found on No. 1 cylinder (right, front

looking towards front of car) by removing the distributor cap and turning the engine so that the notch on the crankshaft pulley lines up with the centre of the crankcase and the rotor arm points to the notch in the edge of the distributor body.

3 With the engine out of the car and distributor not yet installed the easiest method is to turn the crankshaft pulley wheel clockwise up to the mark and at the same time keep a finger over No. 1 cylinder plug hole to check that there is compression. This indicates that you are on the firing stroke.

4 Both valves on No. 1 cylinder may then be adjusted. First slacken the locknut on each rocker arm adjusting screw. Then select a feeler blade of thickness 0.006 inch/0.15 mm and place it between the adjuster and the end of the valve stem and turn the adjusting screw until a light drag can be felt when the blade is moved (photo). Tighten the locknut, holding the adjuster simultaneously with a screwdriver (photo). Check the gap once again.

5 Continue with the subsequent cylinders; the order is 2, 3, 4 and the crankshaft pulley wheel should be rotated  $\frac{1}{2}$  turn (180°) anti-clockwise. The distributor rotor arm will turn  $\frac{1}{2}$  turn (90°). The valve clearances for No. 2 cylinder may then be set. Continue the same way for cylinders 3 and 4 in that order.

6 Do not forget that the valve clearance settings have been increased. If there is a sticker on the fan housing saying the clearance is .004 inches ignore it. Put your own sticker on instead.

### 35 Engine - reassembly of ancillaries

Apart from the air cleaner all the component parts of the engine can, and should be, assembled to it before replacing the engine in the vehicle. The assembly of the 'tin-ware' requires care and patience and it is important that the retaining screws are complete and secure. Replace the spark plugs and HT leads and set the ignition timing as near as possible at this stage. Remember also that on the later models with the three piece induction manifold that the centre section cannot be fitted after the generator/fan assembly is in position, just the same as for the earlier single piece manifold. The two outer sections of the manifold should be assembled loosely after that. Do not tighten the securing nuts at this stage.

Assemble the heat exchangers and exhaust system to the engine, to each other and to the inlet manifold with all clips, gasket screws and sleeves loosely put together. Do not fit any one unit and tighten up the screws or nuts before assembling the other parts which join it. Then tighten up in the following sequence:-

Inlet manifold flange to cylinder heads nuts.

Heat exchanger flange to cylinder head nuts.

Exhaust manifold flange to cylinder head nuts.

Exhaust manifold to heat exchanger pipe clamp bolts and nuts.

Inlet manifold pre-heater pipe flange to exhaust manifold flange screws.

Inlet manifold centre section, to crankcase clamp nut (later models).

Heat exchanger connecting sleeve screws.

Inlet manifold flexible connector clips (later models).

Fit the fuel pump before the carburettor.

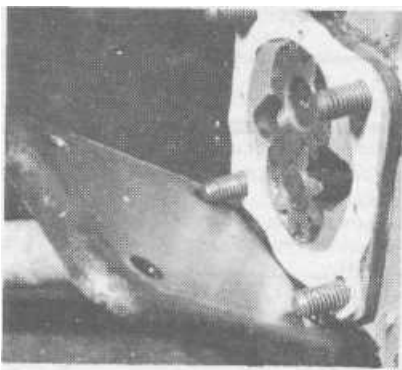
Attach the thermostat bellows to the pull rod and adjust the setting before fitting the lower right hand duct plate.

### 36 Engine - replacement and starting up

1 If the starter motor has been removed refit it to the transmission and connect the leads before replacing the engine. It is much easier. Put the right hand top mounting bolt in position into the casing also and check that the nut runs easily on it.

2 Make sure the clutch assembly is fitted and the friction disc has been properly centralised.

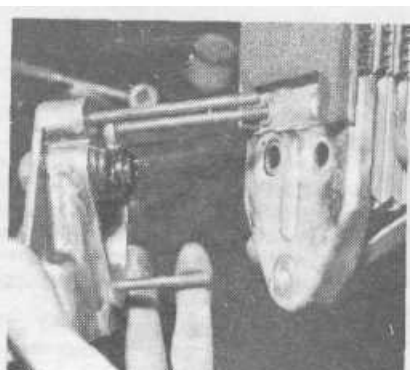
3 Put the accelerator guide tube in position through the fan



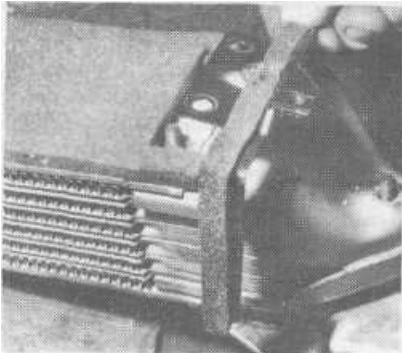
32.5c The oil pump complete goes on last



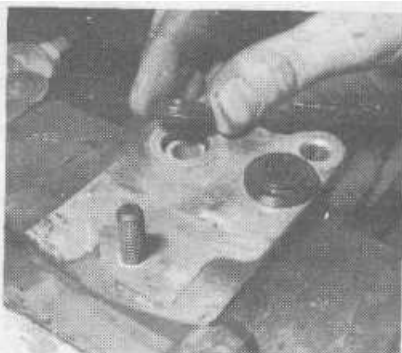
33.2a Oil cooler seals on the mounting bracket



33.2b Fitting the oil cooler to the bracket



33.2c The small sealer plate goes on the bracket studs



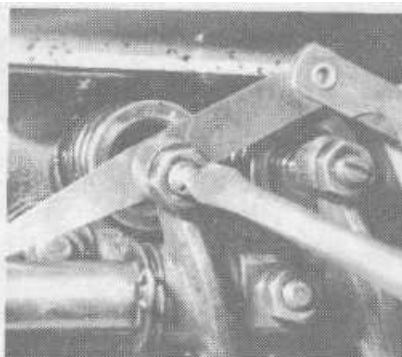
33.3a Oil cooler seals on the crankcase



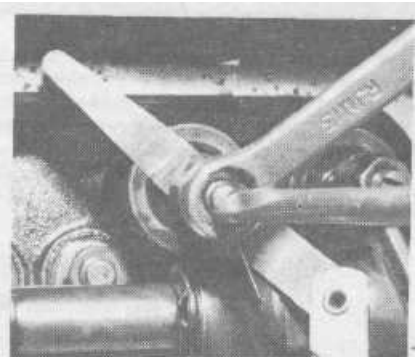
33.3b Fitting the cooler assembly to the crankcase



33.3c Tighten the oil cooler mounting screws



34.4a Adjust valve clearance with the screw....



34.4b Tighten the locknut

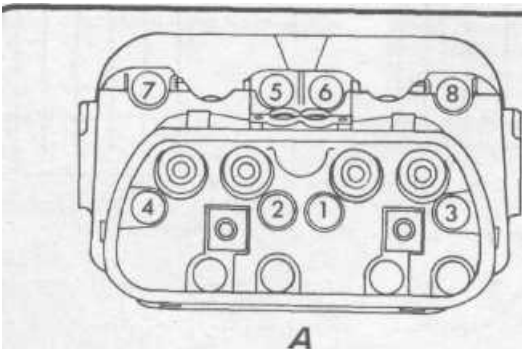
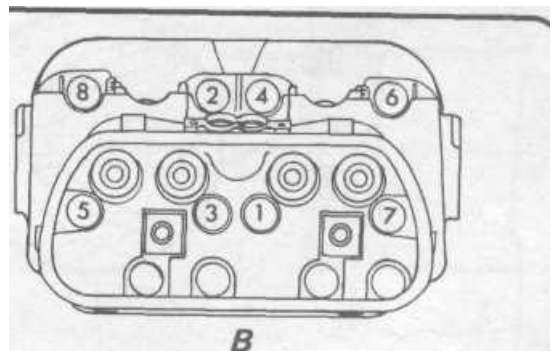


FIG.1.12 CYLINDER HEAD NUTS. TIGHTENING SEQUENCE (Sec 28)



A up to 7lbs/ft (1 mkg)  
B up to 23 lbs/ft (3.2 kgm)



housing. Also ensure that the accelerator cable is in a position where it will not get trapped or kinked.

4 With the rear of the vehicle raised move the engine into position underneath so that it can be lifted. Ideally it will be raised on a trolley jack.

5 There is little fore and aft clearance inside the engine compartment. For this reason the engine must not be tilted otherwise the gearbox input shaft may get snagged up with the clutch cover.

6 As soon as the input shaft is lined up with the clutch centre, feed the accelerator cable through the guide tube in the fan housing.

7 Push the engine forward so that the lower mounting studs engage in the holes and the crankcase moves right up to the transmission casing. It may be necessary to waggle the engine about a little to achieve this. It is important to note that any attempt to draw the engine into position with the mounting bolts when there is a considerable gap may crack the crankcase or transmission casing.

8 The upper right hand mounting bolt should engage its head into the transmission casing and the nut can be fitted from inside the engine compartment. The two lower nuts and the upper left hand bolt are fitted from underneath the car. The bolt goes into a captive nut or threaded lug on the crankcase.

9 When the engine is in position reconnect or adjust the following from underneath:—

- Fuel line
- Heater hoses
- Heater flap control wires
- Starter cables
- Adjust the clutch pedal free play

The following items must be connected from above.

- Accelerator cable (see adjustment details in Chapter 3)
- Generator leads (3) brown at the fan end, red on the left D+ terminal near the pulley, and green on the D-terminal
- Automatic choke lead (black)
- Solenoid cut off valve on carburettor (black)
- Coil - black to 15 - green from distributor to terminal 13
- HT leads (See Chapter 4).
- Oil pressure switch (blue/green)

Fuel pipes

All hoses

Replace distributor and set ignition timing (see Chapter 4).

Replace the rear cover plate, ensuring that all screws are correctly fitted and the small insulator plates secured round the inlet manifold pre-heater pipes.

Remove the dipstick (to prevent blow back up the filler pipe) and fill the engine to the top mark on the dipstick.

Reconnect the battery.

10 If the engine does not fire and run fairly quickly it is likely to get flooded due to the operation of the automatic choke. In such cases press the accelerator to the floor and hold it there until the engine fires. If it still fails to start go through the ignition and fuel system fault diagnosis as outlined in the respective chapters.

11 Once the engine starts see that the oil warning light goes out and then go immediately to the engine compartment to see if there is anything going on which should not. Let the engine run until normal working temperature is reached and then adjust the carburettor as necessary. Then stop the engine, let it stand for a minute or so and recheck the oil level.

12 Road test, if the performance is not satisfactory make small alterations to the distributor timing setting, testing on the road after each adjustment.

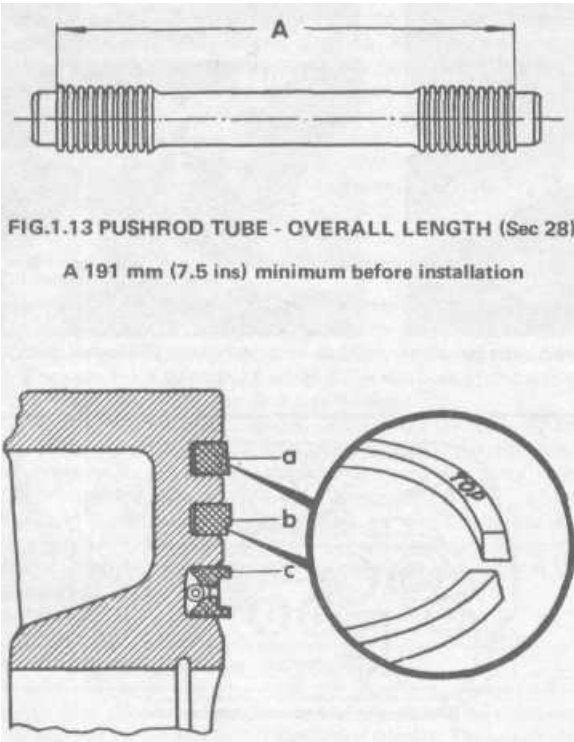


FIG.1.14 PISTON RINGS (Sec 26)

- (a) Top compression ring
- (b) Lower compression ring with stepped lower edge
- (c) Oil control ring

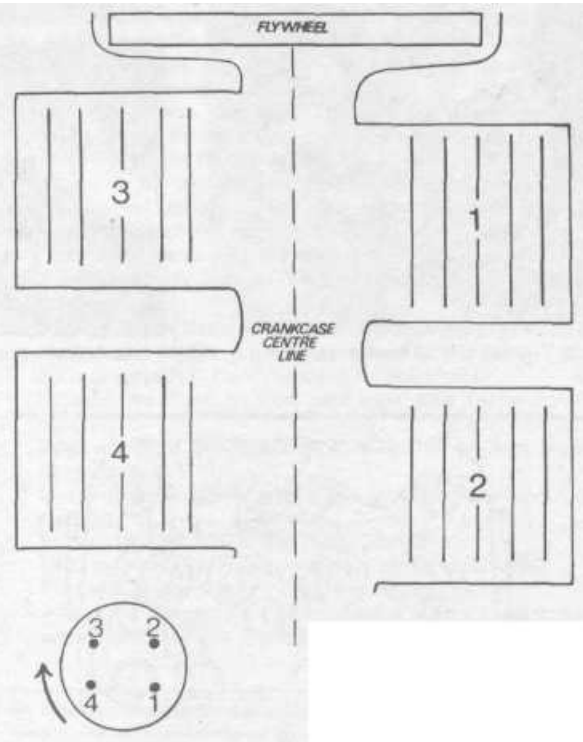


FIG 1.15 PLAN VIEW OF PISTONS SHOWING FIRING ORDER (Sec. 34)

## 37 Fault finding

When investigating starting and uneven running faults do not be tempted into snap diagnosis. Start from the beginning of the check procedure and follow it through. It will take less time in the long run. Poor performance from an engine in terms of power and economy is not normally diagnosed quickly. In any event the ignition and fuel systems must be checked first before assuming any further investigation needs to be made.

Symptom	Reason/s	Remedy
Engine will not turn over when starter switch is operated	Flat battery Bad battery connections Bad connections at solenoid switch and/or starter motor Starter motor jammed  Defective solenoid Starter motor defective	Check that battery is fully charged and that all connections are clean and tight.  Rock car back and forth with a gear engaged. If ineffective remove starter. Remove starter and check solenoid. Remove starter and overhaul.
Engine turns over normally but fails to fire and run	No spark at plugs  No fuel reaching engine  Too much fuel reaching the engine (flooding)	Check ignition system according to procedures given in Chapter 4. Check fuel system according to procedures given in Chapter 3. Slowly depress accelerator pedal to floor and keep it there while operating starter motor until engine fires. Check fuel system if necessary as described in Chapter 3.
Engine starts but runs unevenly and misfires	Ignition and/or fuel system faults  Incorrect valve clearances Burnt out valves	Check the ignition and fuel systems as though the engine had failed to start. Check and reset clearances. Remove cylinder heads and examine and overhaul as necessary.
Lack of power	Ignition and/or fuel system faults  Incorrect valve clearances Burnt out valves  Worn out piston or cylinder bores	Check the ignition and fuel systems for correct ignition timing and carburettor settings. Check and reset the clearances. Remove cylinder heads and examine and overhaul as necessary. Remove cylinder heads and examine pistons and cylinder bores. Overhaul as necessary.
Excessive oil consumption	Oil leaks from crankshaft oil seal, rocker cover gasket, oil pump, drain plug gasket, sump plug washer, oil cooler Worn piston rings or cylinder bores resulting in oil being burnt by engine. Smoky exhaust is an indication Worn valve guides and/or defective valve stem seals	Identify source of leak and repair as appropriate.  Fit new rings - or rebore cylinders and fit new pistons, depending on degree of wear. Remove cylinder heads and recondition valve stem bores and valves and seals as necessary.
Excessive mechanical noise from engine	Wrong valve to rocker clearances Worn crankshaft bearings Worn cylinders (piston slap)	Adjust valve clearances. Inspect and overhaul where necessary.
Unusual vibration	Misfiring on one or more cylinders Loose mounting bolts	Check ignition system. Check tightness of bolts and condition of flexible mountings.



# Chapter 2 Cooling, heating and exhaust systems

For extra information, see Supplement at end of manual

## Contents

General description	1	Thermostat and controls - removal, replacement and adjust- ment . . . . .	7
Removal of components - general	2	Heater controls - checking and setting . . . . .	8
Fan belt - adjustment, removal and replacement	3	Exhaust system - removal, inspection and replacement . . . . .	9
Fan and dynamo - removal and replacement . . . . .	4	Supplementary heaters . . . . .	10
Fan housing - removal and replacement	5	Faultfinding . . . . .	11
Heat exchangers - removal and replacement . . . . .	6		

## Specifications

Air volume . . . . .	575 litres/21 cub ft per sec. at 4000 rpm
Thermostat opens at	65 - 70° C / 149 - 158° F
Fan to cover plate clearance	1.5 mm / 0.060 in

## TORQUE WRENCH SETTINGS

Fan nut	lbft	m kg
Drive pulley nut	43	6.0
	43	6.0

### 1 General description

One of the most famous and well known features of the Volkswagen engine throughout its life has been the fact that it is air cooled. The advantages are obvious - none of the problems and cost of maintaining a water cooling system with the attendant problems of extreme temperatures. There are certain disadvantages of an air cooled system however - there is greater engine noise, more engine power used to drive the cooling fan and a less precise control of engine temperatures. Air cooled engines are not at their best in dense traffic in hot weather. Great care must also be taken to ensure that the lubrication system is not neglected as the engine oil plays a more significant part in engine cooling.

The Volkswagen system is neat and simple. A multi-bladed turbo fan is mounted on a shaft which is simply an extension of the generator armature shaft. It rotates in a sheet steel, semi-circular housing, drawing in air through the fan centre and directing it down to each pair of finned cylinders. The cylinders are shrouded above with carefully designed sheet steel covers. Below each pair of cylinders a contoured deflection plate is mounted centrally. Thus the air is directed over the full surface area of the cylinder cooling fins.

In order to shorten the warming up time a thermostat is mounted below the right hand pair of cylinders. This is a conventional bellows type and it operates a restriction on the through flow of air when the engine is cold. Flaps in the fan housing are opened by the thermostat when the engine warms up, so allowing the full air flow to pass round the cylinders.

The car heating system is linked with the cooling system. In addition to the cooling air circuit there are two heat exchangers mounted one below each pair of cylinders. In effect these heat exchangers consist of a finned section of exhaust pipe from the front cylinder at each side which is encased in a sheet steel 'tank'. A smaller 'tank' also encases the short piece of exhaust pipe from the rear cylinders. The two 'tanks' are connected together.

Air from the fan housing passes through flexible hoses to the top of the small heat exchangers and then through the larger ones. Hot air then passes from the heat exchangers along lagged ducts under the floor to the front of the vehicle. The air is ducted out through floor vents or onto the windscreen. At the exit of each heat exchanger a flap controlled from the instrument panel regulates the output of hot air.

The heat exchangers are made from special corrosion and rust resistant metals so that under normal circumstances their life is indefinite. The exhaust silencer box also is of above average durability.

Models which are exported to arctic climates cannot generate enough heat from this system to be effective so petrol burning heater units are fitted to supplement the heating system.

These units are complex and potentially dangerous if tampered with by inexperienced people. For this reason this Chapter includes only a descriptive drawing (Fig.2.7), to illustrate its function, together with a wiring diagram (Fig. 2.8). Where fitted it is mounted on the left side of the engine compartment.

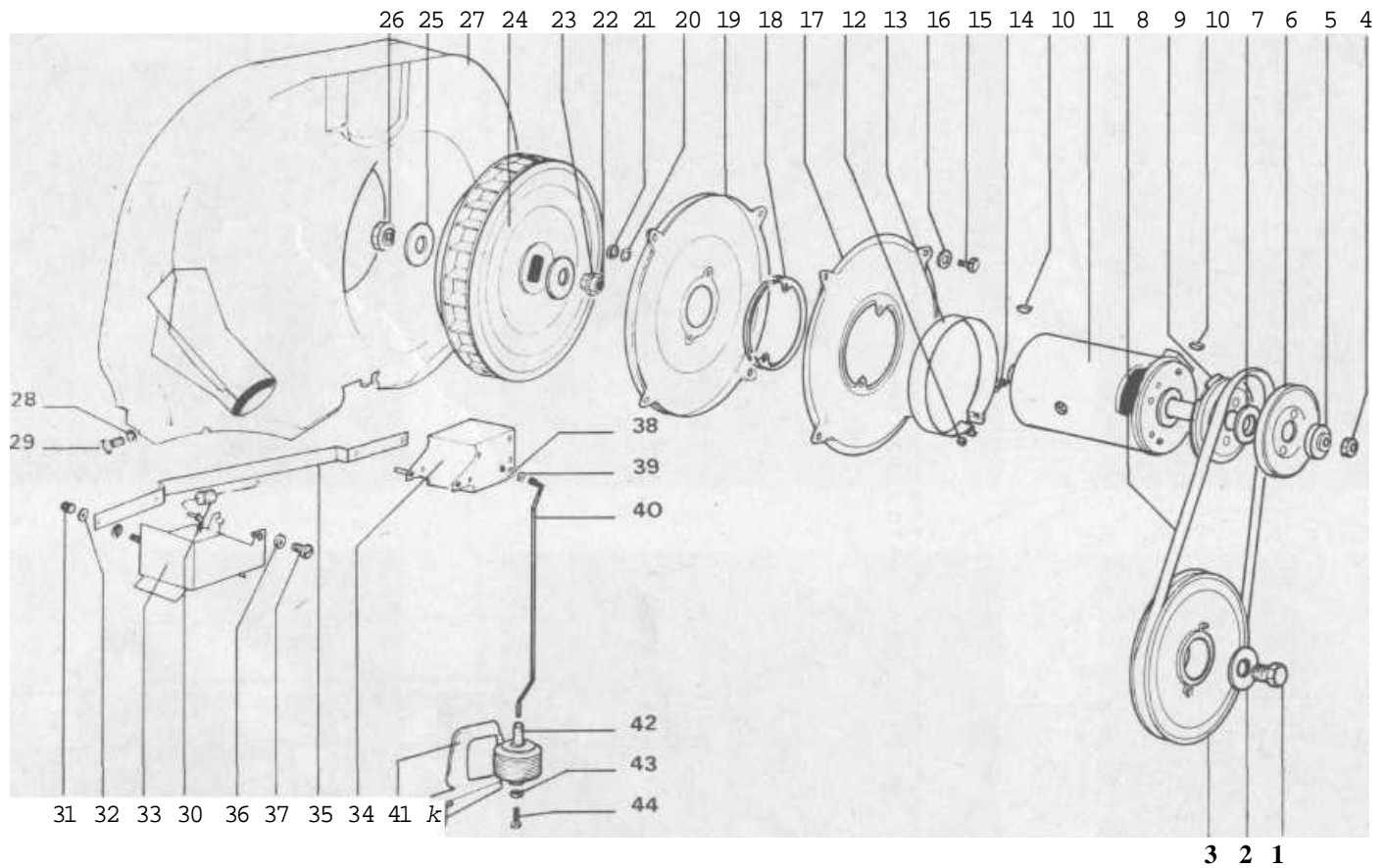
The condition and fit of all the cover plates is important. Sealing strips and grommets must all be properly positioned. If air leaks out the cooling capacity is reduced.

### 2 Removal of components - general

Apart from the fan belt, the fan/generator assembly, heat exchangers and exhaust system, the components and cover plates fitted to the engine cannot be removed unless the engine is taken out of the vehicle.

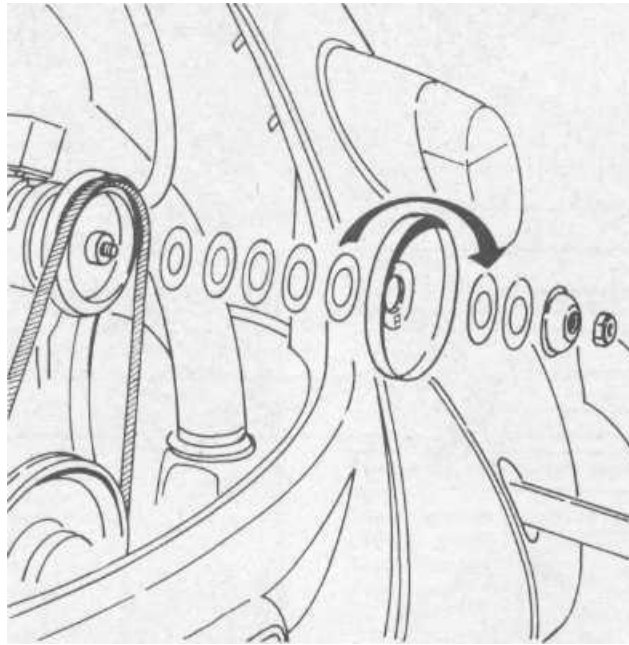
### 3 Fan belt - adjustment, removal and replacement

- 1 The Volkswagen fan belt needs more regular inspection than a water cooled engine fan belt usually gets because if it slips or breaks the consequences are more serious more quickly.
- 2 Adjustment takes a little more time than usual. There is no

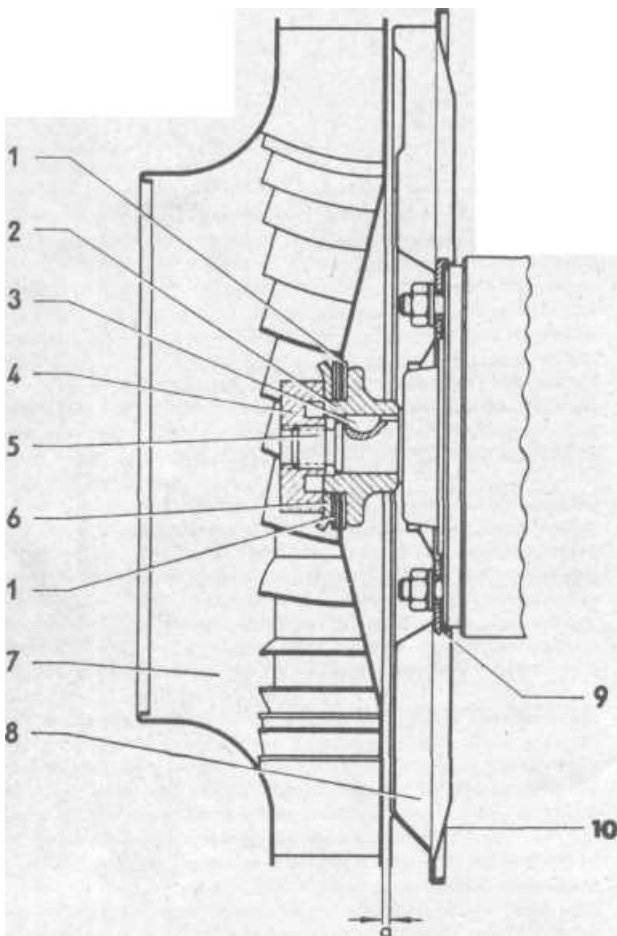


**FIG.2.1 FAN, FAN HOUSING AND THERMOSTAT**

- |                        |                       |                         |                      |                                 |                       |
|------------------------|-----------------------|-------------------------|----------------------|---------------------------------|-----------------------|
| 1 Pulley securing bolt | 9 Pulley - front half | 17 Outer fan cover      | 25 Lockwasher        | 33 Cooling air regulator, left  | 39 Washer             |
| 2 Dished washer        | 10 Woodruff key       | 18 Reinforcement flange | 26 Special nut       | 34 Cooling air regulator, right | 40 Connecting rod     |
| 3 Crankshaft pulley    | 11 Generator          | 19 Inner fan cover      | 27 Fan housing       | 35 Regulator connecting rod     | 41 Thermostat bracket |
| 4 Pulley nut           | 12 Nut                | 20 Lockwasher           | 28 Washer            | 36 Washer                       | 42 Thermostat         |
| 5 Washer               | 13 Generator strap    | 21 Nut                  | 29 Cheese head screw | 37 Cheese head screw            | 43 Lockwasher         |
| 6 Pulley - rear half   | 14 Bolt               | 22 Fan hub              | 30 Return spring     | 38 Lockwasher                   | 44 Bolt               |
| 7 Spacer washer        | 15 Bolt               | 23 Shim                 | 31 Spring            |                                 |                       |
| 8 Vee belt             | 16 Lock washer        | 24 Fan                  | 32 Washer            |                                 |                       |

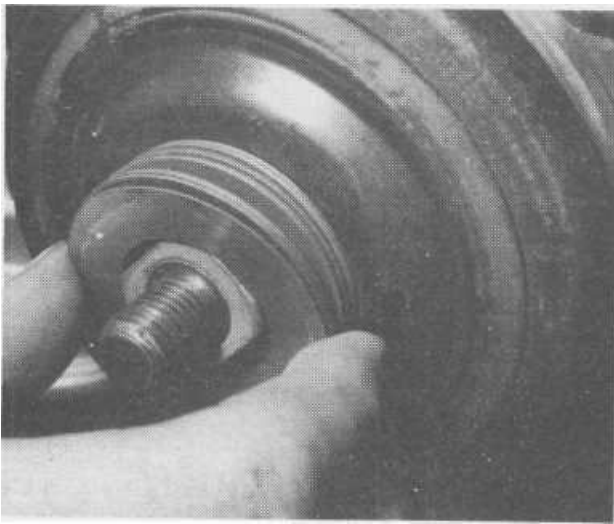


**FIG.2.2 SPLIT PULLEY FOR FAN BELT SHOWING SPACERS WHICH MAY BE MOVED TO ADJUST BELT TENSION**

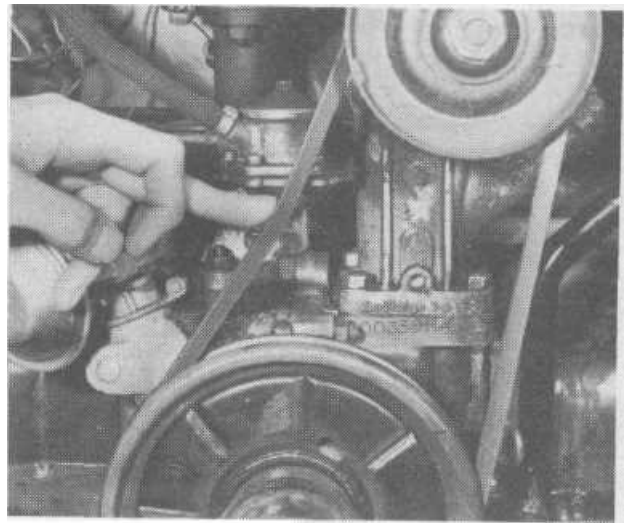


**FIG.2.3 FAN ASSEMBLY - CROSS SECTION**

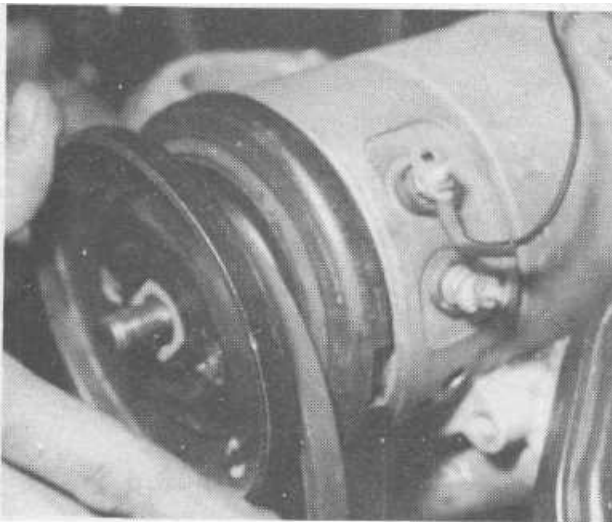
- |   |                 |    |                  |
|---|-----------------|----|------------------|
| 1 | Spacer washers  | 7  | Fan              |
| 2 | Fan hub         | 8  | Fan cover, inner |
| 3 | Woodruff key    | 9  | Flange           |
| 4 | Retaining nut   | 10 | Fan cover, outer |
| 5 | Generator shaft | a  | = 2 mm (0.08 in) |
| 6 | Shaped washer   |    |                  |



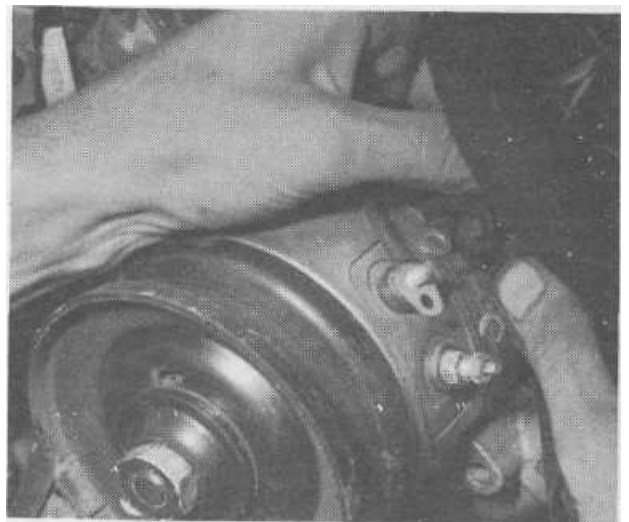
3.2 Positioning pulley spacers



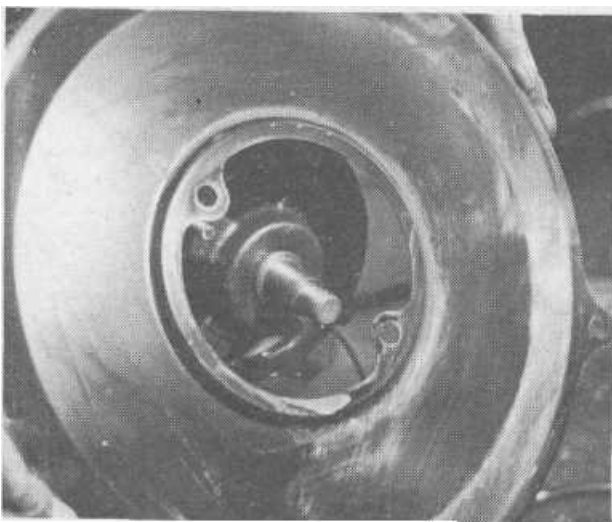
3.3 Checking fan belt tension



3.4 Fitting the outer half of the fan pulley



4.3 Disconnecting the dynamo leads



4.1 Oa Fitting the fan outer cover to the dynamo



4.10b and the stiffening plate.

tension pulley. The pulley on the generator is split into two and the gap between the two halves governs the effective diameter. The gap is regulated by spacer rings (photo). If the belt is too slack the gap between the two halves is decreased by removing one or more spacer rings. Spare spacers are fitted to the outside of the pulley.

3 The belt is correctly tensioned when firm pressure on the belt midway between the two pulleys causes a deflection of 9-10 mm (photo).

4 To remove the belt and split the pulley, lock the pulley first with a screwdriver in the edge of the inner flange against the top generator bolt. Remove the nut and clamp ring. The outer half of the pulley can then be separated from the inner half. To tighten the fan belt remove one spacer from between and then replace everything (with the moved spacer now on the outside of the pulley) and try the tension again. Take care when refitting the outer half of the pulley to get it square (photo). It helps if the engine is rotated. This will get the belt into its 'running' position. The engine is rotated with a spanner on the crankshaft pulley wheel. Continue removing spacers until the tension is correct. If all the spacers are out and the belt is still slack it is over-stretched and must be renewed.

5 Check the tension of a new belt after a few hundred miles running as initial stretch may need taking up.

#### 4 Fan and dynamo - removal and replacement

1 The fan and generator have a common shaft and to separate them they must first be removed together from the engine. This involves:-

- a) Carburettor removal (see Chapter 3).
  - b) Raising the fan housing, which in turn requires removal of the thermostat as described in this chapter.
- 2 Remove the fan belt (Section 3).
- 3 Disconnect the battery to prevent accidental short circuits, remove the air cleaner and then disconnect the wires from the top of the generator. Tag the wires so that you know where to replace them (photo).
- 4 The generator is clamped to the pedestal by means of a metal strap. Undo the clamping bolt at the right and push the strap off forwards. If the engine is out of the car it is a good idea to slacken the fan nut before undoing this strap. The locking notch in the fan belt pulley can then be used to hold the shaft whilst the nut is slackened off. Put the fan belt pulley back on if you have already taken it off.
- 5 Undo the four bolts holding the fan cover plates to the fan housing.
- 6 Raise the fan housing (Section 5) and remove the generator and fan assembly from out of the fan housing and off the generator pedestal.
- 7 With the assembly out of the car, refit the fan belt pulley and clamp the generator body in a vice. The pulley is needed so that you can use the notch to lock the shaft whilst the fan nut is undone.
- 8 Once the nut has been removed the dished lock washer may be drawn off followed by the fan. Behind the fan is the thrust washer, spacer washers and fan hub which is keyed to the shaft.
- 9 The fan cover plates are held to the generator by two nuts on the ends of the generator through bolts. Note that the slot in the inner cover should face downwards when fitted to the generator, and the dished side goes into the fan housing. The purpose of the two covers is to provide a more positive suction point into the fan housing for cooling air drawn through the generator.
- 10 Reassembly and replacement should be done with care to ensure that the spacers and cover plates are correctly positioned.
- a) Fit the outer cover plate onto the dynamo through bolts (photo).
  - b) Fit the stiffening plate (photo).
  - c) Fit the inner cover plate so that the peripheral slot will face the bottom of the fan housing when the generator is the right way up (photo).
  - d) Note the spacer ring on the dynamo shaft. If it is missing the

fan hub will jam into the dynamo end cover (photo).

- e) Fit the fan hub and spacer washers (photo).
- f) Fit the fan to the hub (photo).
- g) Replace the special lock washer and nut (photo). The raised edges of the dished lock washer must be towards the nut.

11 Tighten the nut sufficiently to make sure that the hub is fully home. Then measure the gap between the fan and the cover plate which should be 2 mm (0.080 ins). If any alteration is needed remove the fan from the hub and increase or reduce the number of shims. Keep spare shims behind the fan nut lock washer. Tighten the fan nut to the final torque of 43 lb ft.

12 Replacement of the generator/fan assembly is a reversal of the removal procedure. Take care not to distort anything and get the clamp strap and fan backplate bolts all in position before any are tightened. See that the strap fits the contours of the pedestal bracket as before. This should not be a problem if the dynamo is seating positively in the pedestal. When all is tightened spin the fan to ensure that nothing is touching. If it is, the fan housing is not seated correctly or something is bent.

13 Later models have a smaller pulley (170 mm) diameter. The fan housing is also modified to incorporate an air deflector ring.

#### 5 Fan housing - removal and replacement

1 With the engine in the car the fan housing may need to be raised a little in order to enable the fan/generator assembly to be taken out. To do this the thermostat bellows under the right pair of cylinders must be unscrewed so that the rod to which it is attached, and to which control flaps inside the housing are attached at the other end, may be raised also. The thermostat is accessible after removing the duct plate under the right pair of cylinders (see Section 7).

Then remove the two cheese head screws, one at each side of the fan housing. The housing may then be raised.

2 If the fan housing is being removed solely for access to the engine for further dismantling it can be taken off together with the fan and generator when the engine is out of the vehicle.

3 On later models the fan housing is a little more complicated because the oil cooler is set further forward. Additional cover plates duct the air which has passed the oil cooler straight out rather than past the cylinders. To reach round for the retaining screws on these models is difficult, particularly on replacement.

4 In addition the return spring on the air flap link rod across the front of the fan housing must be disengaged. The clip at the left hand end should also be removed so that the link lever may be swung clear of the oil cooler when the housing is lifted.

5 It is not possible to see what you are doing when the engine is installed so it is advisable to make yourself familiar with the position of the various parts by careful study of the photographs.

6 The upper part of the outlet duct for the oil cooler is held by a nut on a stud fixed to the fan housing. When this piece is moved off the stud it can be lifted out. (photo)

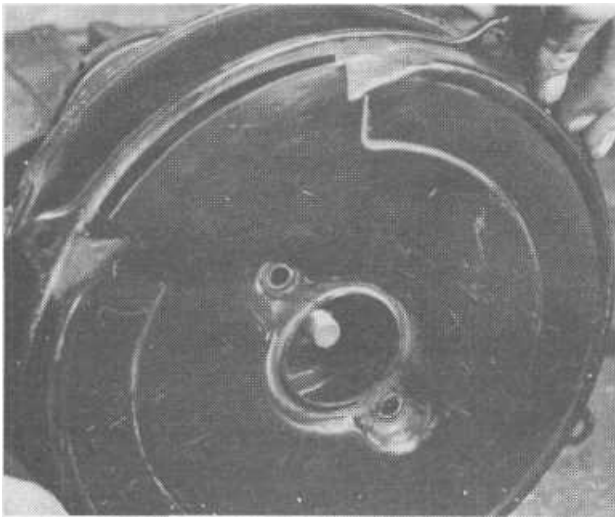
7 The lower section is held by a screw which once removed will allow the lower section to be lifted up and out. Note that it fits through an opening in the vertical front cover plate, (photos)

8 Whenever the fan housing is removed - for whatever reason - the opportunity should be taken to examine the condition and operation of the air flaps inside (photo). If these stick shut at any time the engine will overheat. If they are in a very poor condition and the expense of renewing them does not appeal, the best thing to do is remove them altogether. Their function is merely to shorten the warming up time and only in extremely low temperatures (well below freezing) is the engine likely to run over cold.

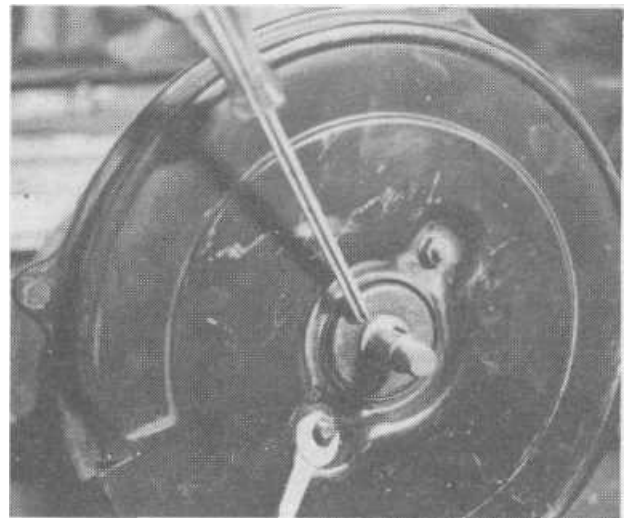
9 Replacement of the fan housing is the reverse of this procedure. If however, the engine is out of the car and being re-assembled after an overhaul the following points should be noted.

10 Before putting the housing back onto the engine the cylinder top cover plates should be in position.

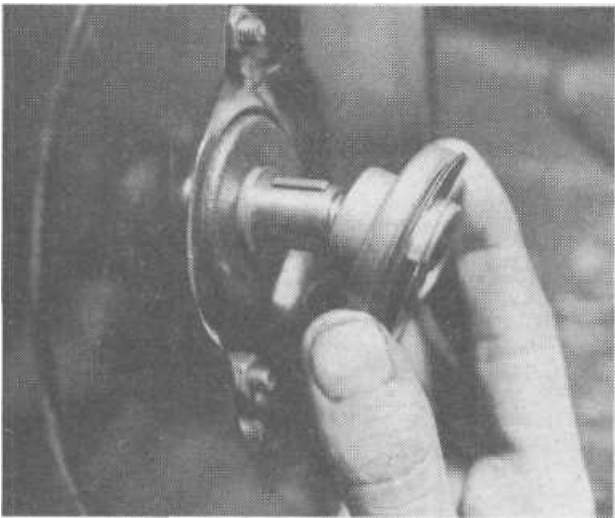
11 If the fan housing is being fitted together with the generator and fan attached, then the centre section of the inlet manifold



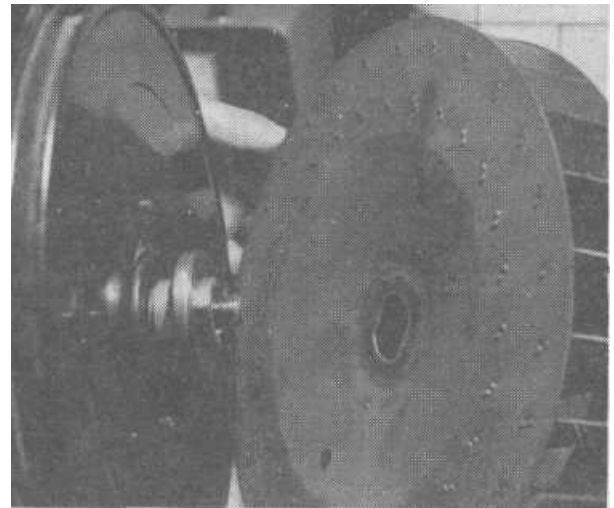
4.10c Fit the inner cover plate



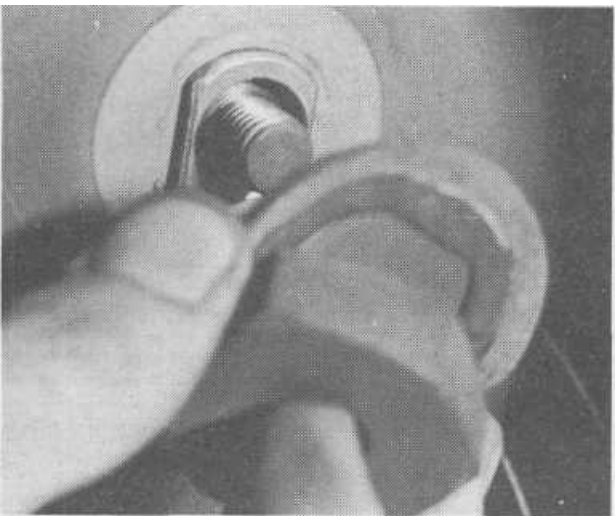
4.1 Od Note the spacer on the dynamo shaft



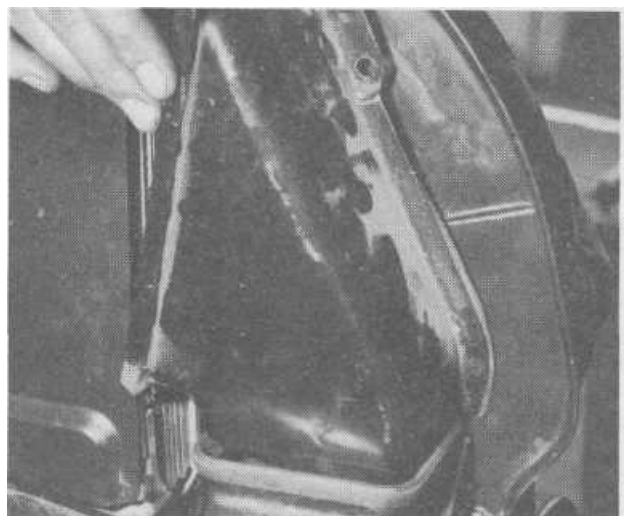
4.1 Oe Fit the fan hub and shims.....



4.1 Of .... followed by the fan.



4.1 Og Secure with the lockwasher and nut



5.6 Removing the upper part of the oil cooler duct

(the whole manifold on earlier models), should first be positioned. It cannot be manoeuvred between the housing and the generator pedestal afterwards.

12 Continue with reassembly by carefully lowering the fan housing over the oil cooler. The pull rod for the thermostat control should go through the cylinder head aperture nearest the crankcase (photo).

13 The base of the fan housing should fit snugly inside the apertures of the cylinder cover plates. Make sure that the dynamo locates correctly in the pedestal.

14 Replace and tighten the dynamo securing strap and then tighten the screws at each side of the fan housing (photo).

15 On later models the vertical front plate should be positioned before the two oil cooler cover plates are refitted (photo). When refitting the upper oil cooler cover a little pressure will be needed to get the fixing hole over the stud.

16 Reconnect the flap connecting lever and clip. Refit the return spring (photos).

17 Refit the fan belt ensuring that it is tensioned correctly.

18 Replace the carburettor and air cleaner, and adjust the accelerator cable.

## 6 Heat exchangers - removal and replacement

1 Remove both the air hoses from the fan housing at the lower ends and take out the screws securing the semi-circular plate round the inlet manifold pre-heater pipe. Take off the air cleaner pre-heater hose at the lower end.

2 Remove the securing screws and lift out the pulley cover plate.

3 Disconnect the warm air duct hose from the front of the heat exchanger underneath the car.

4 Disconnect the control wire from the operating lever by undoing the clamping screw in the toggle (photo). This will probably be rusty and dirty so use plenty of penetrating oil otherwise you could break something which would just add to your repair list.

5 Take off the lower duct plate between the engine and the heat exchanger.

6 The front exhaust pipe flange should then be released by undoing the two nuts and the rear exhaust connection by undoing the clamp. The heat exchanger inlet duct is clipped to the main exhaust silencer unit also as this has a small heat exchanger section on it. Undo this clip (photo).

7 By moving the heat exchanger forward off the front exhaust studs (photo) it will then be possible to lower and remove it.

8 Before replacing a heat exchanger it should be examined carefully for signs of splits. If it is damaged due to impact but otherwise sound it might be worthwhile having it straightened and/or welded. Otherwise fit a new one. Make sure also that the faces of the exhaust pipe flanges are perfectly flat. If they are distorted, steps must be taken to remedy the situation. Always fit new gaskets.

9 The replacement of the heat exchanger is a reversal of the removal procedure. Make sure that when it is offered up all the joints fit true and flush before the nuts and clamps are tightened. If the nuts and clamps have to be used to force the unit into position, rather than hold it in position, stresses will be set up and something will break sooner or later. Certainly sooner than it would normally.

10 After reconnecting the control wire operate the lever to ensure that the arm moves through its full range.

## 7 Thermostat and controls - removal, replacement and adjustments

1 The thermostat controls flaps which restrict the air flow but do not completely obstruct it. If it should fail to operate therefore the engine will only be noticeably overheated in extreme conditions of high temperatures or hard use. The only indications of overheating are either a noticeable fall off in performance or the oil warning light indicating an exceptionally low oil pressure. It is essential to stop immediately either of these

conditions appear as the engine will already have reached an undesirable state and will be seriously damaged if allowed to continue.

2 To check the operation of the flaps it is necessary to get access to the thermostat first. This is done by removing the right hand duct plate under the cylinders. Remove the screws holding it to the heat exchanger and crankcase. The thermostat is accessible once the right hand plate is removed. To set the flaps first remove the bolt securing the bellows to the bracket (photo). Then make sure that the bellows is screwed fully on to the operating rod. Slacken the bolt which holds the bracket to the crankcase and then push the bellows unit upwards so that the flaps are fully open. The top of the bracket loop should now just touch the top of the bellows and the bracket bolt may be tightened. Then replace the bolt securing the bellows to the bracket (which will involve pulling the bellows down and closing the flaps if the engine is cold). If the thermostat is suspected of malfunctioning a check can be made on its length (excluding the projecting screwed bosses at each end) which should be at least 46 mm (1.8 inch) at a temperature (in water) of 65-70°C (150-158°F) or more. If you wish to set the thermostat so that the flaps are always open (i.e. if the bellows do not work and you have no immediate replacement) push the bellows and bracket up together into the 'flaps open' position and clamp the bracket at the raised position.

3 If the flaps themselves are suspected of jamming or being out of position on their spindles then the fan housing must first be taken off as described in Section 5. Both flap housings can be removed from the fan housing together once the eight securing screws are removed and the return spring unhooked. Examine the flaps and spindles for security and ability to stay in position. Once again, if there should be some doubt and the flaps are likely to jam shut they can be removed completely.

## 8 Heater controls flaps and outlets - checking and setting

1 As previously explained the car is heated by ducting hot air from exchangers surrounding the exhaust pipes. When hot air from the exchanger is required the flap is opened so that the air pressure from the fan housing will carry it into the car. The warm air from the cylinder cooling fins has nothing to do with the heating system.

2 Should the heater efficiency drop the first thing to check is the operation of the flap control wires. These are connected to the flap operating arm on the side of the heat exchanger by means of a ferrule on the end of the wire clamped into a clevis. The clevis pin clamp screws are usually rusty so lubricate them well beforehand.

3 Once slackened the end may be pulled out. /

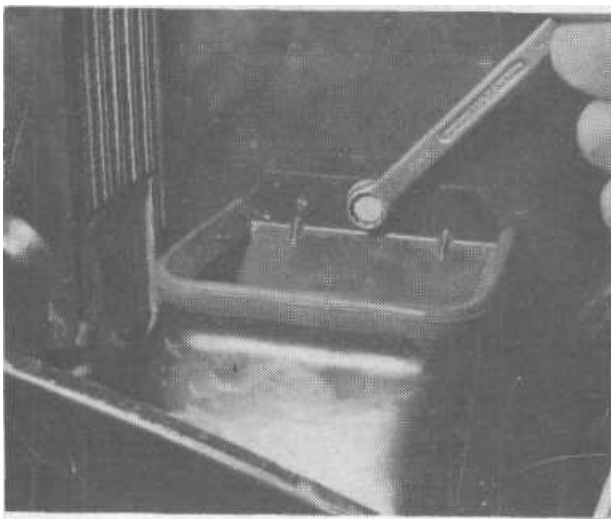
4 In order to remove the instrument panel t/ie four control levers must be first removed. Access to them/s via the central aperture in the dash panel where a radio would fit. The lever ends are secured by plastic plugs which may be pushed out. There are leaf springs installed between the two levers to act as an anti-rattle measure (photo).

5 Normally no adjustment is necessary. If the heater cables have been detached from the rear then there should be adequate adjustment at the cable clamp to ensure full movement of the heater flap. The fresh air flaps at the front do not normally alter. However the levers have a choice of holes into which the link rod may be fitted and the link rod itself is adjustable if needed.

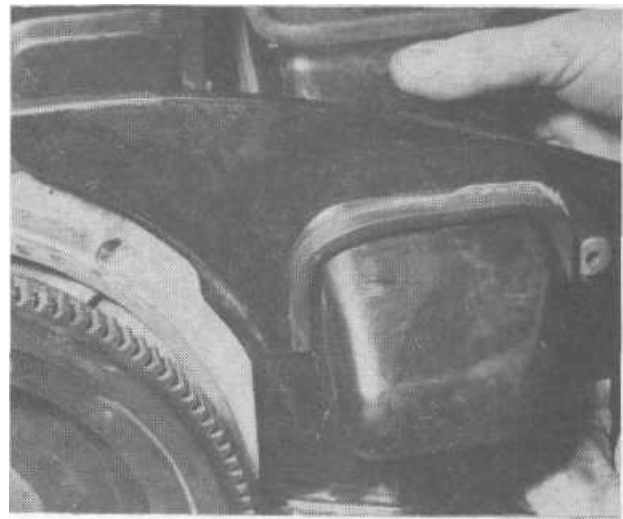
6 The function of the controls needs to be understood. The two blue handled levers operate the fresh air inlet flaps at the front. This fresh air is ducted to the outer slots at the base of the windscreens or the circular adjustable outlets at each side of the dash board. If the circular outlets are closed all fresh air is directed on the screen. The air flow is quite independent of the heater system. Each lever controls its own side of the cab.

7 The heater levers each open one of the two heat exchanger flaps on the engine at the rear. The hot air from both exchangers is channeled into one duct which comes up vertically in the cam centre under the dash. The vertical pipe is fitted with a flap controlled aperture which lets out hot air into the lower part of

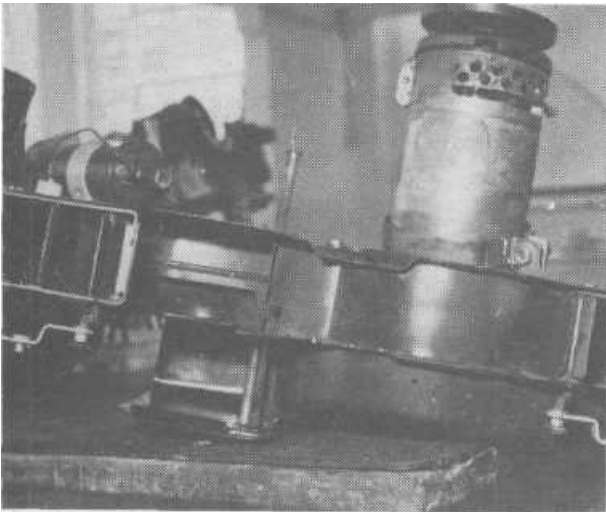




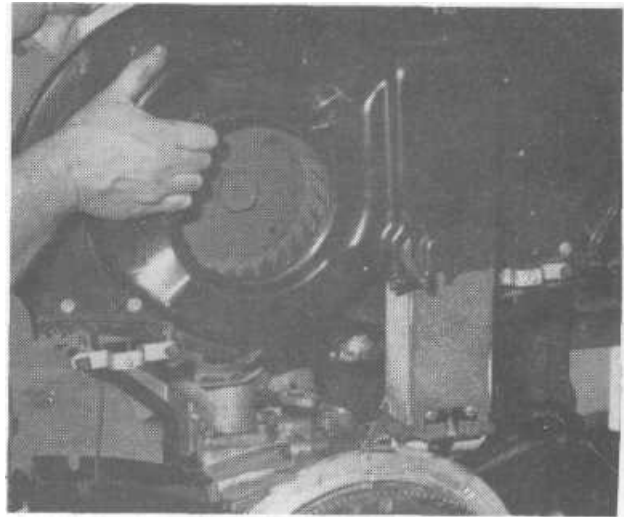
5.7a Removing the lower half of the oil cooler duct



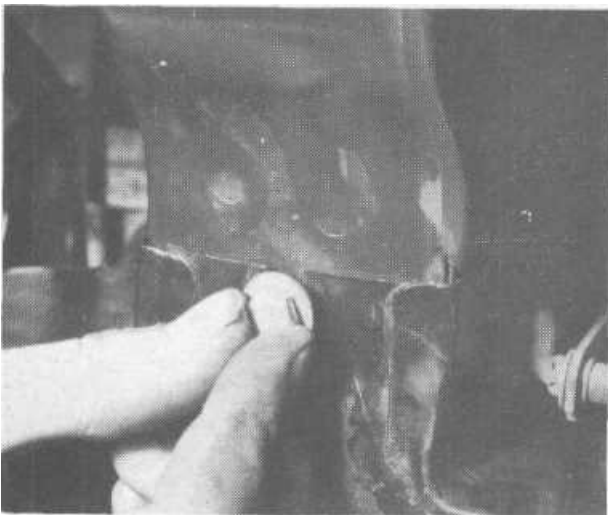
5.7b Lifting the duct from the vertical plate



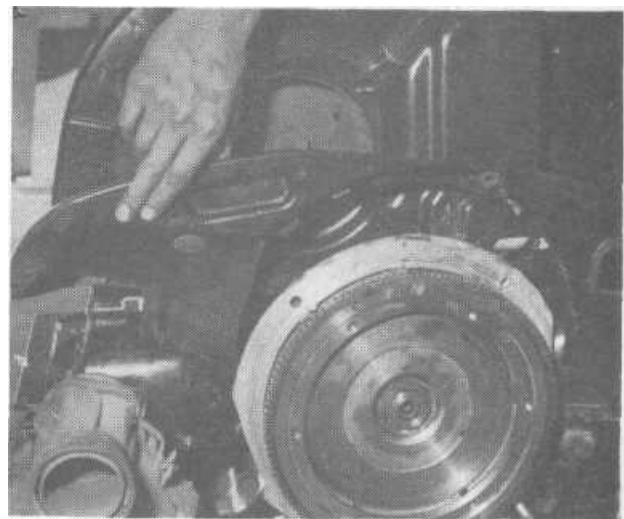
5.8 Looking at the underside of the fan housing showing the thermostatically controlled air baffle plates



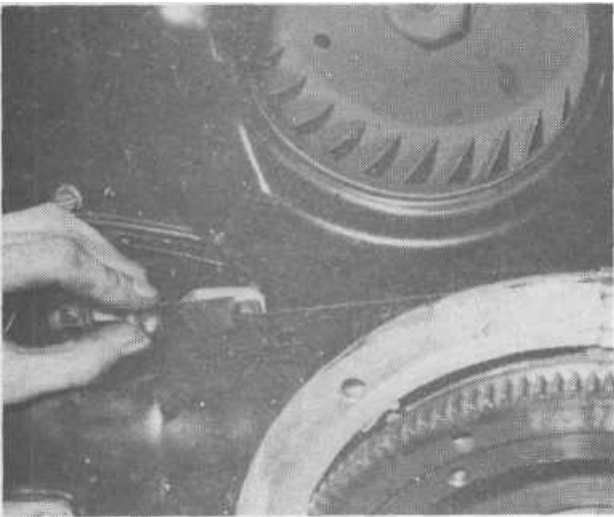
5.12 Guiding the thermostat rod through the cylinders



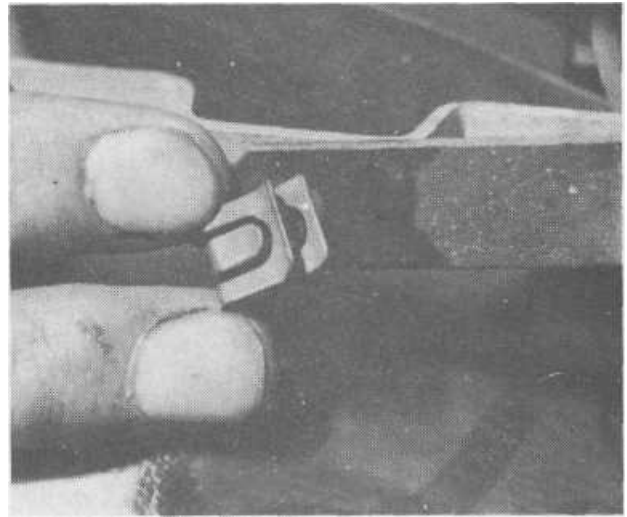
5.14 Tightening the fan housing side screws



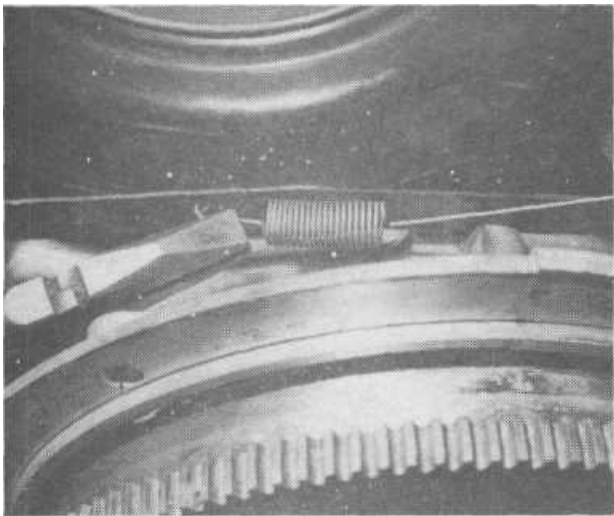
5.15 Front plate being positioned



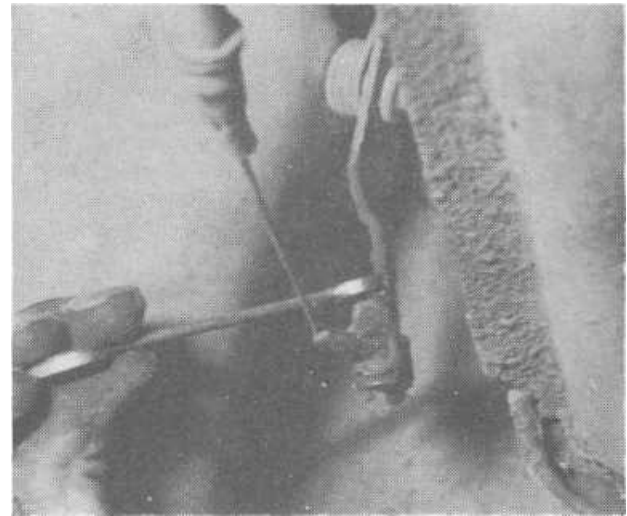
5.16a Replace the connecting rod for the fan housing baffle plates



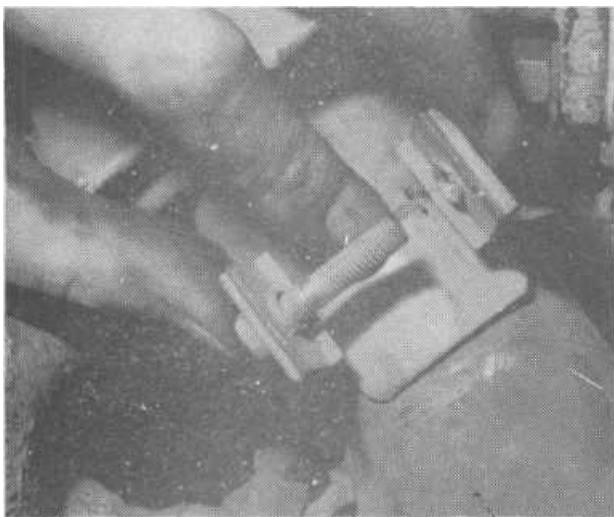
5.16b Securing the special clips



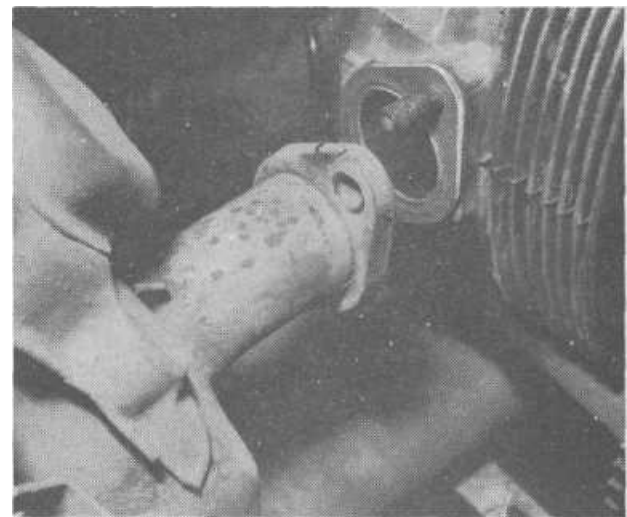
5.16c. . . . and return spring



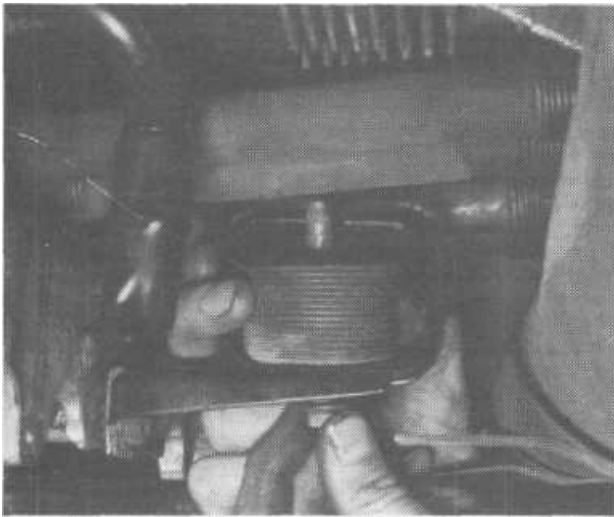
6.4 Unclamping the heat exchanger control cables



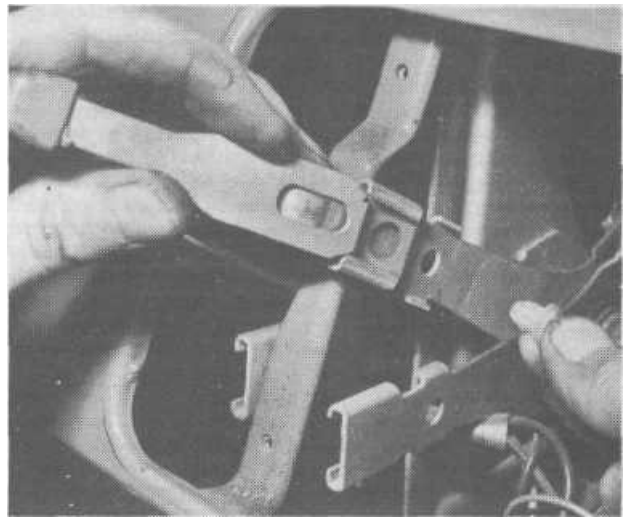
6.6 Undoing the heat exchanger sleeve clip



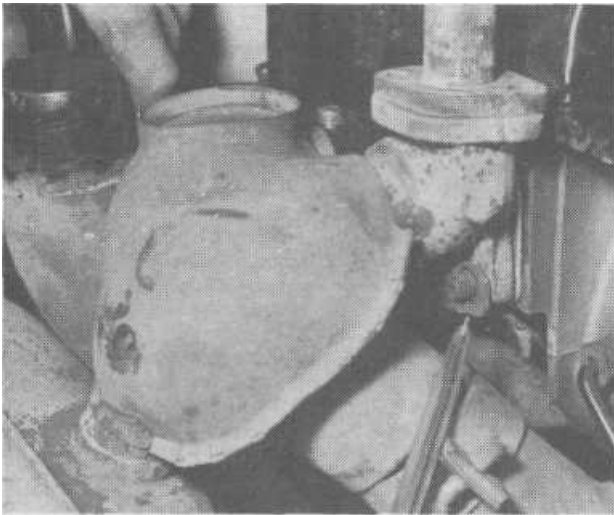
6.7 Drawing the heat exchanger off the front studs



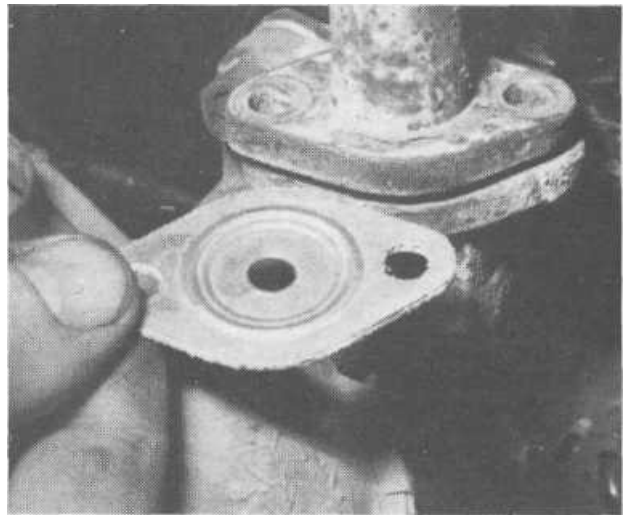
7.2 Slacken the thermostat bellows mounting screw



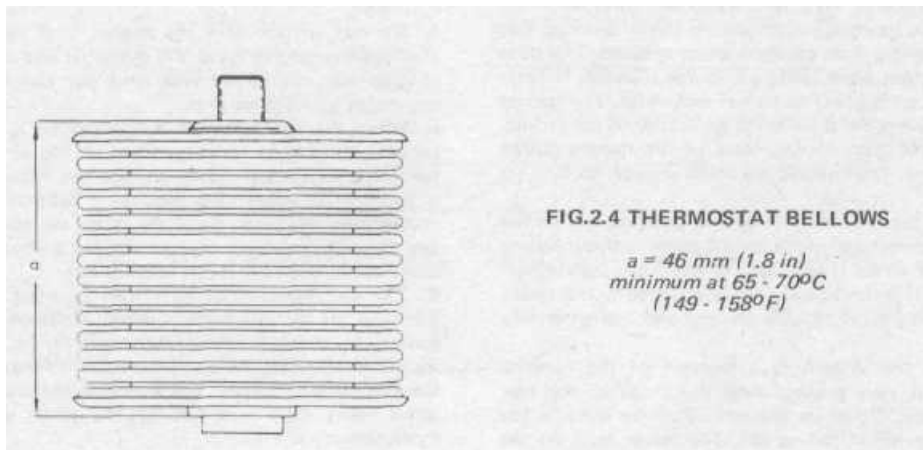
8.4 The heater control lever showing plastic plug



9.7a The lower stud also carries the warm air intake pipe bracket for the carburettor air cleaner



9.7b Do not use any pre heater gasket with a small hole,



the cab or lets it continue to the two inner slots at the base of the windscreen. The heater output is therefore controlled by use of the two levers and the hot air direction can be balanced between floor and screen.

8 Passenger carrying models have two heater outlets in the floor at the rear, one at each side and each with an independent flap control knob. The ducts to these come from the combined outlet pipe and when they are in use it will mean a corresponding reduction in hot air flow at the forward part of the vehicle.

9 Heater efficiency depends on all hoses and connections being sound and tight and the flap control cables being correctly set and operating the flaps over their full range.

### 9 Exhaust system - removal, inspection and replacement

1 The Volkswagen exhaust and silencer is a complex unit made of heavy gauge material, which is expensive to replace. See Fig. 2.5 and 2.6. The silencer and tail pipe assembly is connected at five points on each side. These are:

- a) To the exhaust pipes coming from the front of the cylinder heads through the heat exchangers (clamps).
  - b) To the exhaust ports on the rear of the cylinder heads (flanges).
  - c) To the inlet manifold pre-heater pipes (flanges).
  - d) To the heat exchangers (sleeve clips).
  - e) To the air inlet hoses from the fan housings (clips).
- The exhaust manifold incorporates a small heat exchanger shrouding the upper pipes.

2 To remove the exhaust/silencer unit first remove the nuts, bolts and clamps which attach the assembly at the ten locations. If some of the underside nuts and bolts are badly rusted buy new ones before attempting to get the old ones off. It is quite usual for them to break or need cutting. A complete set of the gaskets should also be acquired (two exhaust flange, two inlet manifold flange, two clamp rings) before disturbing the unit.

3 Once all the connections are loosened the silencer can be drawn backwards off the studs of the cylinder head rear exhaust ports and lowered to the ground.

4 The Transporter differs from the other vehicles in that the exhaust is carried away from the silencer to the side of the vehicle through a damper pipe to the tail pipe.

This extra pipe work will come away with the rest of the silencer. Details of it are given in Fig. 2.6. should it be necessary to dismantle it for any reason.

5 Depending on the reason for removal subsequent inspection and repair will have to be judged in the light of the seriousness of deterioration. The unit is made of heavier gauge material than more conventional exhaust systems. Thus small holes or cracks in the silencer may be patched and welded in the knowledge that the repair will last longer than on some other systems. This does not apply to the actual pipes leading into the silencer. If these are unserviceable repair is likely to be less successful. The flanges and connection to the other pipes must be examined for pitting, distortion or fractures. The mating faces of the flanges can be filed flat if necessary. The gaskets are thick enough to take up minor variations.

6 Before replacing the unit offer it up into position so that the line up of all the connecting points can be made without having to strain anything. If strain is necessary to make any connection then the likelihood of a fracture developing is greatly increased. It is worthwhile taking some trouble to heat and straighten any twisted parts.

7 Replacement of the system is a reversal of the removal procedure. First put new gaskets over the studs at the rear exhaust posts (photo). Offer up the unit. Put the nuts on the studs enough to prevent it falling off. The lower stud on the

right hand mounting also secures the hot air intake pipe which warms the air for the carburettor (photo). Then assemble the lower gasket rings and clamps loosely - but sufficiently tight to prevent them becoming dislodged. Then fit the pre-heater pipe gaskets in position and replace the bolts loosely. Note that the gaskets for each end of the pre-heater pipe should be the same - each having a hole equal to the pipe diameter. Do not fit a gasket with a small hole (photo).

8 The pipe clamp and flange bolts and nuts should be progressively tightened a little at a time until fully tight. Do not overdo the tightening on any of them. Finally tighten the heat exchanger clips. After running the engine for some miles, so that it has had the opportunity to heat up and cool down a few times, recheck the connections for tightness.

9 The following components have been modified on later models and as spare parts.

Damper /tailpipe now in one piece.

Tailpipe internal diameter increased to 1.3 in (33 mm) diameter.

Damper pipe internal diameter increased to 1.4 in (36 mm) diameter.

### 10 Supplementary heaters

1 For markets where extremely low temperatures are frequently encountered the heat exchanger system is not adequate to maintain the vehicle interior at an acceptable temperature. In these cases a separate heater unit is installed at the rear in the engine compartment. These units consist of a fan/combustion unit which uses petrol as a fuel, see Figs. 2.7 and 2.8. There is a special combustion chamber and the petrol is ignited by spark and glow plugs. Hot air is blown into the regular system distribution. The combusted gases are exhausted under the vehicle.

2 The heater unit is a relatively sophisticated piece of equipment for such a mundane task. When operating it consumes approximately 0.2-0.65 litres/0.35-1.1 pints per hour. It is fitted with a glow/spark plug which provides for initial warm up and then continuous ignition of the mixture. The electrode gap should be maintained at 0.10 in (2.54 mm).

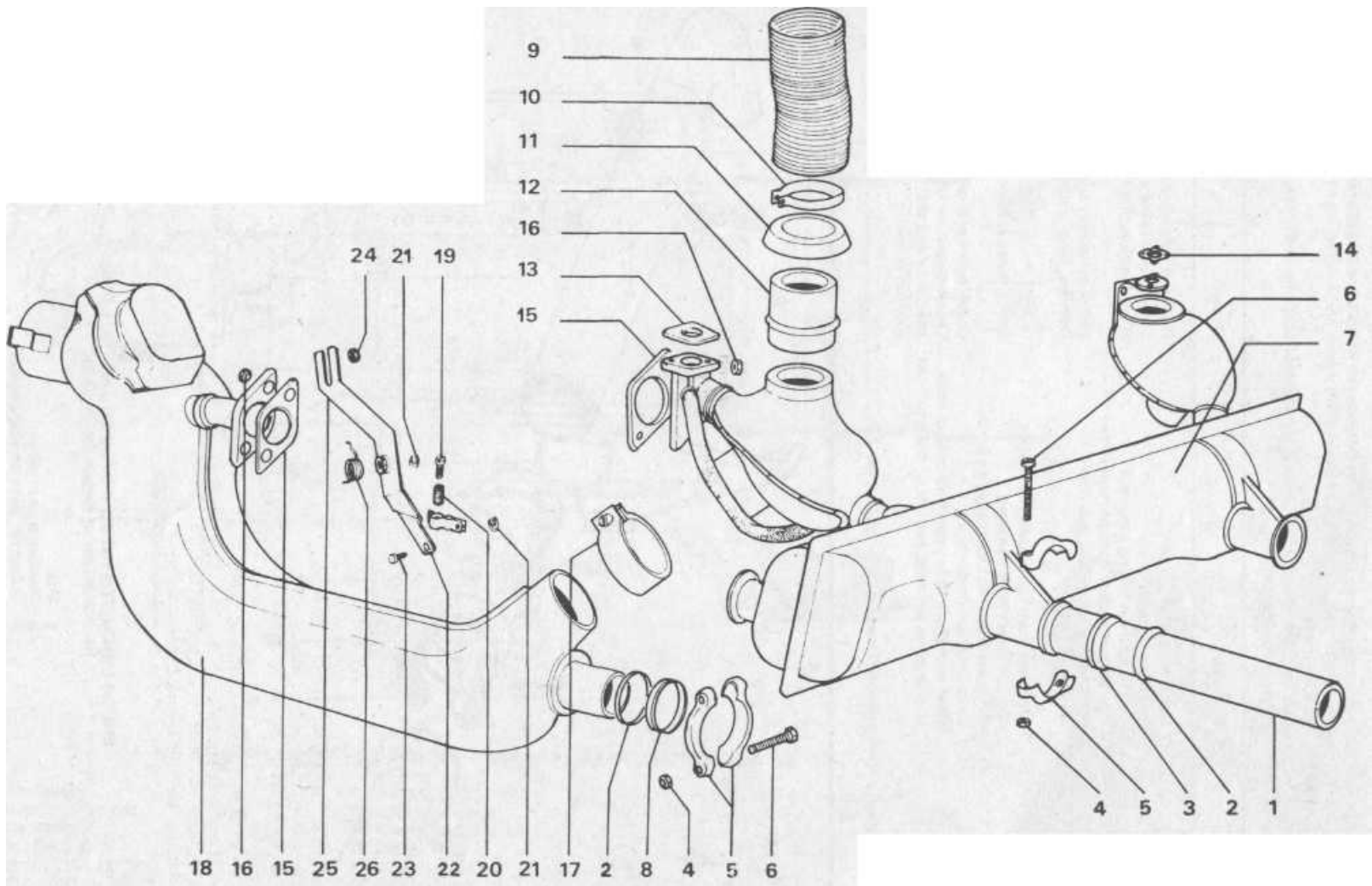
The glow plug circuit is automatically switched off when working temperature is reached. Fail safe devices ensure cut off in the event of overheating and cut off in the event of non-ignition so that petrol does not continue to be pumped.

3 It is good practice to use the heater at regular intervals whether it is needed or not. Maintenance consists of checking the spark and glow plug operation if for any reason the heater has been left unused for a long time. It is also important to ensure that all electrical connections are tight and free from corrosion.

4 Do not tamper with the heater. If it fails to work have it checked thoroughly by a VW dealer. If any of the safety cut out circuits are interfered with and put out of action the consequences could be serious.

5 When the heater switch is first put on it may take anything up to a minute or so (depending on the ambient temperature) for ignition to occur - even though the fan will be running. This is because the glow plug requires a little time to warm up the combustion chamber. Similarly, after the heater is switched off the fan will continue to run on for a short time so that the combustion chamber is not left too hot.

6 The supplementary heater may be used when the engine is switched off but the current drawn is about 9 amps at start up, settling to about 4 amps when warmed up. For this reason it should not be used for more than about 10 minutes at most with the engine not running. If the engine is dead cold and likely to put a heavy load on the starter the heater should be used even more circumspectly.



**FJG.25 EXHAUST SYSTEM AND MOUNTINGS**  
(for Damper pipe, tail pipe and fittings see Fig.2.6)

- |                    |                  |                             |                          |                      |                               |
|--------------------|------------------|-----------------------------|--------------------------|----------------------|-------------------------------|
| 1 Tail pipe        | 6 Clamp bolt     | 11 Grommet                  | pipe (right)             | 18 Heat exchanger    | 23 Pin                        |
| 2 Retaining ring   | 7 Silencer       | 12 Connecting pipe          | 15 Gasket - exhaust pipe | 19 Bolt              | 24 Clamp washer               |
| 3 Seal             | 8 Seal           | 13 Gasket - pre-heater pipe | flange                   | 20 Pin               | 25 Heater flap lever (left)   |
| 4 Self-locking nut | 9 Air inlet hose | 14 Gasket - pre-heater      | 16 Self-locking nut      | 21 Circlip           | 26 Lever return spring (left) |
| 5 Clamp            | 10 Hose clip     |                             | 17 Clamp                 | 22 Heater cable link |                               |

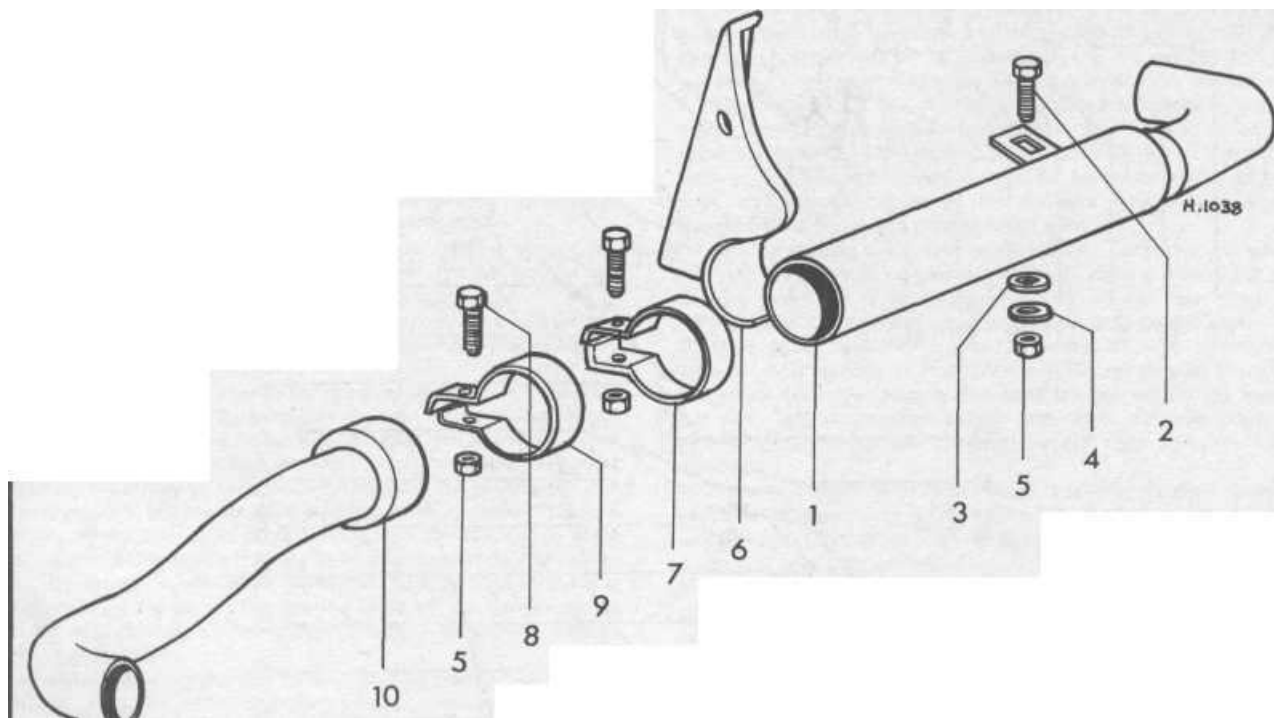
## 11 Faultfinding

It is difficult to detect heating systems faults in a rear engined air cooled car because the tell-tale head of steam is not there to show and no temperature gauges are used. The first indications of over heating are a falling off in power and a flickering of the oil pressure warning light. When this occurs the car must be stopped immediately.

Over cooling is a rare experience in anything but sub-zero temperatures, even if the thermostat control was to be stuck wide open. Possible causes of over heating and heater inefficiency are tabled below.\*

Symptom	Reason/s	Remedy
Overheating	Slack or broken fan belt Insufficient engine oil Engine ignition timing incorrect Thermostat and/or control flaps in fan housing stuck in closed position Oil cooler blocked	Renew if necessary and re-adjust tension. Top up as necessary and check for leaks. Reset ignition timing.  Check operation and free as necessary. Remove, have tested and renew if necessary.
Heater ineffective	Air hoses from fan housing to heat exchanger insecure or damaged Air hoses from heat exchanger to car interior insecure or damaged Heat exchanger flaps operating control arms and/or wires jammed, broken or disconnected	Check hoses and secure or renew as needed.  Check hoses and secure or renew as needed. Check operation of control cables and operating arms and that arms are moving the flap spindles properly.

\*For fault diagnosis on supplementary (fuel operated) heaters, refer to Chapter 12.



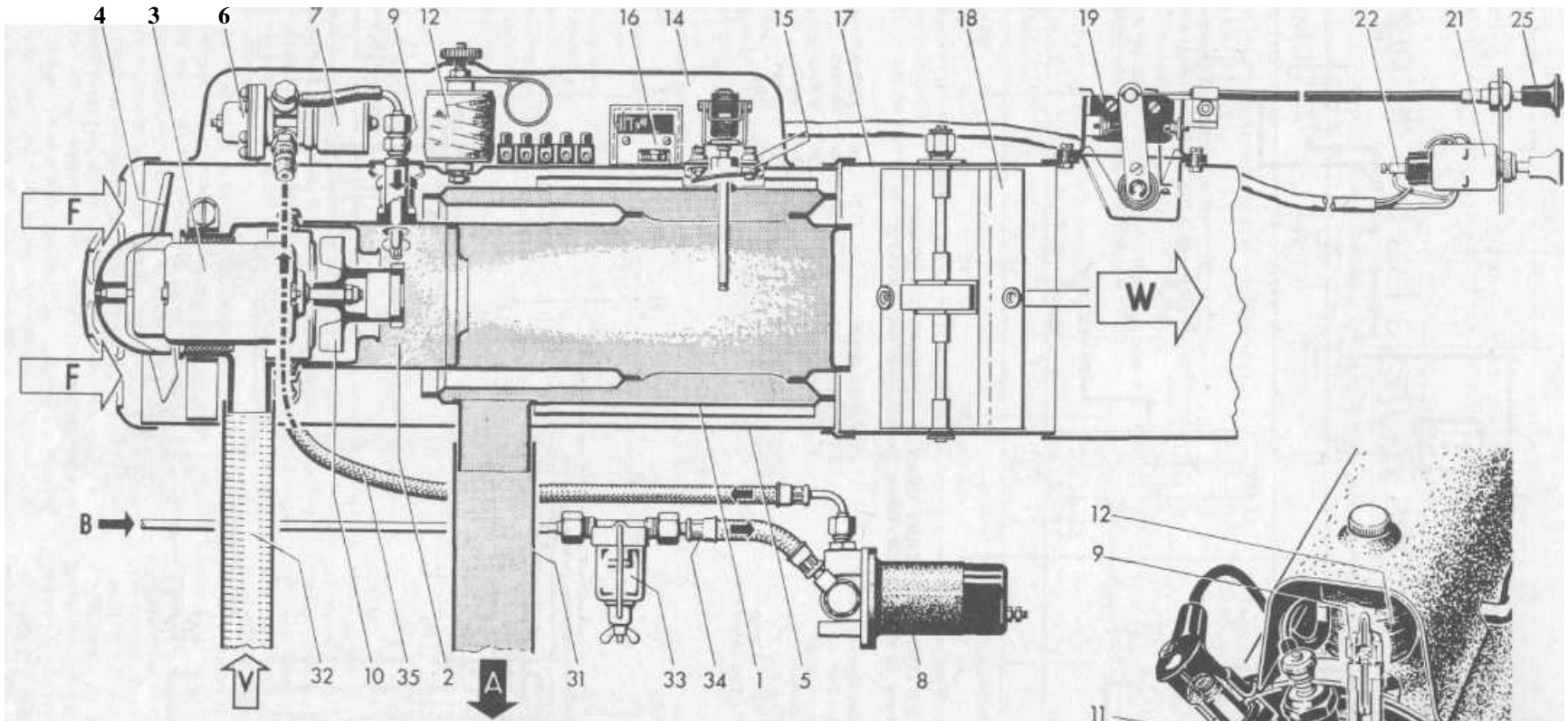
**FIG.2.6 EXHAUST SYSTEM - DAMPER AND TAIL PIPE**  
(for remainder of system see Fjg.2.5)

- 1 Damper pipe
- 2 Bolt
- 3 Washer
- 4 Lockwasher

- 5 Bolt
- 6 Damper pipe bracket
- 7 Clamp for damper pipe bracket

- 8 Bolt
- 9 Clamp for tail pipe
- 10 Tail pipe





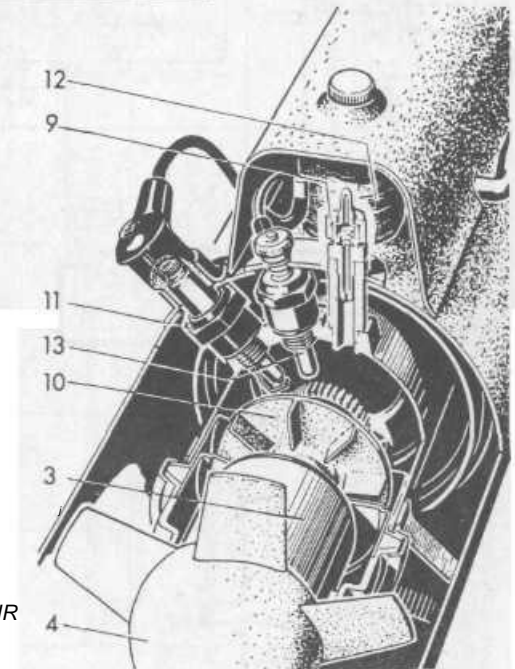
**VRY HEATER - DIAGRAMMATIC SECTION (Sec 10)**

- 7 Heat exchanger
- 2 Combustion chamber
- 3 Electric motor
- 4 Blower, fresh air
- 5 Casing
- 6 Regulator (pressure)
- 7 Solenoid valve
- 8 Fuel pump
- 9 Fuel jet
- 10 Combustion air blower
- 11 Spark plug (2 pole)
- 12 Coil

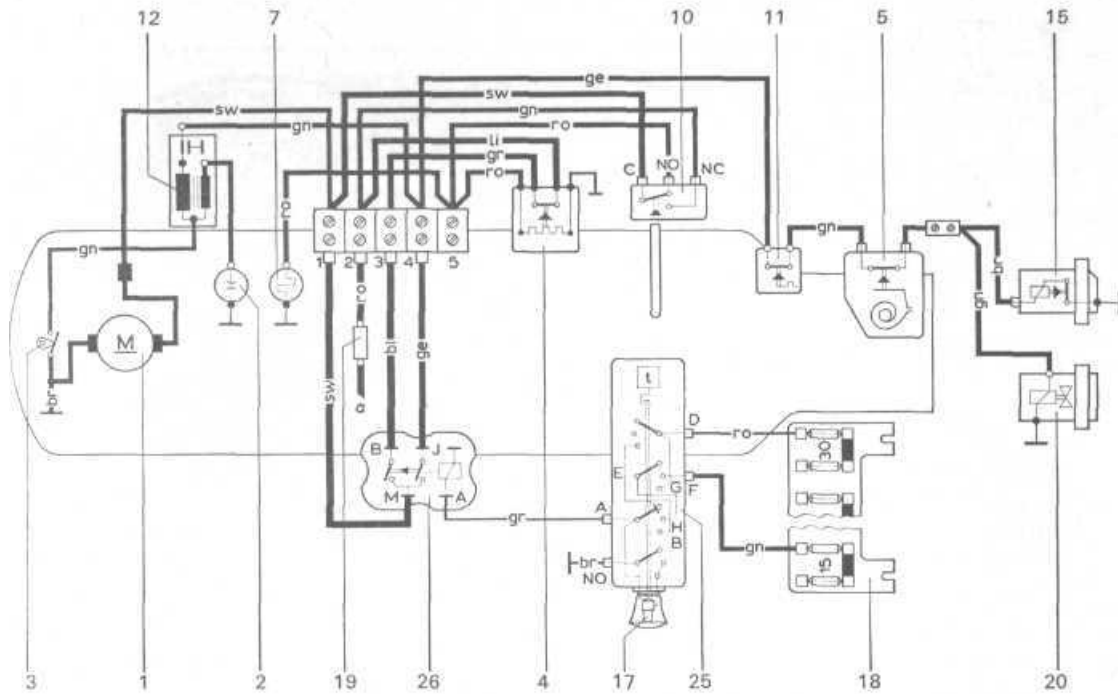
- 13 Glow plug
- 14 Thermo-switch
- 15 Overheating switch
- 16 Safety switch
- 17 Warm air duct
- 18 Control flap
- 19 Temperature regulating switch
- 21 Heater switch
- 22 Warning lamp terminal
- 25 Heat control switch knob
- 31 Exhaust pipe

- 32 Air intake pipe
- 33 Fuel filter
- 34 Suction line
- 35 Pressure line

- A EXHAUST
- B FUEL
- F FRESH AIR
- V COMBUSTION AIR
- W WARM AIR

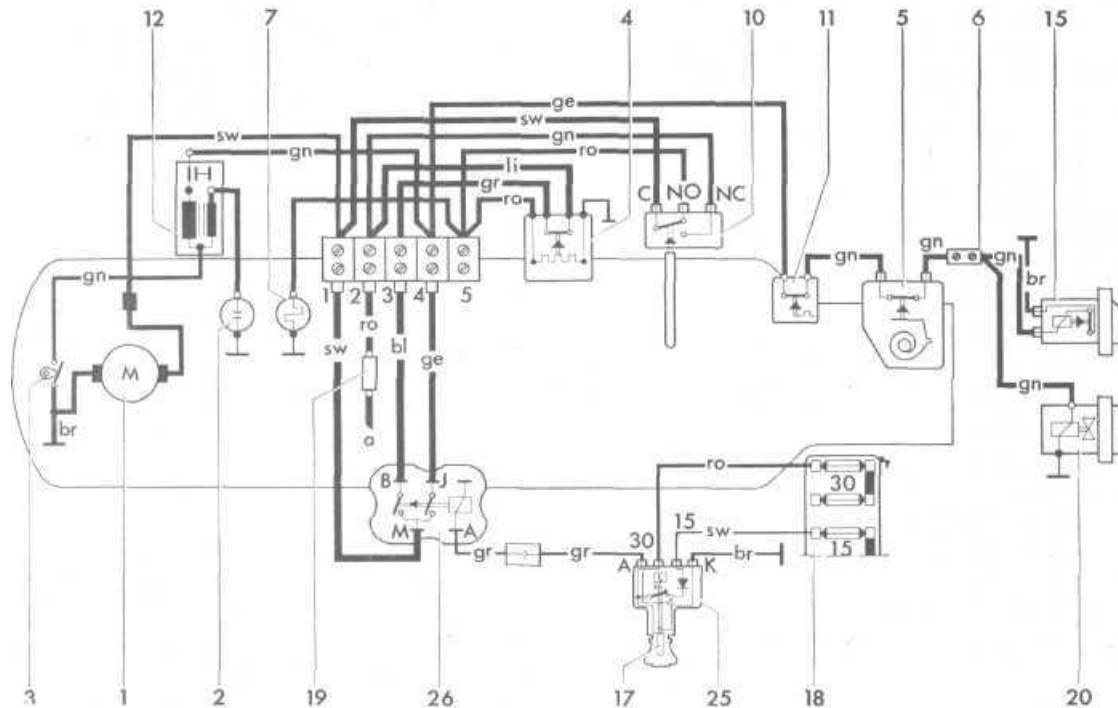






**FIG.2.8 SUPPLEMENTARY HEATER - WIRING DIAGRAMS**  
 (above, to August 1969 - below, from August 1969 to 1973)

- |                                 |                        |                         |             |
|---------------------------------|------------------------|-------------------------|-------------|
| 7 Electric motor                | 11 Overheating switch  | 25 Time switch          | 'ge' yellow |
| 2 Spark plug                    | 17 Ignition coil       | 26 Relay                | 'or' brown  |
| 3 Breaker contact               | 15 Fuel pump           | 'a' To starter terminal | 'gr' grey   |
| 4 Safety switch                 | 17 Warning light       |                         | 'ws' white  |
| 5 Temperature regulating switch | 19 Fuse. 16 amp        | 'ro' red                | 'on' green  |
| 7 Glow plug                     | 20 Fuel solenoid valve | 'sw' black              | 'W' lilac   |
| 10 Thermo switch                |                        |                         |             |



J

# Chapter 3 Fuel system and carburation

*For modifications, and information applicable to later models, see Supplement at end of manual*

## Contents

General description and exhaust emission control ... .. 1	Fuel pump - dismantling, repair and reassembly (early models) ... .. 8
Air cleaner ... .. 2	Fuel tank and fuel gauge sender unit ... .. 9
Solex carburettor - description ... .. 3	Fuel tank - ventilation and activated carbon filter unit ... 10
Solex carburettor - removal, dismantling and replacement ... 4	Throttle valve positioner ... .. 11
Solex carburettors - adjustments ... .. 5	Inlet manifold - removal, inspection and replacement ... 12
Fuel pump - description, checking and filter cleaning ... 6	Faultfinding... .. 13
Fuel pump - removal and replacement ... .. 7	

## Specifications

Fuel pump ... ..	Mechanical, operated from a cam on the distributor drive via a pushrod. 3.5 psi at 3800 rpm 400 cc per minute
Maximum pressure ... ..	
Minimum delivery ... ..	
NOTE: Pumps marked PE 20000 (June '72 onward contain a built in cut off valve)	

Air cleaner ... .. Oil bath type with automatic warm air inlet control

Carburettors ... .. Solax - fixed downdraught

Version	30 PICT 1	30 PICT 2	30 PICT 3	34 PICT 3	
Introduced	1. 8. 67 (not US)	1.8.67	1.8.69	1.6.71	1.8.71
Venturi dia,	24 mm	24	24	26	26
Main jet	120	x116	x112.5	x125	x125
Air correction jet	1352	125Z	140Z	60Z	60Z
Pilot jet	55	55	65	g60	g55
Needle valve dia	1.5 mm	1.5 mm	1.5 mm	1.5 mm	1.5 mm
Floatwtgrms	5.7	8.5	8.5	8.5	8.5
Pump capacity cc/stroke	1.3-1.6	1.3-1.6	1.2 ±.15	1.6 ±.15	1.45 ±.15
Power system jet	50	60	—	95	95
Pilot air drilling	—	—	135	147.5	120
Bypass air cut-off valve	—	—	1.8 mm	—	—
Auxiliary jet	—	—	—	42.5	42.5
Auxiliary air drilling	—	—	—	90	90

### 1 General description

The Volkswagen fuel system is conventional in principle.

A fuel tank is mounted in front of the engine and fuel is fed to the carburettor by a mechanically operated diaphragm pump which is driven by a pushrod actuated by a cam on the distributor drive shaft.

The carburettor is a fixed single choke downdraught type which incorporates a strangler, electrically operated, and an accelerator pump of the diaphragm type. The feed from the accelerator pump can also operate as a subsidiary fuel supply jet under certain conditions. With the automatic choke a diaphragm operated pushrod overrides the choke spring slightly as soon as there is vacuum on the engine side of the throttle flap.

Another device fitted to the carburettor is an electro-magnetic cut-off valve which positively stops fuel from flowing into the inlet manifold. This is necessary because in certain high temperature conditions an over-heated engine can continue running on after the ignition is switched off.

The 1600 series transporter was introduced at a time when emission control was becoming the subject of legal control in many countries. Thus the question of modification arose in an otherwise 'established' engine. Development had to continue during production. The variety of jet sizes and combinations which occurred will be apparent from a look at the specifications and these developments continue as this book goes to press. It is possible that some owners, particularly of the early models which went through a patch of progression (flat spot) difficulties may wish to make modifications in line with the later developments. It is strongly recommended therefore that the full implications of what is involved be first checked out with the VW agents. They will best be able to advise for your particular model.

Pollution of the atmosphere from fumes released by both burnt and unburnt fuel and gases from the internal combustion engine is understandably becoming a topic of international concern. The state of California in the U.S.A. having suffered most, is in the forefront of legislative moves to restrict such emissions to a level which will not render the atmosphere harm-

ful to humans. As the export of VW's to the States is a very significant percentage of their total output, and many seem to get to the West Coast, it is natural that VW activity in the emission control field has been intensive.

As development in this field is still continuing and the rate of official documentation must lag behind physical developments this section can only give an indication of the moves made so far and show the primary areas and methods used to clean up emissions.

These are:

- 1 Burning of the fuel in all engine running conditions to keep unburnt hydrocarbons to a minimum.
- 2 Recirculation of exhaust gas to deal with unacceptable levels of emission dependent on the efficiency of the first stage.
- 3 Recirculation of crankcase fumes into combustion chambers.
- 4 Filtration of petroleum fumes from fuel tanks.

In general items 3 and 4 are the simplest to deal with. All modern cars are now fitted with devices which re-circulate crankcase fumes to the inlet manifold. On the VW there is a flexible pipe from the oil filler neck to the intake duct of the air cleaner for this purpose. The fuel tank is vented through an activated carbon filter unit on most versions.

The fixed choke carburettor as fitted to the VW is much more difficult to modify than the variable choke variety in terms of fuel/air mixture control throughout the full range of engine speeds and load requirements. One of the principle objectives is to weaken the mixture which is always too rich in over-run situations when the throttle is shut. This is the reason for the air by-pass system built into the carburettor which enables more air to be introduced when manifold depression is high and the throttle is closed. Coupled with these carburettor modifications are ignition timing changes which positively retard the spark to aid combustion also under these conditions. The changes over the two year period 1970-1972 have been considerable and have resulted in difficulties because of effects on performance called 'progression' problems - better known as 'flat spots'. Any owner who may not be satisfied with a car's performance should refer to a VW dealer who will be able to advise the most up to date and suitable remedies. Finally there is a cooling coil device that cools part of the exhaust gases themselves and re-circulates them via the combustion chambers. This has a beneficial effect on the resulting exhaust gas emission.

Some versions also have a throttle valve positioner device which serves to further limit the 'choking' effect of a closed throttle on the over run.

With the exception of the exhaust recirculation device, which is not fitted to Transporters powered with the 1600 engine, all other devices are explained individually in this Chapter.

## 2 Air cleaner

The air cleaner serves to filter dust from the air drawn into the carburettor intake, which apart from causing rapid bearing wear would mix with the fuel/air mixture, be heated with the combustion and deposit on or pass through the system. Hard, silica deposits would build up and oil would become contaminated with sludge.

The filter used on the VW Transporter is the oil bath system which means that all intake air is drawn through a quantity of oil first. It then passes through a wire mesh filter element, which retains the oil and any dust, before moving on to the carburettor. It is an efficient and inexpensive method of filtration. Maintenance requirements are confined to washing out and replacing the oil at suitable intervals depending on atmospheric conditions.

Built into the intake side of the air cleaner are hose connections, and flaps for the following purposes. A large flexible hose leads into the lower part of the intake from a duct near to the right hand pair of engine cylinders. When cold, the engine draws air only from around these cylinders as they warm up. The

thermostat control of the main fan (see Cooling system) is linked to a flap in the air cleaner intake and as the engine warms up so the flap opens to admit cool air from the main air intake. Later models have an independent thermostatically controlled flap dependent on the air temperature entering the cleaner (rather than the air temperature around the cylinders) and thus give a more precise control.

A small hose connects the crankcase breather vent (incorporated with the engine oil filler tube) into the lower half of the air cleaner body and recirculates crankcase fumes. All but the earliest models have a further flap, with a counterweight control, which closes off the main air intake of the cleaner at lower engine speeds, thus ensuring that sufficient vacuum is provided to draw the fumes in. As the engine speed increases the flap opens automatically and the venturi low pressure effect of the passing air takes over from the direct engine vacuum.

Checking involves undoing the clips securing the upper and lower halves of the air cleaner body, separating them and seeing that the oil level is up to the indicator mark. This is not normally necessary between services unless there is cause to suspect a leak. When the time for cleaning and replenishing the oil occurs the cleaner should be removed from the engine compartment as a complete unit.

To do this undo the clips securing the two large hoses and pull them off and also the crankcase ventilation hose. Then undo the clips securing the cleaner to a bracket on the right side of the engine compartment and take the unit out, taking care not to tip it and spill oil all over the place.

Keep the cleaner level and upright and take off the top half after undoing the clips (photos). The oil, when at the correct level should be at least 5 mm deep above any accumulations of sludge. Under average conditions the filter should not need attention at less than 6000 mile intervals. In dusty conditions this frequency will increase and only experience will give an indication. If the extreme - such as driving across desert with no hard top road surfaces - is encountered it will be necessary to check daily. If the cleaner is neglected the air intake passages through the cleaner will become restricted resulting in a rich fuel mixture and poor performance.

The mesh element in the top half of the cleaner should be drained and any blockages of the holes cleared.

Do not wash the element in volatile substances as retention of fumes could cause a spit back fire in the element after the cleaner is replaced. Paraffin may be used but it should be blown out with an air jet and the element soaked in fresh oil before replacement. Sludge should be washed out of the base container, the intake pipes wiped clean and the container filled up to the level mark (0.45 litres/0.8 pint) with fresh engine oil. Refit the top section and secure the clips before replacing the cleaner in reverse order of removal. It may be necessary to release the clips again when the cleaner is in position in order to line up the various hose connections exactly.

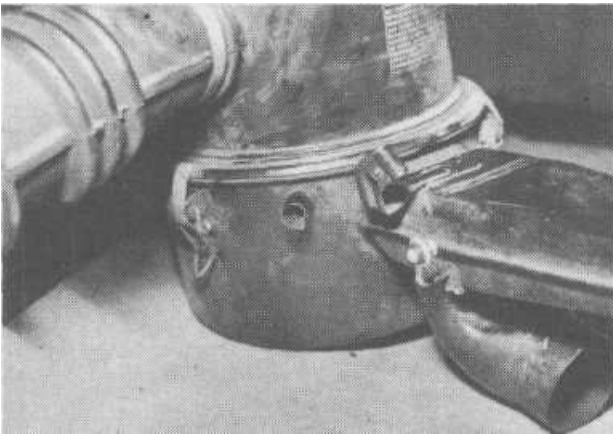
## 3 Solex carburettor - description

The carburettor is basically a tube through which air is drawn into the engine by the action of the pistons and en route fuel is introduced into the air stream in the tube due to the fact that the air pressure is lowered when drawn through the 'tube', A scent spray works on the same principle.

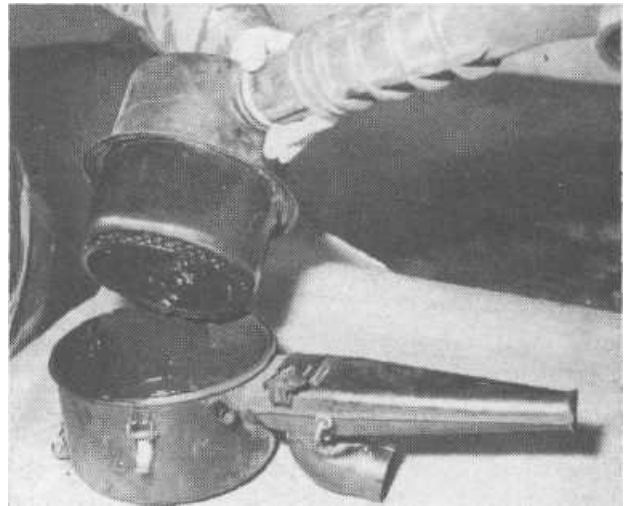
The main fuel discharge point is situated in the 'tube' - choke is the proper name for the tube to be used from now on - between two flaps which can block off the tube. One of these is the throttle flap - operated by the accelerator pedal and positioned at the engine end of the choke tube. The other is the strangler - which is operated by an automatic device.

When the engine is warm and running normally the strangler is wide open and the throttle open partially or fully - the amount of fuel/air mixture being controlled according to the required speed.

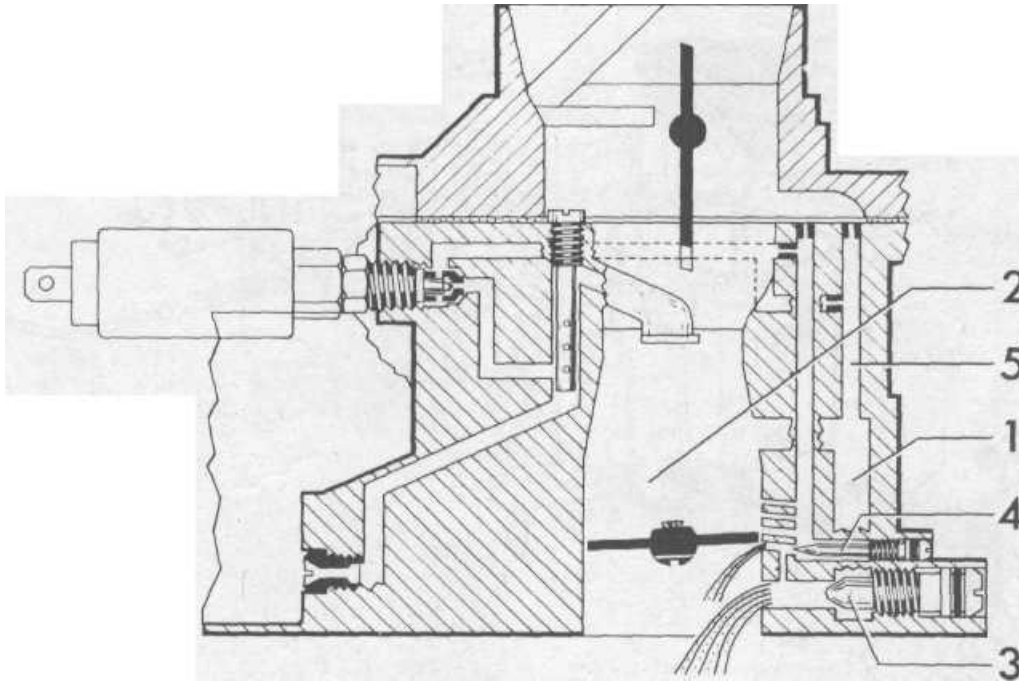
When cold the strangler is closed - partially or fully and the suction therefore draws more fuel and less air, i.e. a richer



2.1a Air cleaner removed from vehicle (keep it this way up)



2.1 b The top half of the air cleaner withdrawn for servicing



**FIG. 3.1. DIAGRAMATIC CROSS SECTION OF SOLEX 30 PICT CARBURETTOR WITH AIR BY PASS ADJUSTMENT**

- |   |                                 |   |            |   |                      |   |                      |
|---|---------------------------------|---|------------|---|----------------------|---|----------------------|
| 1 | By pass air/fuel mixing chamber | 2 | Choke tube | 4 | Volume control screw | 5 | By pass air drilling |
| 3 | By pass air adjustment screw    |   |            |   |                      |   |                      |

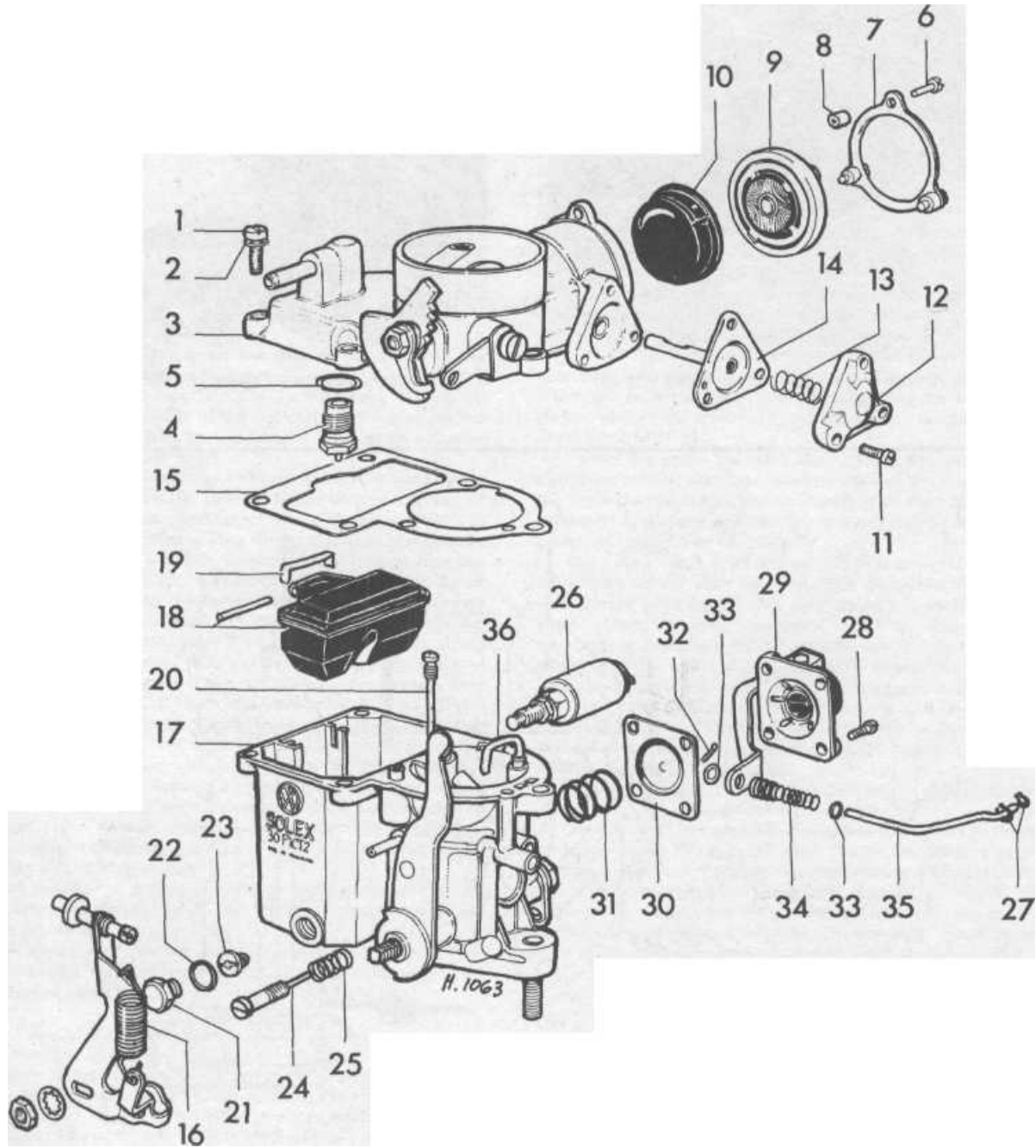


Fig 3.2.A. CARBURETTOR SOLEX 30 PICT/2

- |   |                             |                                  |                                       |
|---|-----------------------------|----------------------------------|---------------------------------------|
| 7 Screw                                 | 10 Cap                      | 19 Float pin bracket             | 28 Screw                              |
| 2 Lockwasher                            | 11 Screw                    | 20 Air correction jet            | 29 Pump cover                         |
| 3 Upper body                            | 12 Cover                    | 21 Main jet plug                 | 30 Pump diaphragm                     |
| 4 Needle valve                          | 13 Spring                   | 22 Washer                        | 31 Spring                             |
| 5 Seal                                  | 14 Vacuum diaphragm         | 23 Main jet                      | 32 Cotter pin                         |
| 6 Screw                                 | 15 Gasket                   | 24 Volume control screw          | 33 Washer                             |
| 7 Retaining ring                        | 16 Accelerator cable spring | 25 Spring                        | 34 Spring for connecting link         |
| 8 Spacer                                | 17 Main body                | 26 Pilot jet & cut off valve 'A' | 35 Connecting link                    |
| 9 Insert with spring and heater element | 18 Float and pin            | 27 Lock ring                     | 36 Injector tube for accelerator pump |



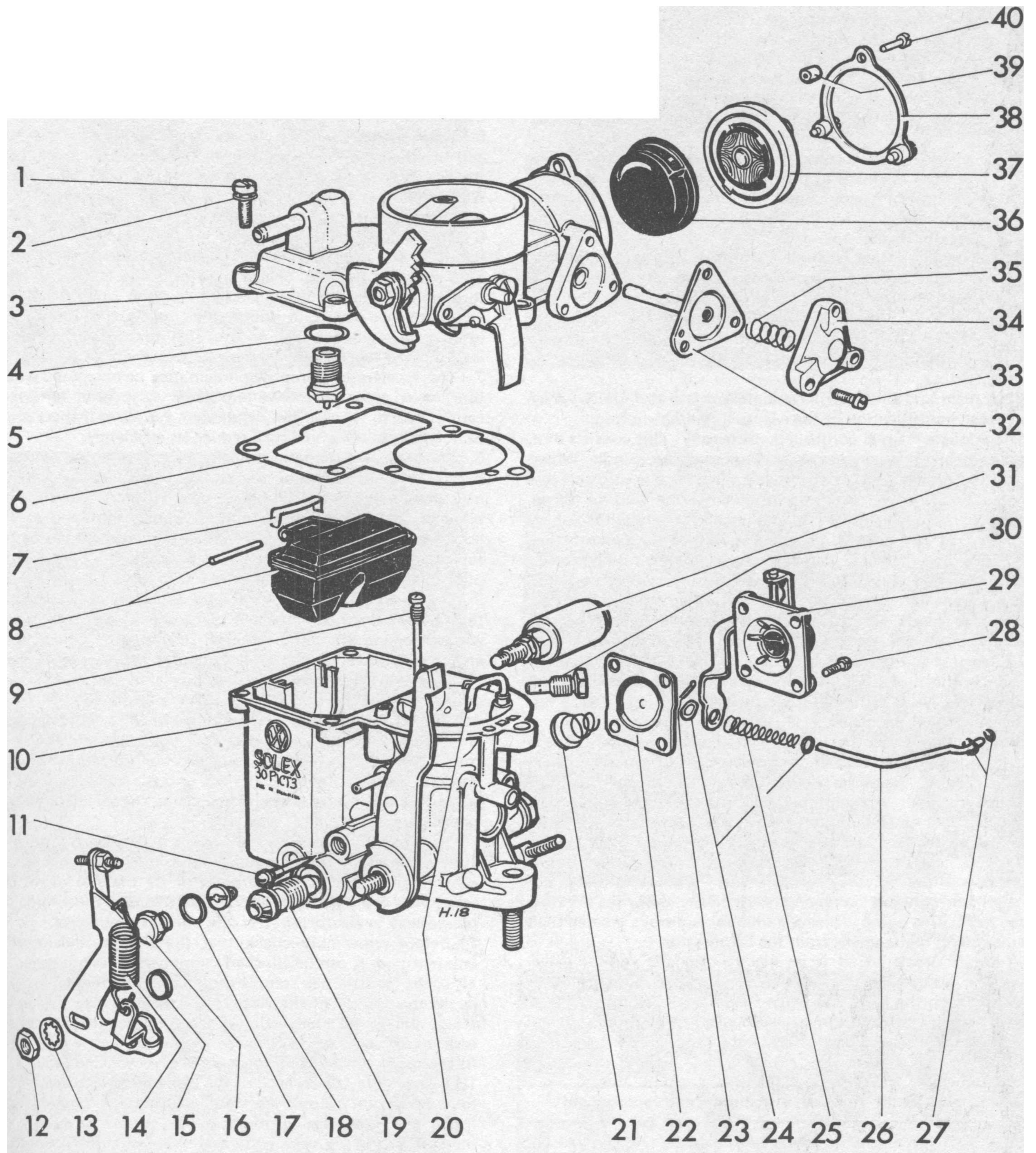


Fig. 3.2B. SOLEX 30 PICT - 3 CARBURETTOR (Sec. 4)

- |                         |  |                          |  |
|-------------------------|--|--------------------------|--|
| 1 Top cover screw       | 12 Nut                                   | diaphragm                | off valve  |
| 2 Spring washer         | 13 Lock washer                           | 22 Pump diaphragm        | 32 Vacuum diaphragm                                  |
| 3 Top cover             | 14 Accelerator cable spring              | 23 Cotter pin            | 33 Screw   |
| 4 Needle valve washer   | 15 Spring washer                         | 24 Washer                | 34 Vacuum diaphragm cover                            |
| 5 Needle valve          | 16 Plug                                  | 25 Connecting rod spring | 35 Vacuum diaphragm spring                           |
| 6 Gasket                | 17 Plug washer                           | 26 Connecting rod        | 36 Plastic cap                                       |
| 7 Float pin retainer    | 18 Main jet                              | 27 Clip                  | 37 Automatic choke with<br>spring and heater element |
| 8 Float                 | 19 Air by pass screw                     | 28 Screw                 | 38 Cover retaining ring                              |
| 9 Air corrector jet     | 20 Injector tube for accelerator<br>pump | 29 Pump cover            | 39 Cover spacer                                      |
| 10 Carburettor body     | 21 Spring for pump                       | 30 Pilot jet             | 40 Retaining ring screw                              |
| 11 Volume control screw |  | 31 By pass mixture cut   |  |



mixture to aid starting a cold engine.

At idling speeds the throttle flap is shut so that no air and fuel can get to the engine in the regular way. For this there are separate routes leading to small holes in the side of the choke tube, on the engine side of the throttle flap. These 'bleed' the requisite amounts of fuel and air to the engine for slow speeds only.

The fuel is held in a separate chamber alongside the choke tube and its level is governed by a float so that it is not too high or low. If too high it would pass into the choke tube without suction. If too low it would only be drawn in at a higher suction than required for proper operation.

The main jet, which is simply an orifice of a particular size through which the fuel passes, is designed to let so much fuel flow at particular conditions of suction (properly called depression) in the choke tube. At idling speed the depression draws fuel from orifices below the throttle which has passed through the main jet and after that a pilot jet to reduce the quantity further.

Both main and pilot jets have air bleed jets also which let in air to assist emulsification of the eventual fuel/air mixture.

The strangler flap is controlled electrically. This consists of a coiled bi-metal strip connected to the choke flap spindle. When the ignition is switched off the coiled metal strip is cold and the flap is shut. When the ignition is switched on current flows through the strip which heats up and uncoils - opening the choke flap after some minutes. If anything should go wrong with this electrical arrangement the flap will return to the closed position.

With the flap closed there are two features which partially open it immediately the engine starts. The flap spindle is offset so one side tends to turn around the spindle under the depression in the choke tube. Also there is a diaphragm valve connected to another rod attached to the flap spindle. Depression in the choke tube also operates this. If these devices did not exist no air at all would get through with the fuel. This would then flood the engine.

Finally there is another device - an accelerator pump. This is directly linked to the accelerator controls. When sudden acceleration is required the pump is operated and delivers neat fuel into the choke tube. This overcomes the time lag that would otherwise occur in waiting for the fuel to be drawn from the main jet. The fuel in the float chamber is regulated at the correct height by a float which operates a needle valve. When the level drops the needle is lowered away from the entry orifice and fuel under pressure from the fuel pump enters. When the level rises the flow is shut off. The pump delivery potential is always greater than the maximum requirement from the carburettor.

Another device fitted is an electro-magnetic cut-off valve. This is a somewhat unhappy feature which is designed to positively stop the fuel flow when the engine is stopped. Otherwise the engine tends to run on - even with the ignition switched off - when the engine is particularly hot.

#### 4 Solex carburettor - removal, dismantling and replacement

1 The carburettor should not be dismantled without reason. Such reasons would be for cleaning or renewal of the float and needle valve assembly and, in rare circumstances, the jets. Partial dismantling would also be necessary for checking and setting the float chamber fuel level. Where statutory exhaust emission control regulations are in force it must be remembered that any disturbance of the carburettor (and ignition) settings may result in unacceptable exhaust gas emission. Such emissions will need checking with the proper equipment.

2 Remove the air cleaner and then detach the accelerator cable from the throttle control lever. Undo the screw which holds the cable end to the link, withdraw the cable and remove the link so that it does not fall out and get lost. Pull off the wire connection clips from the automatic choke and electro-magnetic cut-off valve.

3 Undo the two nuts which hold the carburettor to the inlet manifold and lift the carburettor off (photo). The exterior of the

carburettor should be clean before dismantling proceeds. Exterior deposits can be removed easily with cellulose thinners.

4 The first stage of dismantling should be to remove the screws holding the top to the base. Separate the two halves carefully and remove the paper gasket taking care to keep it from being damaged. It can be re-used (photo).

5 To clean out the float chamber, remove the float pin bracket and the float can then be taken out. Do not under any circumstances strain it in such a way that the pin or bracket are bent. When the float is removed the bowl may be flushed out with petrol and sediment removed with a small brush.

6 The needle valve is screwed into the top cover and when taking it out note the washer mounted underneath it (photo). The simplest way to check this for leaks is to try blowing through it. It should not be possible to do so when the plunger is lightly pushed in. If in doubt, then renew the assembly, as a leaking valve will result in an over-rich mixture with consequent loss of performance and increased fuel consumption.

7 The accelerator pump diaphragm may be examined when the four cover securing screws and cover have been removed. Be careful not to damage the diaphragm. Renew it if there are signs of holes or cracks which may reduce its efficiency.

8 The electric automatic strangler may be removed for cleaning but do not use petrol on the cover. If any part is suspected of malfunction the whole unit must be renewed. When refitting the bi-metal spring the looped end must be positioned so that it hooks over the end of the lever. Then the cover should be turned so that the notch lines up with the notch on the carburettor. Do not overtighten the securing screws.

9 The main jet is situated behind a hexagonal headed plug in the base of the float chamber. This can of course be removed without taking the carburettor off the engine. Remove the plug and then unscrew the jet from behind it with a screwdriver. The pilot jet is fixed similarly in the body alongside the accelerator pump housing. When cleaning these jets do not use anything other than air pressure. Any poking with wire could damage the fine tolerance bores and upset the fuel mixtures. The electro-magnetic cut-off valve may be simply unscrewed from the carburettor body (photo). Do not grip the cylinder when doing so - use a suitable spanner. Never clamp the valve or carburettor body in a vice.

10 The air correction jet and emulsion tube is mounted vertically in the body of the carburettor by the side of the choke tube. This too may be unscrewed for cleaning. Blow through the passageway in the carburettor also when it is removed.

11 Before reassembly check that the float is undamaged and unpunctured. It can be checked by immersion in hot water.

12 If the throttle flap spindle should be very loose in its bearings in the main body of the carburettor then air may leak past and affect the air to fuel ratio of the mixture. In such cases the easiest remedy is a new carburettor. An alternative is to drill and fit bushes to suit but this needs some expertise and time.

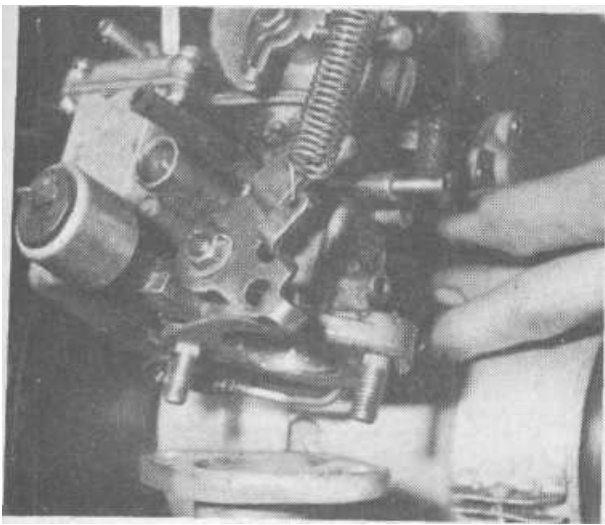
13 Reassembly is a reversal of the dismantling procedure but the following points should be watched carefully (photo). Do not forget the washer when replacing the needle valve. Make sure that the gasket between body and cover is correctly positioned. When refitting the accelerator pump cover, the screws should be tightened with the diaphragm centre pushed in. This means holding the operating lever out whilst the screws are tightened. Do not bend or distort the float arm when replacing it into the float chamber. When reconnecting the accelerator cable take heed of the procedure given at the end of the next section.

14 If a throttle valve positioner is fitted read about the details in Section 11.

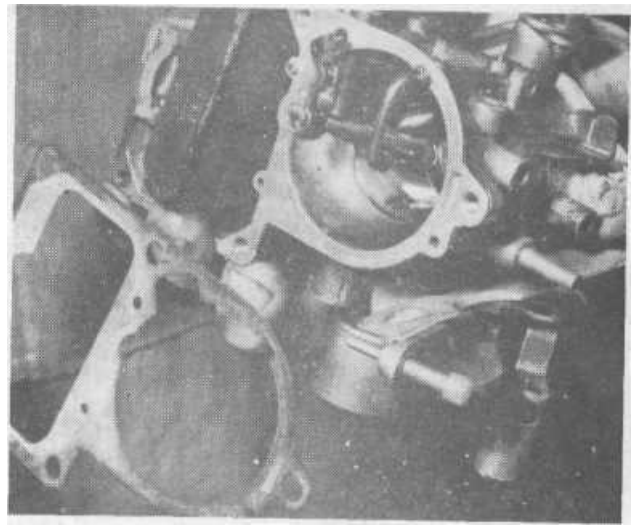
#### 5 Solex carburettors - adjustments

1 Although the various types of Solex PICT carburettor fitted are basically the same in principle, developments since 1967, coupled with pollution control requirements in various countries, means that your vehicle may be fitted with any one of

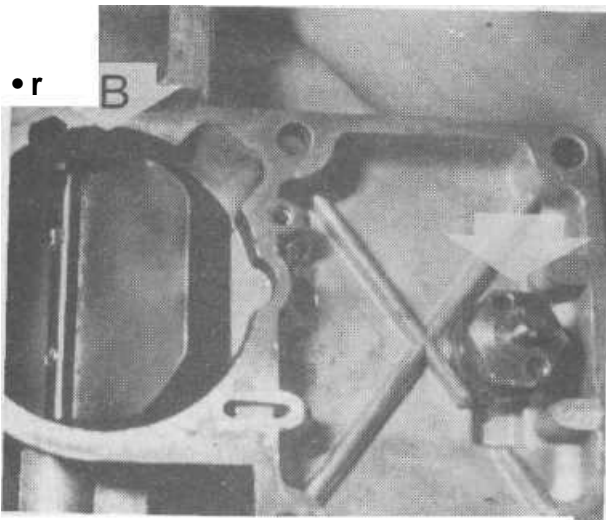




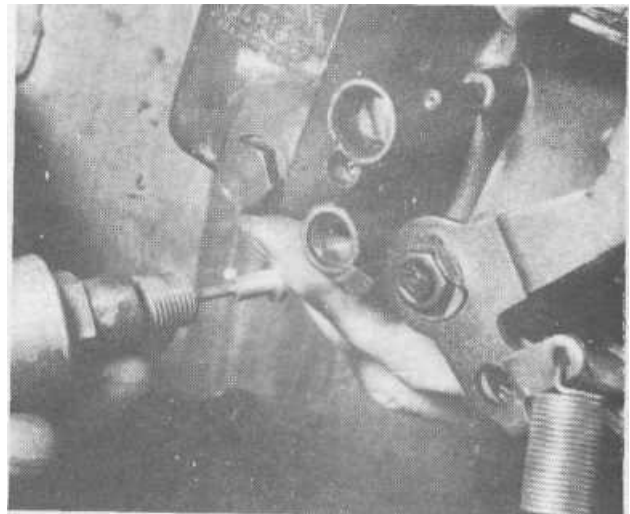
4.3 Lifting the carburettor off the manifold



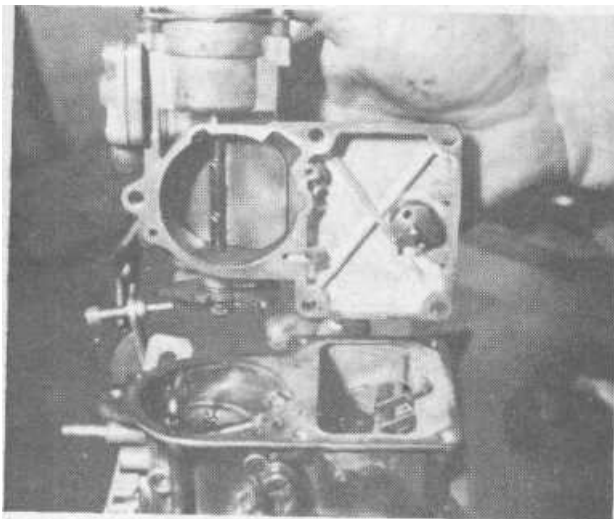
4.4 Lower half of carburettor showing gasket



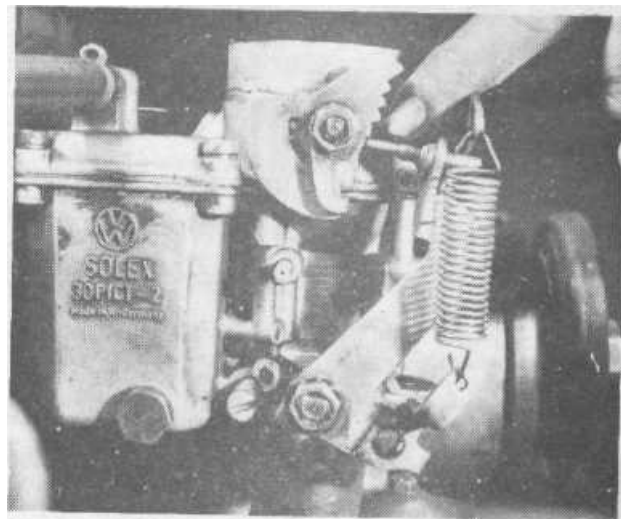
4.6 Upper half of carburettor. Note needle valve and strainer flap B



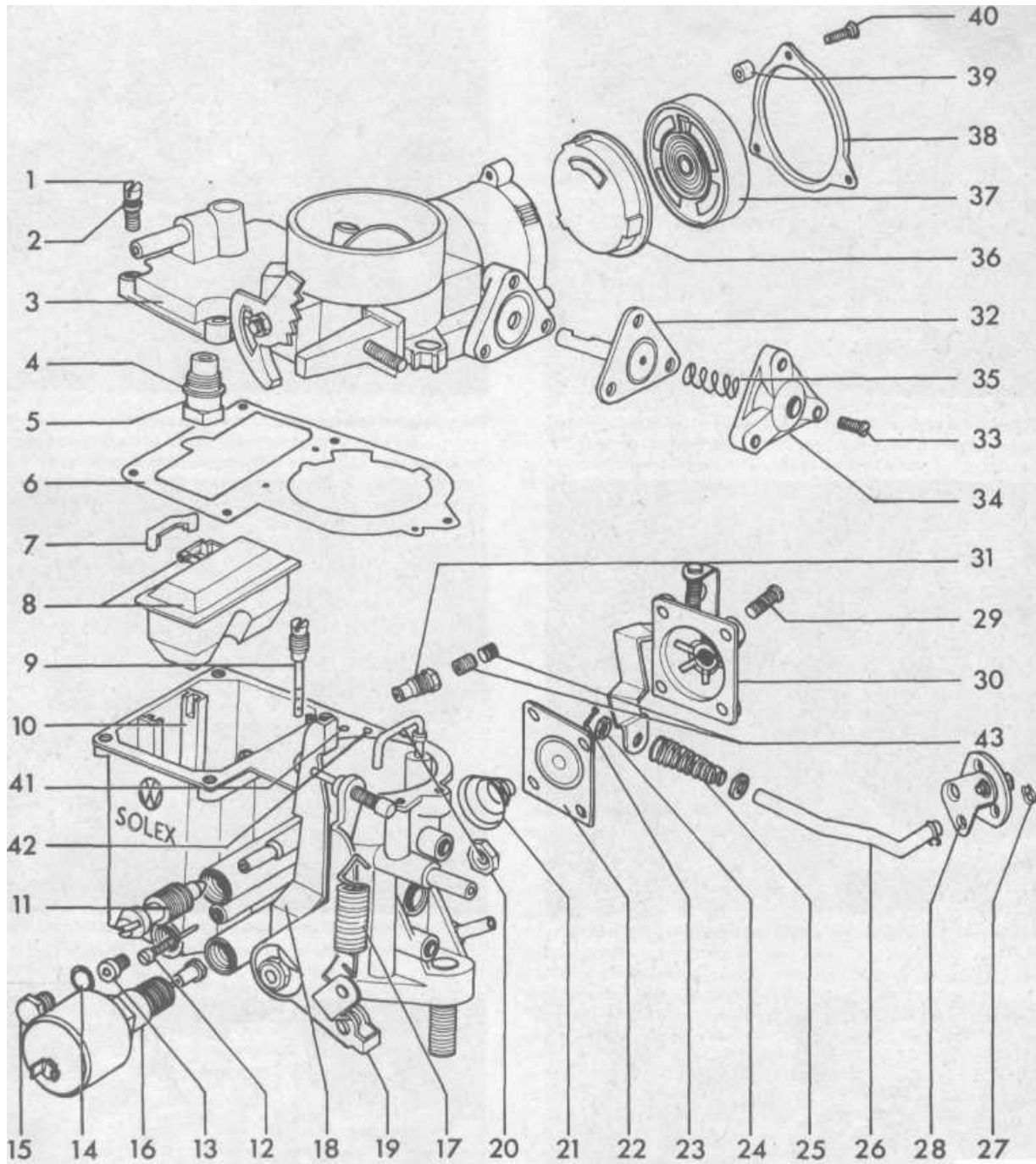
4.9 Electro magnetic fuel cut off valve unscrewed from carburettor body



4.1.3 Reassembling the two halves of the carburettor



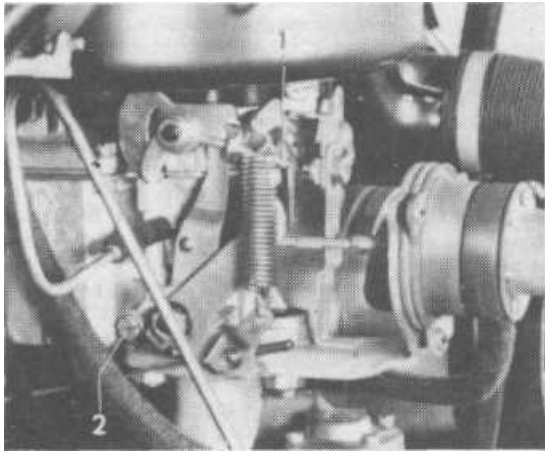
5.5 When the choke flap is fully open the throttle lever stop screw **will** rest at the base position



**Fig.3.2.C. SOLEX 31/34 PICT 3 CARBURETTOR - EXPLODED VIEW**

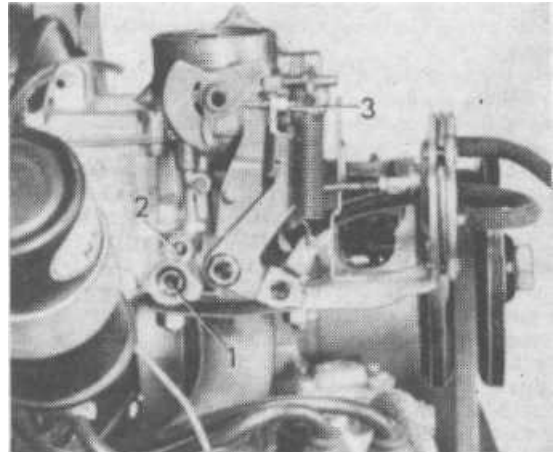
*Difference between the two types is in pilot jet position — angled on the 31 PICT 3 (Sec 3)*

- |  |   |                                  |                                |
|--|---|----------------------------------|--------------------------------|
| 1 Cover screw                          | 12 Idle mixture control screw           | 23 Split pin                     | 35 Spring                      |
| 2 Spring washer                        | 13 Main jet                             | 24 Washer                        | 36 Protection cap              |
| 3 Top cover                            | 14 Washer                               | 25 Spring                        | 37 Heater coil and insert      |
| 4 Needle valve washer                  | 15 Plug                                 | 26 Connecting link               | 38 Retaining ring              |
| 5 Needle valve                         | 16 Electromagnetic cutoff valve         | 27 Circlip                       | 39 Spacer                      |
| 6 Gasket                               | 17 Return spring                        | 28 Bell crank lever (adjustable) | 40 Screw                       |
| 7 Float pin bracket                    | 18 Fast idle lever                      | 29 Countersunk screw             | 41 Pilot air jet               |
| 8 Float and pin                        | 19 Throttle lever                       | 30 Pump cover                    | 42 Auxiliary air jet           |
| 9 Air correction jet and emulsion tube | 20 Injection pipe from accelerator pump | 31 Pilot jet                     | 43 Auxiliary fuel jet and plug |
| 10 Carburettor lower housing           | 21 Diaphragm spring                     | 32 Vacuum diaphragm              |                                |
| 11 By-pass air screw                   | 22 Accelerator pump diaphragm           | 33 Countersunk screw             |                                |
|  |   | 34 Diaphragm cover               |                                |



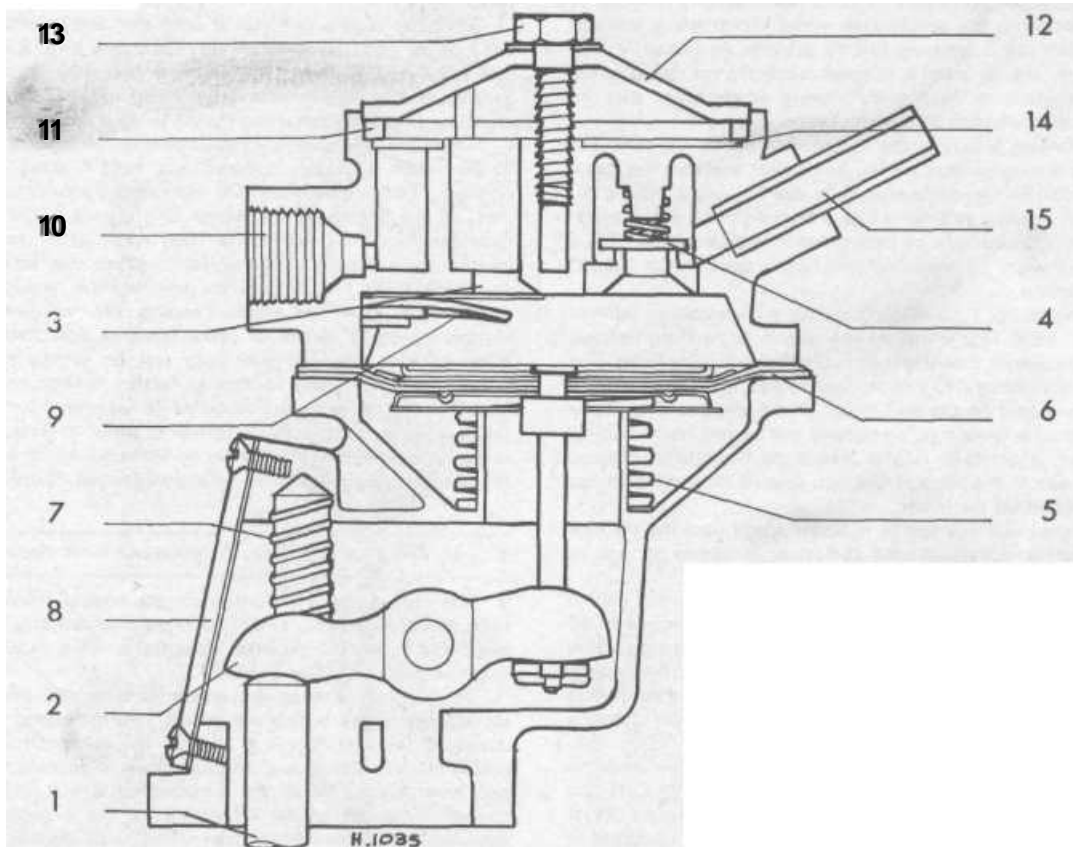
**FIG.3.3 CARBURETTOR ADJUSTMENT POINTS • NOT MODIFIED FOR EXHAUST EMISSION CONTROL REQUIREMENTS (Sec 5)**

- 1 Throttle stop screw
- 2 Volume control screw



**FIG.3.4 CARBURETTOR ADJUSTMENT POINTS - MODIFIED FOR EXHAUST EMISSION CONTROL (Sec 5)**

- 1 Air by pass screw
- 2 Volume control screw (sealed)
- 3 Throttle stop screw (capped)



**FIG.3.5 FUEL PUMP CROSS SECTION (Sec 7)**

- 1 Push rod
- 2 Operating lever
- 3 Petal valve (suction)
- 4 Outlet valve
- 5 Spring for diaphragm
- 6 Diaphragm
- 7 Lever spring
- 8 Cover
- 9 Petal valve retainer
- 10 Fuel inlet
- 11 Top cover gasket
- 12 Top cover
- 13 Cover screw
- 14 Filter screen
- 15 Fuel outlet

five carburettors and none or one of two types of throttle valve positioner. \*

Before attempting any adjustment make sure you know which one you are dealing with.

Throttle valve positioners are described in Section 11, and need adjustment after first setting the carburettor.

Before touching anything else see that the throttle cable is correctly set. If it has been disturbed it is most important that it is correctly set to provide both maximum opening of the throttle and at the same time not cause any strain at the fully open position. An assistant will be needed to do this. First disconnect the throttle lever return spring and move the lever to the fully open position and then come back about 1 mm. With the accelerator pedal on the floor connect the cable into the clamp. This is done in such a way that no tension can ever exist due to the cable trying to pull on a fully open throttle. Then check that the throttle returns to the fully closed position and that the stop screw is set as described later in this section.

2 Carburettor adjustment is different depending on whether your carburettor is a PICT 1, 2 or a 3. \_\_\_\_

The 1 and 2 have two basic adjustment points - the throttle stop screw and the volume control screw. The 3 has both of these and an additional air by pass screw. This latter type has been developed in order to set a minimum richness of the mixture particularly at idle speed and on the over run which is when conventional fixed choke carburettors always run rich. The latest vehicles all have the air by-pass type carburettors fitted regardless of the country they are sold in. See Figs. 3.3 and 3.4.

3 The other adjustable item which is not normally in need of regular attention is the accelerator pump. This device delivers neat fuel into the intake venturi to provide an instantly rich mixture when the throttle is opened suddenly for rapid acceleration. Hesitation or 'flat spots' during acceleration may be caused by maladjustment of the accelerator pump.

4 Before starting to adjust the carburettor for any reason it is important that the ignition timing be correct and that the spark plugs and distributor contact points are in good condition. Otherwise adjustment will merely be a compensating error resulting in a further reduction of performance and economy. If the engine is old, worn or neglected it is hardly possible to 'adjust' its troubles away!

5 To set the earlier type of carburettor, with a volume control screw alone fitted, first warm up the engine to running temperature and make sure that the automatic choke is fully open. The position of the choke flap can be ascertained from the position of the stepped cam on the end of the choke spindle. When fully open the throttle lever stop screw will rest at the base position (photo). Until the choke flap is closed the throttle stop screw will rest on one of the steps of the cam causing the engine to run at a higher speed for warm up.

If the engine will not run at tickover speed turn the throttle lever stop screw clockwise until the speed increases enough to enable the engine to run.

Screw the volume control screw clockwise until the engine speed drops and then turn it back until the highest engine speed possible can be obtained. Then turn the throttle lever stop screw anti-clockwise to reduce the engine to tickover speed (850 rpm). Do not try and set the tickover speed too low. If you do not have a tachometer set tickover down until the generator charging warning light just comes on.

If smooth slow running is still difficult to achieve stop the engine and take the volume control screw right out. If the tapered end is grooved someone has been abusing it by forcing it right into the carburettor and the seat is probably damaged as well. Get a new screw which will certainly improve matters.

6 For later carburettors with the air by-pass screw (Fig. 3.4), the air by-pass screw alone is altered to adjust the idle speed. This is because the throttle lever stop screw and the volume control screw are pre-set when the engine is test run after assembly. These settings are to ensure that the throttle flap is in exactly the correct position in relation to the choke tube when closed and the slow running mixture at the maximum permissible richness for the exhaust emission control requirements.

The mixture screw is recessed in the casting and sealed with a soft metal plug. The end of the throttle lever stop screw should also have a plastic cap to discourage indiscriminate (or accidental!) adjustment.

If variation of the air by-pass screw adjustment does not achieve the desired results, and assuming all other matters (ignition timing etc.) are as they should be, then it may be necessary to alter the volume control screw and/or throttle stop screw. Should the sealing plug or protective cap be missing it is reasonable to assume that someone has already had a go at them before. To reset the throttle stop screw move the choke flap to the fully open position so that the tip of the screw bears on the lowest portion of the fast idle stepped cam on the choke spindle. Then turn the stop screw out until the tip of the screw just does not touch the cam. Then screw it back until it just touches the cam without moving the throttle lever. In this position the throttle flap is fully closed, as it should be. If a throttle valve positioner is fitted then the special intermediate lever, which is also attached to the throttle spindle, should not be touching any part of the carburettor body after the adjustment to the stop screw. If it is, then it could be holding the throttle open. In such instances the valve positioner pull rod should be shortened at this stage and the valve positioner adjusted later after the settings to the carburettor have been made.

With the throttle set closed the stop screw should not be adjusted again.

Carefully screw the volume control screw fully home - using no force which could damage the seat, and then back it off 2% revolutions.

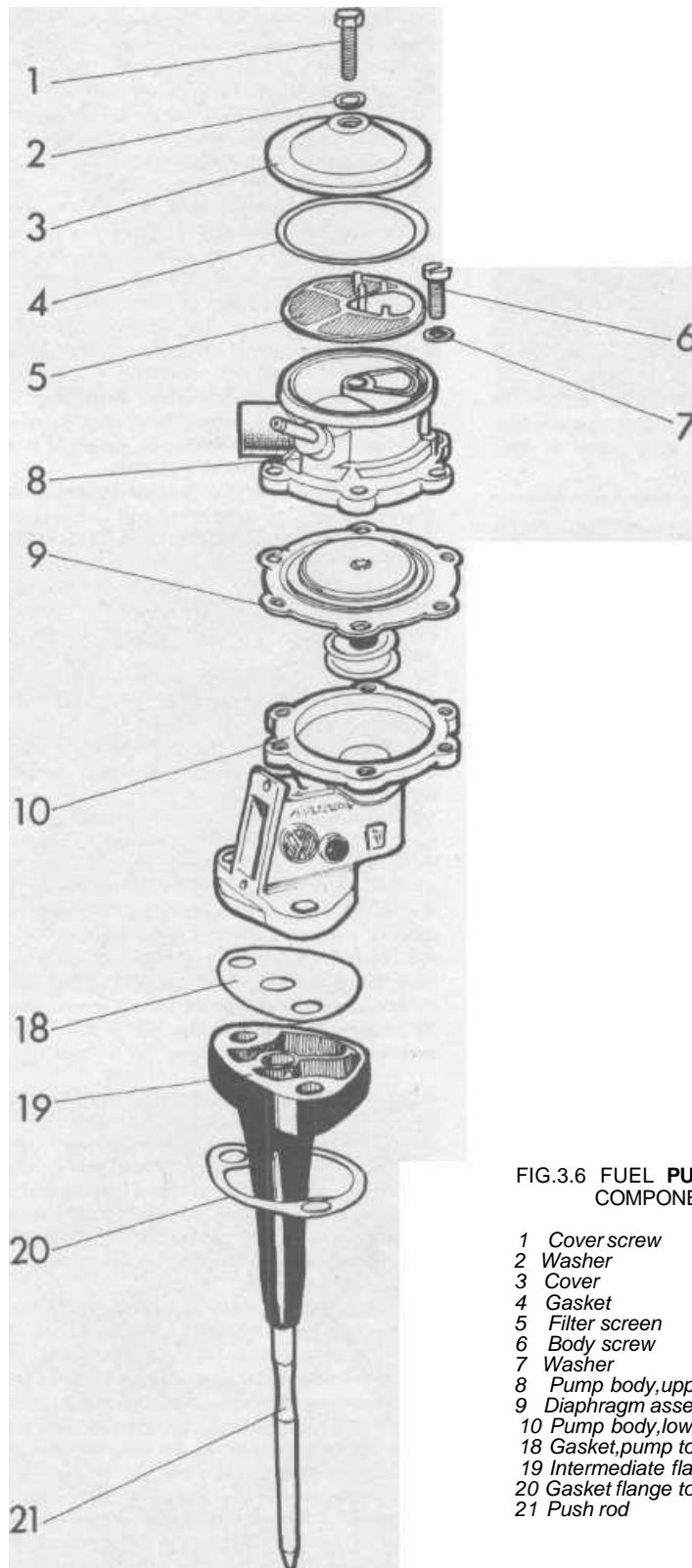
Start the engine and run it until warmed up and the choke fully open. Then turn the air by-pass screw (Fig. 3.4) to get the idle speed of 850 rpm. Then screw in the volume control screw so that engine revolutions drop 20-30 rpm. Then set the idle speed back to 850 rpm using the air by-pass screw only.

Where pollution control regulations are in force it is advisable to have the necessary exhaust gas testing done as soon as possible. It will be seen that the carburettor adjustments are only part of the tuning of the whole engine and if the procedures described here are ineffective then some other area, such as ignition, or valves or inlet manifold leakage may be the cause of any difficulties. The carburettor adjustments, having been made satisfactorily from the engine running point of view, may have compensated for errors in other areas of adjustment. In such instances the exhaust gases may not be within the required limits. The owner may appreciate further that an engine may be 'worn out' from a pollution point of view well before he considers it worn out from a performance point of view. This aspect is not of course confined solely to VW engines. It applies to all those engines equipped with pollution control devices.

## 6 Fuel pump - description, checking and filter cleaning

1 The fuel pump is mounted on the engine crankcase to the right of the distributor and is operated mechanically from underneath by a vertical pushrod actuated from a cam on the distributor drive shaft (see Fig. 3.5).

The fuel is pumped by means of a captive flexible spring loaded diaphragm which draws fuel into the pump when on its down stroke and forces it out to the carburettor under the action of its return spring. The fuel flows in and out through two one way valves. When the carburettor is full the diaphragm cannot move up under its spring so the constantly moving pushrod and rocker merely 'free wheel' until the diaphragm once more moves up to be drawn down again. Early models have pumps which can be dismantled and refitted with a new diaphragm and valves if necessary. Later pumps are pressed together and only the top cover may be removed in order to clean the filter. The early versions of these 'non-repairable' pumps have a separate device alongside connected to the fuel lines which is a cut-off valve to prevent fuel feeding to the carburettor by gravity alone when the engine is not running. Pressure from the fuel pump automatically opens this valve when the engine rotates. On



**FIG.3.6 FUEL PUMP (EARLY TYPE)**  
COMPONENTS (Sec 8)

- 1 Cover screw
- 2 Washer
- 3 Cover
- 4 Gasket
- 5 Filter screen
- 6 Body screw
- 7 Washer
- 8 Pump body, upper
- 9 Diaphragm assembly
- 10 Pump body, lower
- 18 Gasket, pump to flange
- 19 Intermediate flange
- 20 Gasket flange to crankcase
- 21 Push rod

later versions this cut-off valve was incorporated into the body of the pump.

2 To clean the filter screen remove the top cover securing screw and carefully lift off the cover and gasket (photo). The gasket may be re-used provided it remains unbroken.

Carefully hook out the filter screen and blow it through to remove any trapped particles. When replacing the cover see that the gasket is seated correctly and do not overtighten the screw for the cover. If the thread is stripped you may have to get a new pump.

3 If the pump is suspected of not working properly disconnect the flexible pipe from pump to carburettor at the carburettor. Hold the end in a container. Pull the HT lead out of the coil so that the engine will not start and then get someone to turn the engine over on the starter. Fuel should pump out. If nothing happens there may be no fuel delivery from the tank to the pump. Slacken the union on the inlet pipe at the pump. Fuel should flow under gravity from the tank.

If these checks indicate a fault with the pump, remove the pump and check the pushrod as described in the next section. After that the pump will need repair, or in the case of later models, renewal.

## 7 Fuel pump - removal and replacement

1 First disconnect both fuel pipes from the pump. The fuel tank gravity feeds to the pump so the easy way to stop the flow is to clip the flexible connection under the vehicle with a proper tube clamp or a self grip wrench.

2 The two nuts holding the pump to the crankcase should be undone and the pump lifted off (photo). The mounting stud of the carburettor may prevent the pump being lifted clear of its studs so the carburettor must be raised sufficiently to enable the pump to be brought out.

3 Pull out the pushrod and remove the gasket from between the pump and the plastic intermediate flange. It is not necessary to disturb the intermediate flange but if you do, stuff a piece of rag into the crankcase as if anything drops down it could be extremely difficult, if not impossible, to get it out (photo).

4 If you are suffering from persistent fuel pump trouble of one sort or another (starvation of fuel or regularly punctured diaphragms) it is possible that the pushrod is not functioning correctly. Turn the engine until the rod protrudes the maximum amount above the intermediate flange. The normal gasket should be fitted under the intermediate flange. The rod should project 13 mm above the flange. It is possible to vary this by putting more or less gaskets under the intermediate flange. If the rod projects too much the diaphragm will be strained and may be punctured.

5 Before replacement the base of the pump should be packed with grease. The gasket between pump and flange only has one small hole in it for the pushrod. Refit and tighten the nuts. After connecting the fuel lines run the engine to confirm that there are no fuel leaks.

6 On those models fitted with a separate cut off valve it is important to ensure that the fuel lines are fitted correctly. Of the four pipe connections on it the one that is not parallel to the other three is the outlet to the carburettor. The other end of this pipe connects to the outlet (lower) pump connection. The pipe next to the angled pipe is connected to the fuel tank (photo).

## 8 Fuel pump dismantling, repair and reassembly (early models only)

1 Before dismantling a fuel pump with a view to repairing it make sure you can obtain a repair kit - that is a new diaphragm and filters and washers. If not then you are wasting your time and will be better off buying another pump. It may be possible to use a repair kit from another make of pump to cut out another diaphragm but this will be a somewhat expensive repair of a temporary nature.

2 The top part of the pump is a diaphragm valve which is spring loaded to cut off the fuel flow from the tank into the pump.

Otherwise fuel would gravity feed. The valve opens as soon as the engine turns and fuel pressure lifts the diaphragm. At the side of the top section of the pump is a hexagon plug above the fuel inlet pipe. Removal of this plug gives access to the filter screen which can then be cleaned. Do not forget to block the pipe when doing this or fuel may flow out.

If there is no suspected fault in the cut off diaphragm it need not be removed to get to the main diaphragm.

3 After scratching lining up marks unscrew the six screws which hold the two halves of the pump together. The top half can then be lifted off. (Fig. 3.6).

4 In order to remove the diaphragm it is first of all necessary to take out the operating lever pivot pin. This is held by a circlip at each end. First remove the small cover plate and gasket which is held to the lower body by two small screws. Then remove one circlip from the end of the pivot pin and force the pin out.

5 Press the centre of the diaphragm down and the lever can be pulled out. Do not lose the spring.

6 Draw out the diaphragm and spring assembly.

7 Inspect the diaphragm for holes or cracks in the flexible material. The material should be supple, if it is getting brittle and stiff renew the diaphragm assembly.

8 The condition of the two valves should also be checked. One is a petal valve of shim steel and this should lie quite flat. The other is a conventional disc valve which is an assembly staked into position in the top cover. Should either of these be malfunctioning it is easy to renew the petal valve but the other is slightly more difficult. It may be difficult to get the necessary parts also. If you have plenty of time to spare it might be worth waiting for spares.

9 When refitting the diaphragm make sure that the sealing ring fits snugly into its recess in the lower body. Then press the diaphragm down in the centre so that the forks of the operating lever may engage over the toggle at the bottom of the diaphragm pull rod. Still holding the diaphragm replace the pivot pin and refit the circlip.

10 The operating lever return spring can be fitted now. Engage one end on the inner lug in the pump body and snap the other end into position on the lever.

11 When refitting the top half of the pump make sure the inlet and outlet pipes are correctly positioned in relation to the lower half. If you have marked both parts prior to dismantling, this will present no difficulty. Replace all six screws loosely and then press the operating lever to a position which is halfway through its full stroke. Then tighten the six screws alternately and evenly.

12 Repack the base of the pump with a multi-purpose grease such as Castrol LM.

## 9 Fuel tank and fuel gauge sender unit

1 The fuel tank is mounted in front of the engine and to get it out the engine must be removed first (photo). Later models have a detachable bulk head between engine and tank. On pick up models the tank is mounted behind the detachable panels at the back of the side storage locker. These panels both need removal in the first instance.

2 Disconnect the battery.

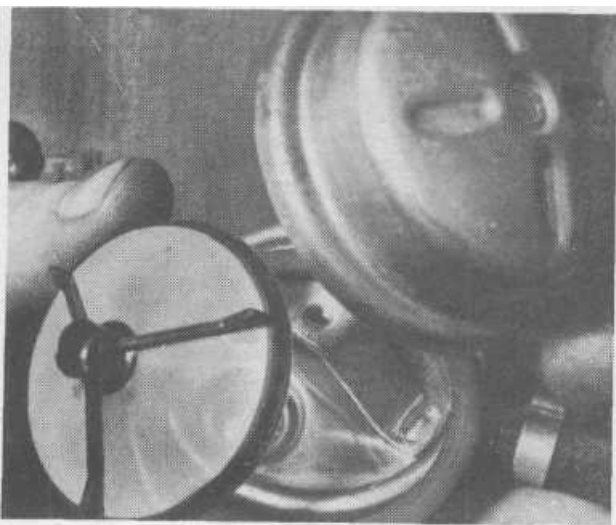
3 The fuel tank should be not more than half full. Then pinch the hose at the tank with a suitable clip. Undo the clip and detach the filler neck hose. Also detach the vent hoses.

4 Disconnect the fuel gauge cable. Undo the securing straps and lift the tank out through the engine compartment.

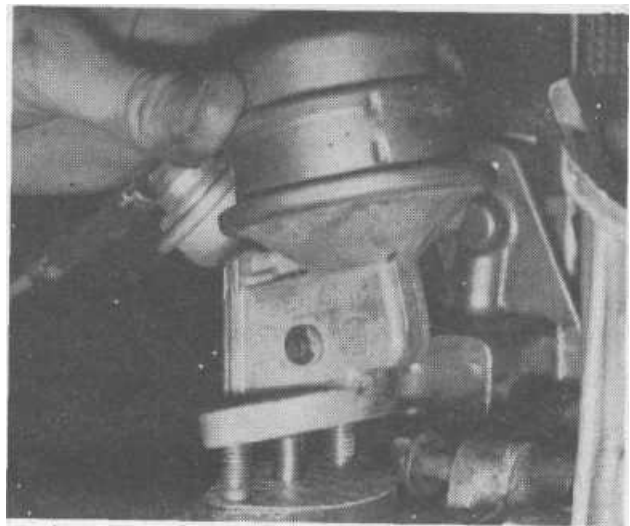
5 If the fuel gauge is not working first detach the lead from the unit on top of the tank (this can be done without removing the tank) and with the ignition switched on touch the lead to earth. If something happens on the gauge then the tank unit must be at fault. To remove this involves taking the tank out unless you cut a hole in the floor pan directly above it. A closure plate and seal are supplied as spare parts.

6 The unit can be drawn out of the tank after undoing the retaining screws. It is not practical to repair it. When fitting a new unit make sure that the adhesive tape is removed from the

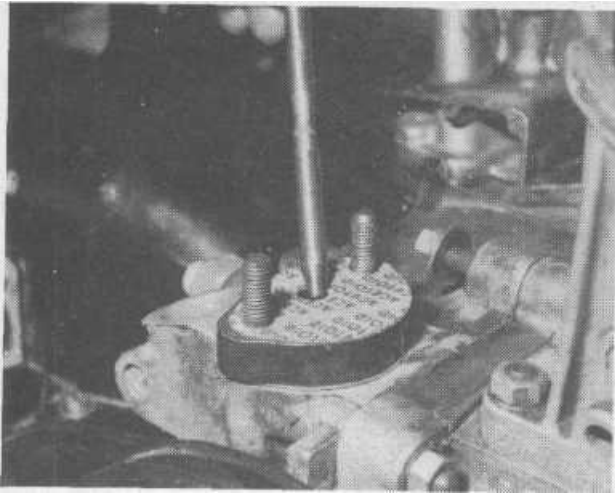




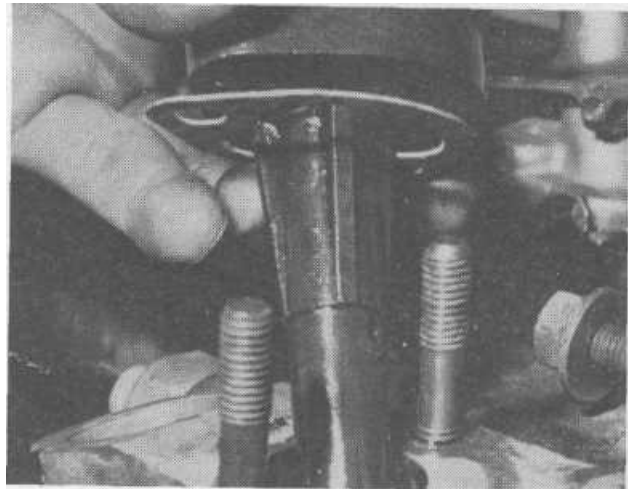
6.2 Removing the fuel pump cover (later types) to clean the filter



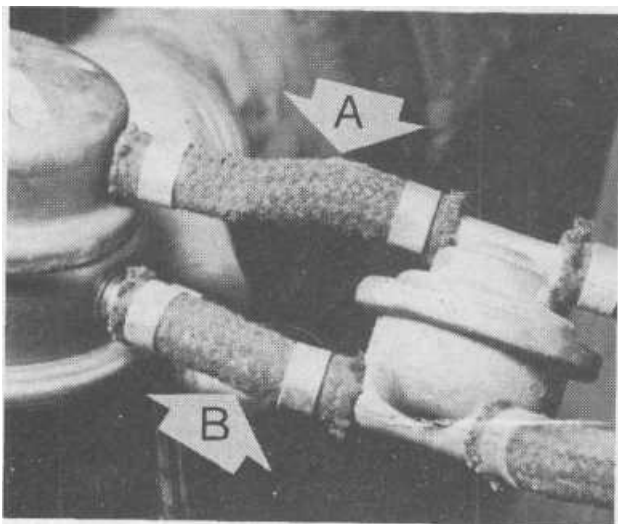
7.2 Removing the fuel pump



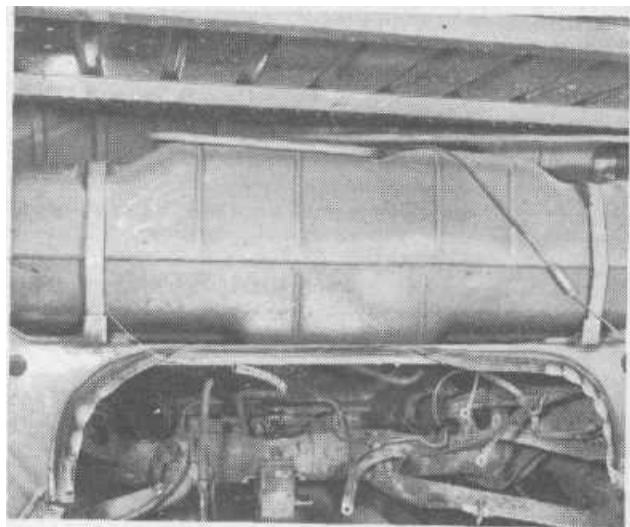
7.3a The fuel pump actuating rod



7.3b The fuel pump intermediate flange



7.6 Fuel pump and external cut off valve connections 'A' from the fuel tank and 'B' to the carburettor



9.1 Fuel tank installation, early models. Later models have a bulk head between the fuel tank and engine.



cylinder and the pin taken out of the cylinder so as to release the float inside.

#### 10 Fuel tank - ventilation and activated carbon filter unit

1 There may be one or more vent pipes on the fuel tank to cope with expansion due to heat and to prevent spillage when the vehicle is parked at, or assumes, unusual angles.

These pipes and rising vent tubes are partially enclosed in the rear vertical body panels on the latest models.

2 Where the market calls for it there is a filter unit of activated carbon which traps hydro carbon fumes evaporating from the petrol. This filter is incorporated in the fuel tank venting system and the container is mounted in the ceiling of the engine compartment at the right. It is automatically "rinsed" when the engine is running, by air which is fed to it from the fan housing. The fumes thus driven from the filter are carried by a hose into the air cleaner where they are fed to the engine (see Fig. 3.7).

#### 11 Throttle valve positioner

1 As part of the exhaust emission control system a throttle valve positioner is fitted which effects the closure of the throttle valve independently of the accelerator pedal. In over-run conditions (where the momentum of the vehicle is driving the engine against a closed throttle) the throttle is prevented from closing completely. This allows more air into the fuel mixture and thus prevents unburnt fuel from a rich mixture being passed through the exhaust to atmosphere. It reduces the effect of engine braking incidentally.

2 Two types of positioner device have been fitted. Prior to August 1969 the unit was in one piece and fitted to the carburettor. After 1969 the device is split into two sections connected by hoses. One part remaining on the carburettor and the other fitted to the side of the engine compartment. The later type incorporates a modification which not only holds the throttle flap open on over-run. It also reduces the speed at which the throttle closes on sudden deceleration. This is done by an additional connection to the carburettor. Engine braking is affected even more noticeably.

3 Operation is quite straightforward. Vacuum from the intake manifold, (which increases on over-run) operates a diaphragm connected to a valve which in turn permits the same vacuum pressure to operate in a second chamber. This affects a second diaphragm which controls mechanically the position of the throttle spindle. The second chamber is open to atmosphere via a restricted drilling. Variations in atmospheric pressure are compensated by an aneroid bellows which varies the preload on the control diaphragm and valve.

4 Adjustment of the unit should be contemplated only after having made sure that the carburettor and ignition are correctly set up. The method of adjustment is different for each type of positioner fitted. For both, make sure that the engine is warmed up to operating temperature and the choke flap fully open. In order to carry out the adjustment correctly it is essential to know the engine speed so a tachometer is required.

5 For the one piece type undo the lock screw and turn the adjuster on the altitude corrector clockwise until the stop washer on the pull rod touches the housing. The engine speed should then be 1700-1800 rpm. If the speed is outside this range then slacken the locknuts on the pull rod and rotate the pull-rod to either shorten or lengthen it. Shorten the rod to increase the engine speed and vice versa.

Then turn the altitude corrector adjuster screw until the engine is back to idle speed of 850 rpm (plus or minus 50 rpm).

Increase engine speed to 3000 rpm on the throttle and then release the throttle. The time taken to regain idle speed should be 3-4 seconds. If necessary, further adjustment of the screw can be made to alter this.

6 The two part version is adjusted by first making sure that the idle speed is correct at 850 rpm ( $\pm$  50 rpm).

When the throttle valve is closed make sure that the intermediate lever (attached to the pull rod) does not contact either the carburettor body or the throttle flap lever. If it does adjust the pull rod as necessary by lengthening or shortening it.

Next pull the intermediate lever back to the stop and adjusting screw on the return spring bracket. At this position the engine speed should be 1700-1800 rpm. Adjust the speed if necessary with the stop screw.

Using the throttle lever, increase engine speed to 3000 rpm. On release the engine speed should drop back to idle in  $3\frac{1}{4}$  -  $4\frac{1}{2}$  seconds. Adjustment for this can be made on the altitude corrector adjusting screw which is in the other part of the unit at the side of the engine compartment.

#### 12 Inlet manifold - removal, inspection and replacement

1 The inlet manifold on the early models was a single piece affair with the attendant pre-heater pipe. On later models the inlet manifold is in three sections. Each outer section fits inside the ends of the centre section and there is a rubber sealing boot over each connection held by hose clips. The outer sections are each twin branch leading to the twin port head.

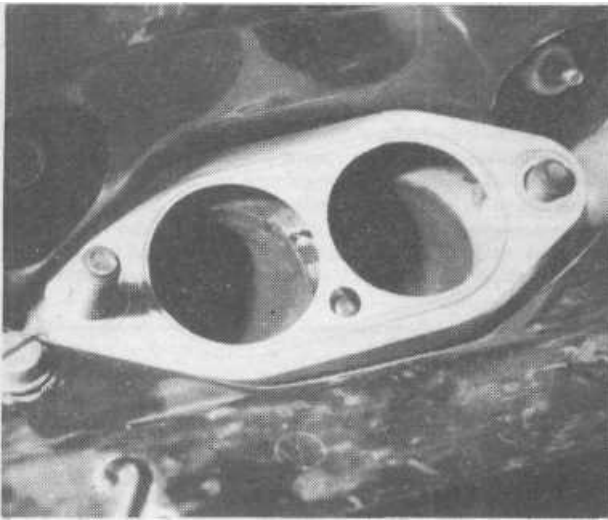
2 It is not practicable to remove the inlet manifold with the engine installed in the vehicle. With the engine out the fan housing or generator pedestal must be removed before the manifold (centre section on later models) can be taken out.

3 It is important that the mating flanges where the manifold joins the cylinder heads are perfectly flat. On the three piece versions the connecting hoses must be free of cracks and the clips perfectly secure. Entry of air at any of these points will upset the engine tune.

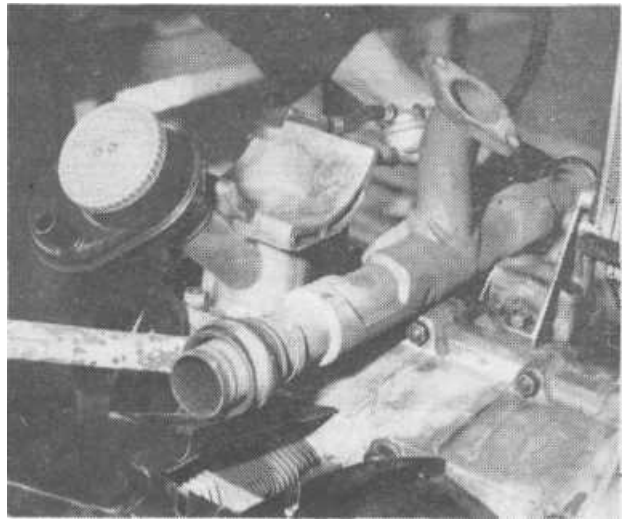
Similarly there must be no distortion or cracks in the manifold castings.

4 When replacing the manifolds always use new gaskets for the cylinder heads (photo). See that the joining surfaces are quite clean. Jointing compound must not be used.

On later models reassemble all three sections loosely at first and get the rubber boots in position over the joints (photo). Tighten down the end sections - taking care not to overtighten and then clamp the centre section. Finally tighten the rubber connector clips (photo).



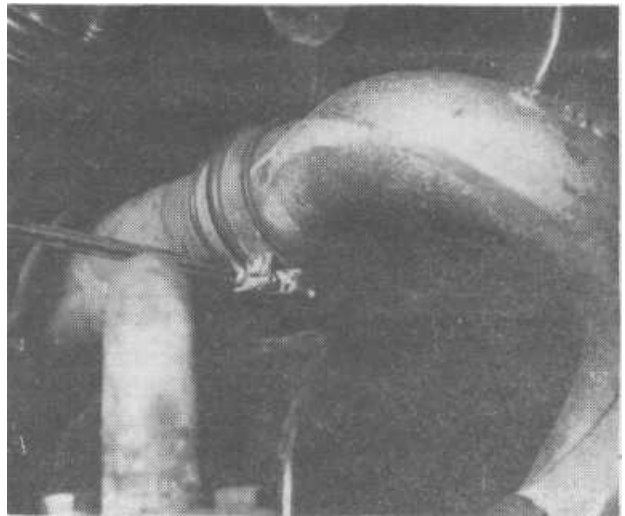
12.4a Inlet manifold aluminium gasket



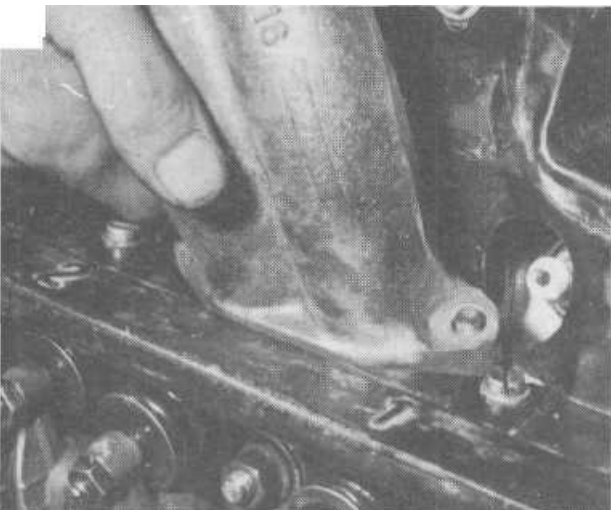
12.4b Inlet manifold centre section being positioned



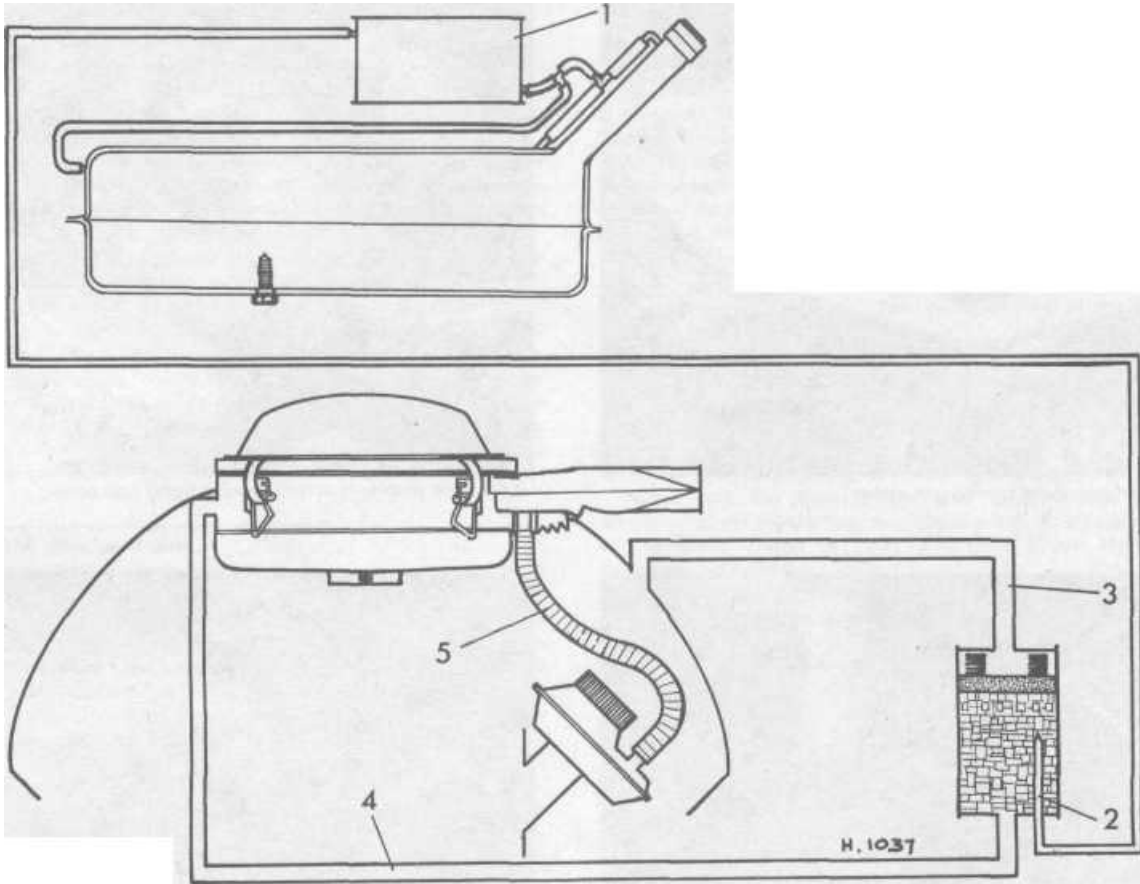
12.4c The sections of the inlet manifold are joined by rubber boots and clips.



12.4d Which must be carefully positioned

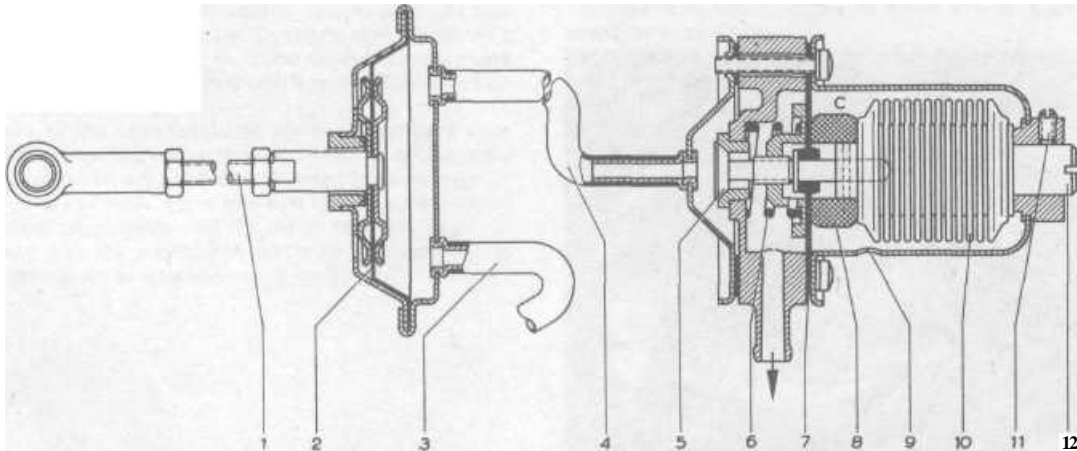


12.4e The manifold outer sections are held by the cylinder head studs



**FIG. 3.7. SCHEMATIC DRAWING OF FUEL TANK VENTILATION WITH ACTIVATED CARBON FILTER UNIT (Sec. 10)**

- 1 Expansion chamber incorporated in fuel tank design)
- 2 Breather line
- 3 Pressure line from fan housing
- 4 Suction line from air cleaner
- 5 Crankcase breather hose



**FIG.3.9 THROTTLE VALVE POSITIONER - TWO PIECE TYPE (Sec 11)**

- |                              |                                    |                        |                       |
|------------------------------|------------------------------------|------------------------|-----------------------|
| 1 Pull rod                   | 4 Vacuum hose from control section | 7 diaphragm            | air vent              |
| 2 Pull rod diaphragm         | 5 Valve                            | 8 Vacuum diaphragm     | 10 Altitude corrector |
| 3 Vacuum hose to carburettor | 6 Spring for vacuum                | 9 Atmospheric pressure | 11 Locking screw      |
|                              |                                    |                        | 12 Adjusting screw    |

## 13 Fault diagnosis

In addition to the more basic faults which may occur in any vehicle fuel system there are some peculiarities as a result in the changes and modifications needed in connection with exhaust emission control - which were made to the carburettor as described in the Chapter. Under certain climatic or altitude situations 'flat spot' problems may occur. Provided these are not caused by basic mistuning or inlet manifold leaks, there is a procedure to be adopted which may call for changing of certain of the carburettor jets. These procedures vary according to the time at which any particular engine was built and can only be comprehensively dealt with by VW dealers.

Before acting on the fuel system it is necessary to check the ignition first. Even though a fault may lie in the fuel system it will be difficult to trace unless the ignition is correct. The table below therefore, assumes that the ignition system is in order.

Symptom	Reason/s	Remedy
Smell of petrol when engine is stopped	Leaking fuel lines or unions Leaking fuel tank	Repair or renew as necessary. Fill fuel tank to capacity and examine carefully at seams, unions, filler pipe and vent pipe connections.
Smell of petrol when engine is idling	Leaking fuel line unions between pump and carburettor Overflow of fuel from float chamber due to wrong level setting or ineffective needle valve or punctured float	Check line and unions and tighten or repair. Check fuel level setting and condition of float and needle valve and renew if necessary.
Excessive fuel consumption for reasons not covered by leaks or float chamber faults	<b>Worn jets</b> Sticking strangler flap	Renew jets. Check correct movement of strangler flap.
Difficult starting, uneven running, lack of power, cutting out	One or more jets blocked or restricted  Float chamber fuel level too low due to needle valve sticking Fuel pump not delivering sufficient fuel  Intake manifold gaskets leaking, or manifold fractured	Dismantle and clean out float chamber and jets. Dismantle and check float and needle valve. Check pump delivery and clean or repair as required. Check tightness of mounting nuts and inspect manifold connections.

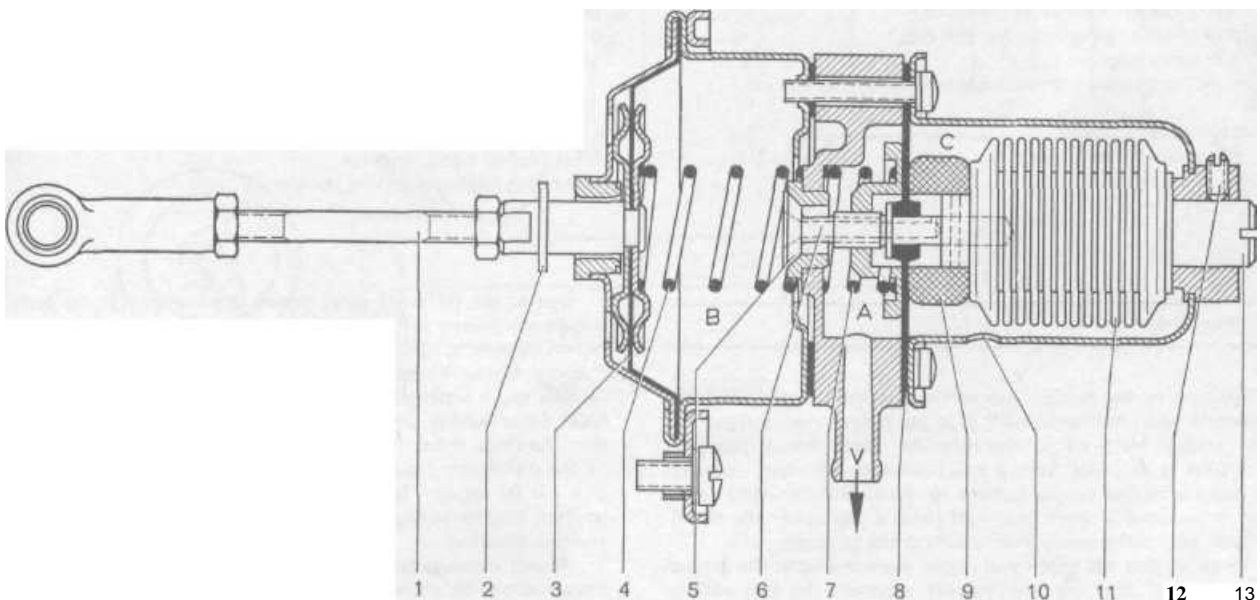


FIG.3.8 THROTTLE VALVE POSITIONER - ONE PIECE TYPE (Sec 11)

- |                       |                     |                         |                        |
|-----------------------|---------------------|-------------------------|------------------------|
| 1 Pull rod            | diaphragm           | diaphragm               | air vent               |
| 2 Stop washer         | 5 Valve             | 8 Vacuum diaphragm      | 11 Altitude correction |
| 3 Pull rod diaphragm  | 6 Air vent drilling | 9 Filter                | 12 Lock screw          |
| 4 Spring for pull rod | 7 Spring for vacuum | 10 Atmospheric pressure | 13 Adjusting screw     |

# Chapter 4 Ignition system

For information applicable to later models, see Supplement at end of manual

## Contents

General description	1	Ignition timing and distributor drive shaft	6
Contact points - adjustment, removal and replacement	2	Spark plugs and HT leads	7
Distributor - removal and replacement	3	Coil	8
Condenser - testing and renewal	4	Fault finding	9
Distributor - inspection and repair	5		

## Specifications

### Spark plugs

Type	Ambient temperature
	Up to 77°F (25°C)
	Above 77°F (25°C)
	Bosch W145T1,
	Bosch W175 TI or
	Beru 145/14 or
	Beru 175/14
	Champion L88A
Electrode gap...	0.7 mm (0.028 in)

### Distributor

Type	12 volt <b>113</b> 905 205 series
Firing order	1 4 3 2
Contact points gap	.4 mm/.016 ins
Dwell angle	<b>44</b> to 50°

### Coil

Type	12 volt <b>311</b> 905 115 A
------	------------------------------

### Ignition timing

- 'B' series engines
- 'AD' series engines to No 290 640
- 'AD' series engines from No 290 **641**
- 'AE' series engines
- Set at idling speed with vacuum hose of distributor off.

**0° \***  
 5° ATDC  
 7A° BTDC  
 5° ATDC

### Timing marks

- 'B' series engines
  - All other series
- 0° is the left notch of three  
 one notch indicates setting position

## 1 General description

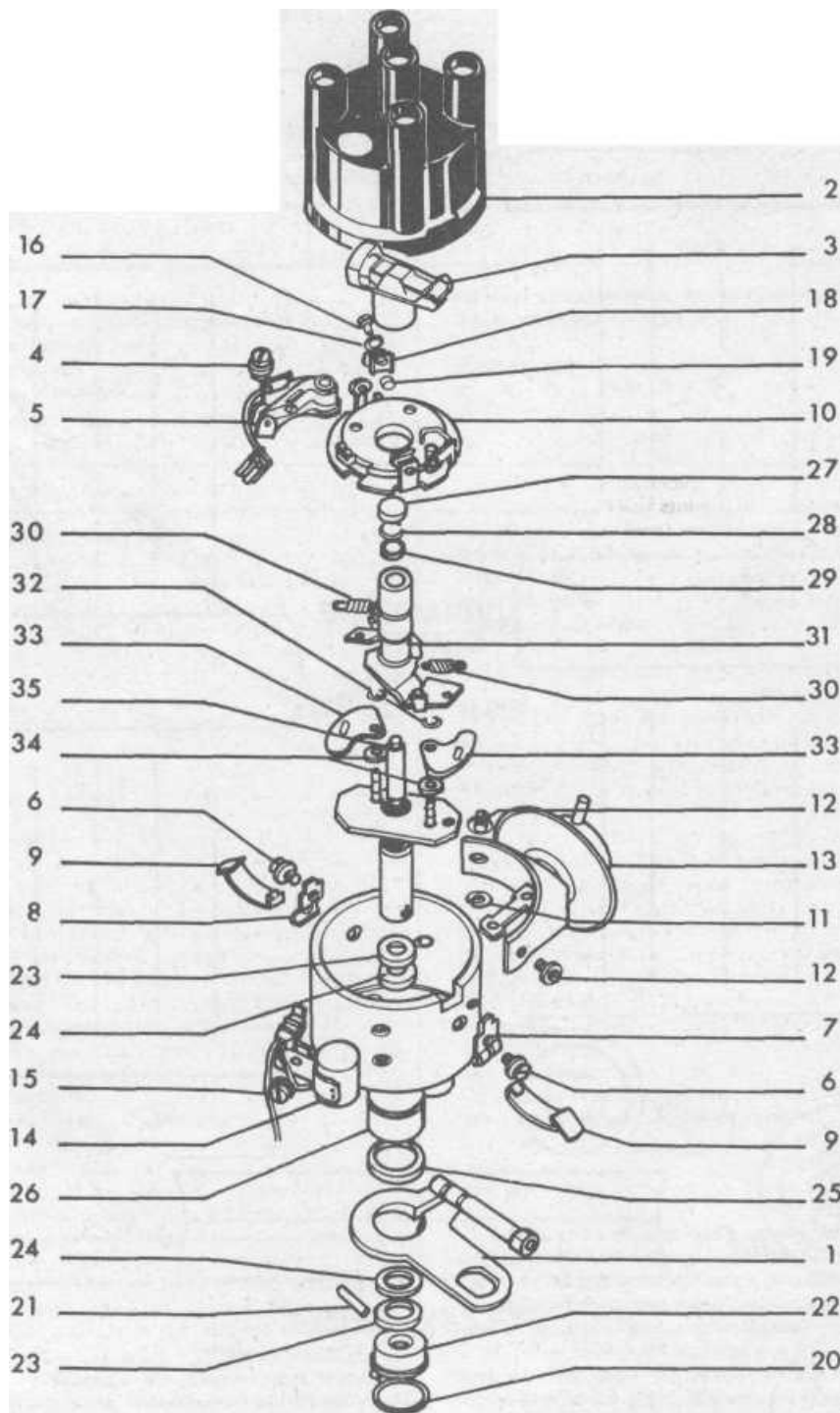
Ignition of the fuel/air mixture in the Volkswagen engine is conventional in that one spark plug per cylinder is used and the high voltage required to produce the spark across the plug electrodes is supplied from a coil (transformer) which converts the volts from the supply battery to the several thousand necessary to produce a spark that will jump a gap under the conditions of heat and pressure that obtain in the cylinder.

In order that the spark will occur at each plug in the correct order and at precisely the correct moment the low voltage current is built up (into the condenser) and abruptly discharged through the coil when the circuit is broken by the interrupter switch (contact points). This break in the low voltage circuit, and the simultaneous high voltage impulse generated from the coil, is directed through the selector switch (rotor arm) to one of four leads which connect to the spark plugs. The condenser, contact points and rotor arm are all contained in and operated at the distributor.

Due to the different spark timing requirements under certain engine conditions (of varying speed or load) the distributor also has an automatic advance device (advancing the spark means that it comes earlier in relation to the piston position).

The spark timing is altered by two methods. One is by centrifugal force acting on bob-weights attached to the distributor cam. As these move out so the cam position is altered in relation to the distributor shaft. The second method - in addition to the first - is by vacuum from the induction manifold. Engine speed governs the centrifugal advance. Throttle opening governs the vacuum advance.

Recent developments in the field of exhaust emission control have resulted in changes in carburettor design. The traditional methods of setting up and tuning the engine are somewhat changed also and it is important to understand that the settings of both carburettor and ignition timing are even more interdependent than they were before. Previously if one or the other was fractionally adrift no serious symptoms were apparent. This is not now the case and flat spots, poor performance and excessive fuel consumption can result if everything is not spot-on.



**FIG.4.2 DISTRIBUTOR WITH CENTRIFUGAL AND VACUUM ADVANCE EXPLODED VIEW : (Sec 5)**

- |                           |                                  |                     |                  |
|---------------------------|----------------------------------|---------------------|------------------|
| 1 Mounting clamp bracket  | 10 Contact points mounting plate | 18 Retaining spring | 27 Felt washer   |
| 2 Cap                     | 11 'E' clip for pull rod         | 19 Ball             | 28 Circlip       |
| 3 Rotor                   | 12 Screw                         | 20 Circlip          | 29 Thrust ring   |
| 4 Contacts securing screw | 13 Vacuum rod                    | 21 Pin              | 30 Return spring |
| 5 Contact points          | 14 Condenser                     | 22 Driving dog      | 31 Cam           |
| 6 Clip screw              | 15 Screw                         | 23 Shim             | 32 Circlip       |
| 7 Clip retainer           | 16 Screw                         | 24 Fibre washer     | 33 Bob weights   |
| a Clip retainer           | 17 Spring washer                 | 25 'O' sealing ring | 34 Washer        |
| 9 Cap clip                |                                  | 26 Distributor body | 35 Drive shaft   |

## 2 Contact points - adjustment, removal and replacement

1 Volkswagen service procedures check the contact points by measuring the cam dwell with special equipment. All else being equal the correct cam dwell gives a points gap of .4 mm/.016 ins. To check the gap, first remove the distributor cap by undoing the two retaining clips, and pull off the rotor arm (photos).

2 Push back the moving contact point against the spring just enough to see whether the surfaces of both contacts are clean and flat. If dirty clean them with a piece of dry clean cloth. If one contact has a peak and the other a pit, it will be impossible to set them with a feeler gauge and they should be removed (as described later on) for renewal or temporary renovation until a new set can be obtained.

3 Having established that the contact faces are clean and flat turn the engine (use a spanner on the crankshaft pulley nut) or engage a gear and rock the vehicle as necessary, until the cam follower on the spring contact is resting on the highest point of one of the four cam lobes (photo).

4 Place a feeler gauge of the correct thickness in the points gap and if it is either tight or slack the points need adjustment. To do this slacken the screw holding the fixed point on to the mounting plate (photo). Then use the screwdriver blade in the notch to lever the fixed point plate either way. It is best not to have the screw too loose when doing this. The feeler blade should slide between the two contacts, touching both but not forcing them apart.

5 When set, tighten the securing screw and check the gap again to ensure the gap has not altered.

6 Replace the rotor arm and distributor cap.

7 If the points have to be removed take out the securing screw completely. Pull off the wire at the single terminal connector clip. The points assembly complete may then be lifted off the pivot post (photo). Although it is not necessary, it is as well to understand the circuitry of the contact points, otherwise the fault tracing procedures described later are somewhat meaningless. The fixed contact is the earth side, so it is mounted, and in contact with the distributor body itself via the base plate. The moving contact is the 'live' side and when assembled it must be insulated from earth. The current travels from the LT wire on the coil to the spring arm to the contact or condenser. The spring contact (and the wires connected to it) must be insulated from the distributor. Similarly the pivot point of the spring contact must be insulated from earth. If this is borne in mind there should be no problem. When finally assembled the two contact points surfaces should line up.

8 The points may be removed completely by removing the adjusting clamp screw and disconnecting the lead at the connection. The whole assembly lifts out.

9 If the points are being cleaned it is best to separate the two pieces of the assembly.

10 To clean up the faces of the contacts use a very fine oil stone. Stone the two faces flat ensuring particularly that the 'peak' is completely removed. If the pit in the other contact is very deep do not try and grind it right out. The points can be adjusted once the peak is removed. Make a note to get a new set at the earliest opportunity.

11 Reassemble the two halves if separated and replace the assembly over the pivot post. Put back the securing screw but do not fully tighten it down.

12 Reconnect the wires at the connector blade terminal.

13 Having re-adjusted the gap on one cam lobe it is advisable to check it on the other three also. Also check that there is no sideways play in the distributor shaft which could cause gap variations.

14 On modern engines, setting the points gap with a feeler blade must be regarded as a basic adjustment. For optimum performance, the dwell angle must be checked and adjusted. The dwell angle is the number of degrees (see Specification) through which the distributor cam turns during the period between the moments of closure and opening of the contact breaker points. The angle can be checked with a dwell meter

connected in accordance with the maker's instructions. If the dwell angle is not as specified and is too large, increase the points gap. If the angle is too small, reduce the points gap.

## 3 Distributor - removal and replacement

1 The distributor should be removed only if indications are such that it needs renewal or overhaul.

2 Take off the distributor cap and pull the LT wire which runs to the coil off the coil terminal. Detach the pipes which fit to the vacuum advance unit.

3 The distributor is held in position by a clamp which grips the lower circular part of the body. The clamp itself is held to the crankcase by a single bolt. If the bolt is removed the distributor and clamp together may be lifted out of the crankcase.

4 It must be realised that if the bolt which secures the clamp to the distributor is slackened - and the relative positions of distributor and clamp altered - then the static ignition timing is upset.

5 The lower end of the distributor drive shaft has a driving dog with offset engagement lugs. These engage into corresponding slots in the distributor drive shaft. Being offset it ensures that the shaft cannot be inadvertently set 180° out of position when the distributor is replaced.

6 It is a good idea to renew the rubber 'O' ring in the annular exterior groove of the body if possible. This seal prevents oil from creeping up on the outside.

7 Replacement of the distributor is a reversal of the removal procedure. See that the offset drive shaft dogs are correctly aligned otherwise they will not engage and the body will not go fully home.

## 4 Condenser - testing and renewal

1 The condenser or capacitor as it is sometimes called, functions as a storage unit for the low tension current which flows into it when the points are closed. When the points open it discharges and sends a boost through the LT circuit to the coil. If the condenser does not function correctly the current shorts to earth across the contact points. This causes arcing and rapid deterioration of the points and also causes the spark producing properties of the coil to malfunction or cease entirely. If, therefore, persistent misfiring and/or severe burning and pitting of the contact points occurs, the condenser is suspect and should be tested right away.

2 To make a simple check on the condenser remove the distributor cap and turn the engine until the contact points are closed. Then switch on the ignition and push open the points with something non-metallic. If there is a considerable spark then this confirms that the condenser is faulty. Normally there should be a very mild spark - almost invisible - across the points.

3 The condenser is mounted on the outside of the distributor and is easily removed and replaced (together with the wires and connectors) by undoing the securing screw.

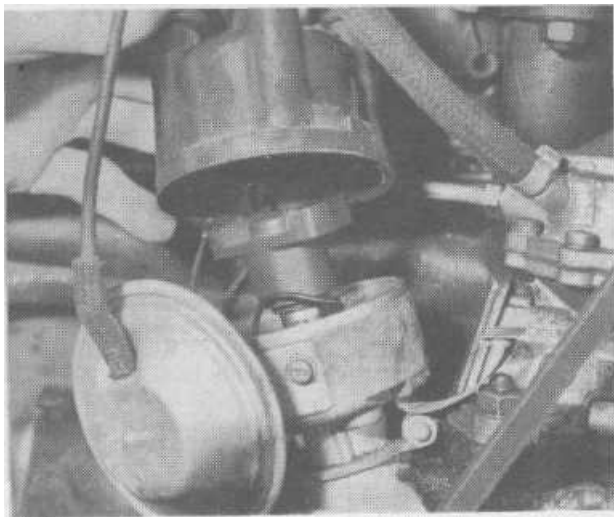
## 5 Distributor - inspection and repair

1 Provided the component parts are kept in good order there should be little need to take the distributor apart except in cases of neglect or very high mileages. One of the indications is when the measured gap of the contact points is difficult or impossible to set accurately and consistently. This is due to wear of the shaft or shaft bushes or, more rarely, wear on the cams. When the shaft or bushes are worn the movement can be felt when sideways rocking pressure is applied to the top of the shaft.

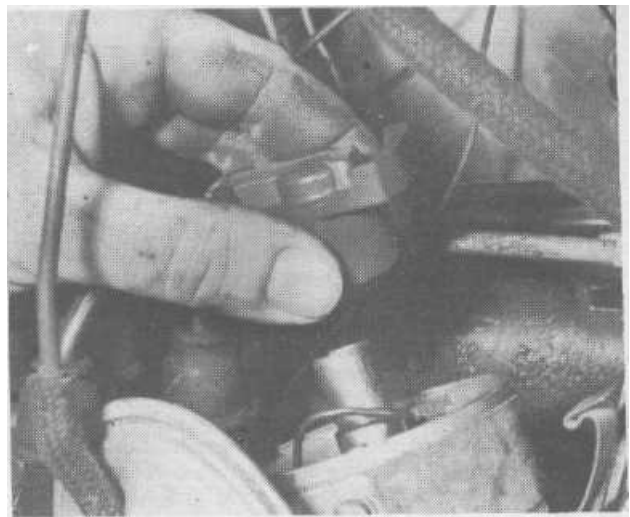
2 In either case the only solution is to remove the distributor and renew the shaft. Alternatively one may find it simpler to renew the whole assembly. Check first that you can obtain the parts you may need.

3 Having removed the distributor, take out the contact points

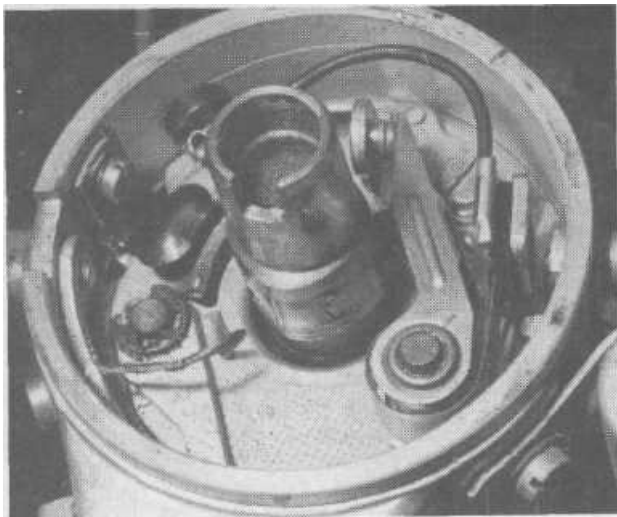




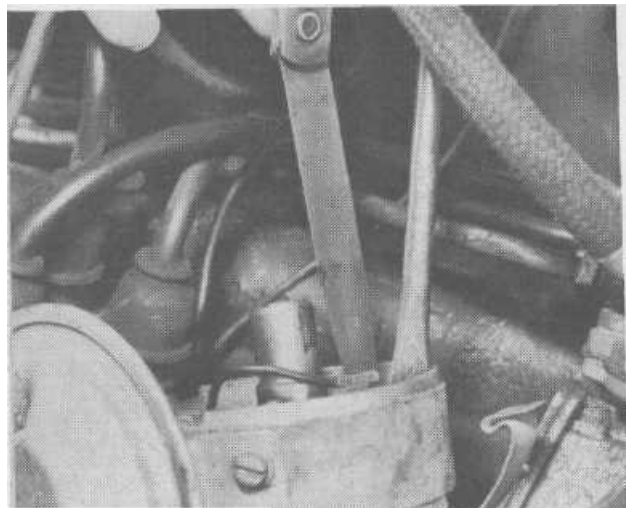
2.1a Removing the distributor cap....



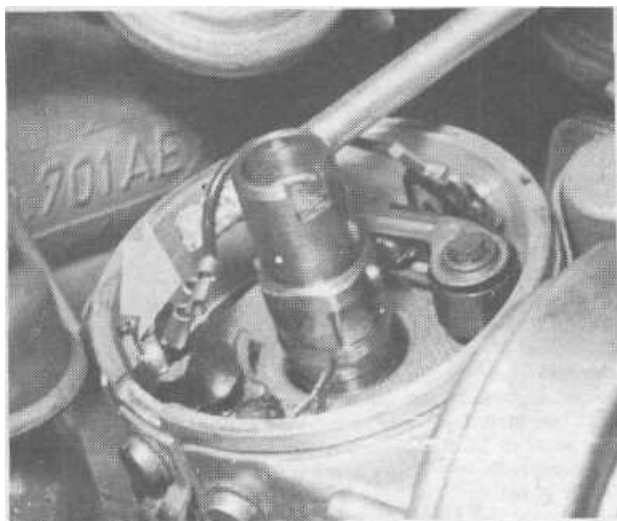
2.1b. ...and rotor



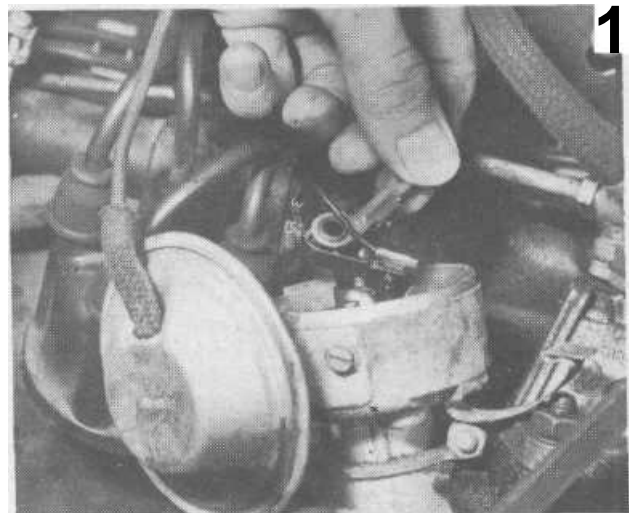
2.3 Contact points ready for gap check



2.4 Checking the points gap with a feeler blade and undoing the clamp screw to enable the fixed point to be moved



2.5 Disconnecting the points lead



2.7 Lifting the points assembly from the pivot post

as described earlier.

4 The next job is to remove the driving collar from the bottom of the shaft but before doing this it is important to note which way it is fitted. See which way the driving dogs are offset in relation to the rotor arm notch in the top of the shaft. The notch and the offset of the dogs should face the same way.

5 When the relative position is noted clamp the collar in a vice and punch out the retaining pin. The collar may then be drawn off the shaft followed by the shims which control the endfloat of the shaft in the body.

6 Carefully unhook the pull rod from the vacuum unit to the contact breaker mounting plate and after removing the screws take off the vacuum unit. Then remove the mounting plate and shaft taking note of the position of the thrust washers.

7 If the shaft is obviously badly worn it must be renewed, but before buying a new one it is essential to check that the bushes in the distributor are not also worn. If they are, then the whole distributor should be renewed as it is not practicable to fit new bushes in the existing body.

8 In any case if the shaft and bushes are worn out it is almost certain that the springs and anchor posts of the centrifugal advance mechanism are equally tired so you might just as well replace the lot.

9 Do not wash the bushes in paraffin or other solvent and make sure they are well lubricated before reassembly.

10 New distributor shafts when in position may need a variation in the thickness of the shims fitted between the driving dog and the body.

11 Reassembly is a reversal of the dismantling procedure. Make sure the driving dog is fitted the correct way round and when the pin is fitted peen the ends so that it cannot drop out.

## 6 Ignition timing and distributor drive shaft

1 In the description section of this Chapter it was pointed out that the ignition timing and carburettor setting was a little more critical than on earlier models. It is possible to set the engine up by the well tried method of adjustment and road testing to obtain the best performance. It is a good idea when this method is used to get hold of someone experienced who has some idea of what the idling speed (800-900 rpm) sounds like. Provided the carburettor is set correctly to start with (Chapter 3) progressive setting changes at the distributor will achieve the desired results. If you can obtain a strobe light and a tachometer for temporary hook up you will save a lot of time. You will also be sure that the settings are spot on first time. The main point to remember is that having set it all up stationary and being delighted when the engine starts first time there will almost certainly be further adjustments necessary. If the pull away through the gears seems a bit 'flat' nudge the distributor more to advance (anticlockwise). If the engine fluffs a bit in the lower revolutions and then zooms away as the revs increase then back it off a little.

These tips are given here because the setting procedures given in the following paragraphs are precise - only when they have been done should you carry out any final 'sweetening'. There should be little need to alter the timing except in cases of engine overhaul, distributor overhaul or when the points are changed.

2 If the timing has to be reset from scratch the distributor should be removed first so that the distributor drive shaft position may be verified and set as required.

3 The distributor drive shaft may be removed and installed with the engine assembled and in the car provided that the distributor, fuel pump and fuel pump intermediate flange have first been removed. (The distributor drive shaft also drives the fuel pump pushrod from a face cam incorporated on the shaft). If the engine is being reassembled after overhaul the drive shaft should be refitted after the oil pump, lower cover plate and crankshaft pulley have been refitted.

4 To withdraw the drive shaft from the crankcase first set No. 1 cylinder to firing position. This is done by setting the correct mark on the pulley wheel to the crankcase joint. The offset slot in the top of the shaft should then be parallel with and towards

the pulley wheel. Remove the spacer spring. Before starting to lift the shaft out it must be understood that there are thrust washers underneath the lower end and with the engine installed in the car there are dangers of these being irretrievably moved out of position. In any case they can only be lifted out with a narrow magnet on the end of a stick (if the engine is installed). So - don't take out the drive shaft unnecessarily and if you do have to don't disturb the thrust washers underneath. The shaft may now be lifted up and out, rotating anticlockwise as it is lifted. The main problem is getting hold of it. If you do not have the special tool there are a variety of ways namely: jamming a piece of suitably sized wooden dowel into the centre hole, gripping the sides of the hole with a pair of long nosed expanding circlip pliers, jamming a piece of thin wooden batten into the slot.

5 If the thrust washers are removed for some reason they should be replaced by dropping them down over a suitable guide rod so that they lie flat and central in the bottom of the shaft housing bore (photo).

6 The engine should be set at the firing point for No. 1 cylinder, when the shaft is to be replaced. The firing point is when the appropriate notch on the pulley is set in line with the crankcase joint with No. 1 piston on the compression stroke.

7 To find the compression stroke with the distributor drive shaft removed is not easy because there are no reference points. The only sure way is to remove No. 1 spark plug and turn the engine until compression is felt when the timing marks come into line. It is easy to feel the compression by placing a finger over the plug hole. If the right hand rocker cover is removed the compression stroke can also be pinpointed when both valves are closed.

8 The distributor drive shaft should now be lowered into the crankcase with the offset slot positioned slightly anticlockwise from its final correct position as detailed in paragraph 4 (photo). When it is lowered into mesh with the crankshaft worm gear it will turn slightly clockwise to the final correct position. Replace the thrust spring (photo).

9 With the engine and distributor drive shaft set and not moved from the position as described in the preceding paragraph the distributor may be placed in position with the shaft lined up so that the eccentric dogs engage the eccentric slots. Provided the clamp has been undisturbed no further adjustment is necessary after the clamp securing bolt has been replaced and tightened.

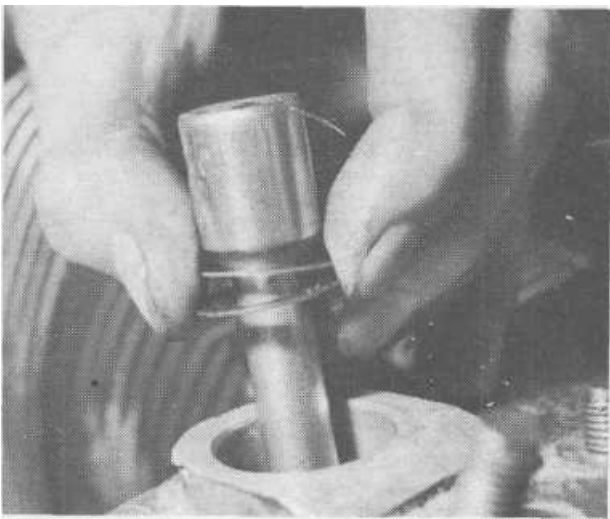
10 If the clamp ring has been slackened the body of the distributor should be turned so that the centre line of the rotor arm electrode matches up with the notch in the edge of the distributor body. This gives the near correct position. Final adjustment is made after the contact points have been checked and the gap set. With the crankshaft at the No. 1 firing position the contact points should just be opening. To do this the distributor body should be first turned clockwise a fraction from the setting mark until the points are shut. The body is then turned anticlockwise until they are just open.

To gauge accurately when the points open connect a 12 volt bulb between the 1" terminal on the coil (the one from which the wire goes to the distributor) and earth. Switch on the ignition and when the points open the bulb should light.

11 From now on the ignition timing is set with the engine running at idling speed (800-900 rpm). The basic settings of the carburettor are checked as described in Chapter 3 and the engine is started, warmed up and set to run at the correct idling speed by using the by-pass air screw (or throttle stop screw on early models) on the carburettor. Then stop the engine again.

12 Connect the strobe light into No. 1 HT lead on the distributor cap. See also that the V notch in the crankshaft pulley wheel is clean and visible (paint it white if necessary). Start the engine again and shine the strobe light onto the pulley. The notch should line up with the crankcase joint. If it does not, slacken the distributor clamp and turn the body of the distributor one way or the other until it does. It is not necessary to tighten the distributor clamp each time an adjustment is made provided the distributor is held reasonably tight.

13 When an adjustment is made it is likely that the engine idling



6.5 Fitting the distributor drive shaft thrust washer over a suitable guide rod



6.8a Replacing the distributor drive shaft. Note the fuel pump drive cam on the shaft

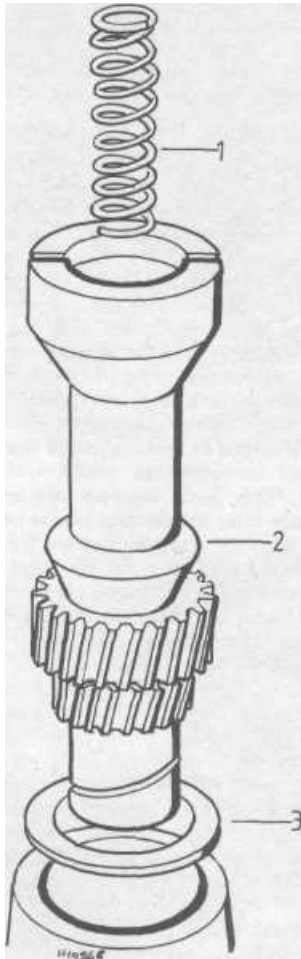
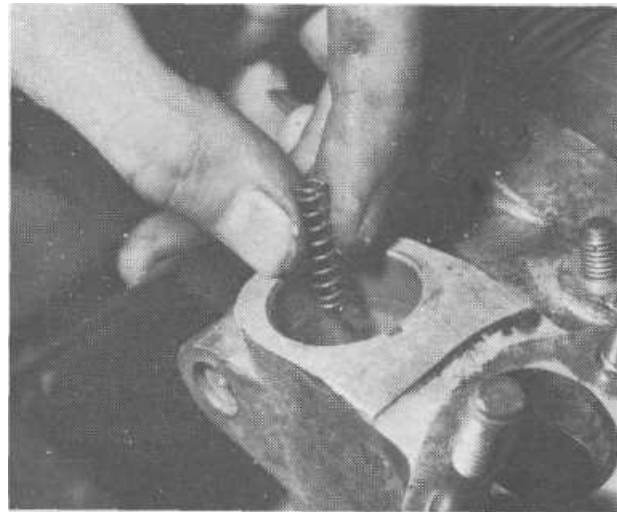


FIG.4.3 DISTRIBUTOR DRIVE SHAFT (Sec 6)

- 1 Spacer spring
- 2 Fuel pump drive cam
- 3 Thrust washer



6.8b Replacing the thrust spring

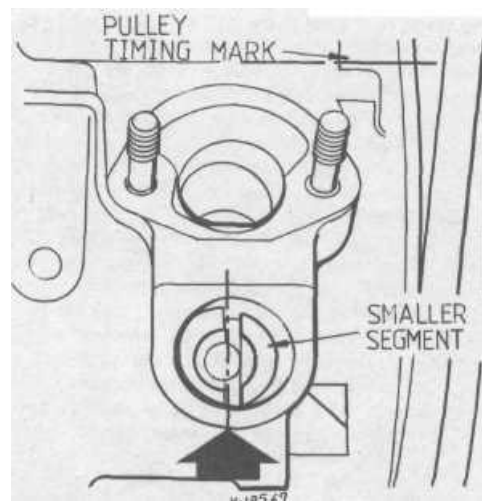


FIG 4.4 CORRECT SETTING OF DISTRIBUTOR DRIVE SHAFT. NO 1 PISTON AT FIRING POINT (Sec 6)

speed will alter so if it falls outside the specified limits adjust the by-pass air screw on the carburettor until it is once more correct. Then check with the stroboscope again.

14 When the mark lines up with the crankcase joint, clamp up the distributor. Reconnect the vacuum hoses as necessary.

15 With the timing set stroboscopically any performance problems with the engine will be due to incorrect carburettor or valve clearance settings. In cold climatic conditions malfunction of the inlet manifold pre-heater and the air intake pre-heater systems could also cause flat spots and poor performance, particularly during acceleration.

## 7 Spark plugs and HT leads

1 The proper operation of the spark plugs is essential to good engine performance and economy. They are also useful indications of engine condition and settings.

2 Make sure you use the correct plugs as listed in the specifications. Every type of engine has its own characteristics calling for a certain spark plug. A different type may be too 'cold' causing deposits to form on the electrodes which would normally burn off. This would result in poor sparking and eventual misfiring. Other plugs may be too 'hot'. These are much more dangerous as the electrodes would overheat and burn away and localised overheating could burn a hole in the piston.

3 Spark plugs today are generally very reliable and give no trouble in an engine which is in normally good condition. Official VW service routines no longer include plug cleaning and setting. They merely renew them every 12000 miles. However, occasion for removal can arise and they are of use in checking the running state of the engine. To remove the Volkswagen plugs it is best to use the special plug spanner supplied with the vehicle (photo). This is quite conventional except that a rubber insert is fitted which grips the plug and enables you to lift it out attached to the spanner. If the plug drops loose under the cover plate you can waste an awful lot of time fiddling about in order to get it out.

4 The colour of a normally operating plug is greyish brown and any deposits on it are usually light. Whitish deposits indicate weak fuel mixtures or overheating, whereas blackish deposits indicate over-rich fuel mixture.

5 If you are unable to have the plugs sand blasted and tested on a proper machine (you could if you carried a spare set) first clean off the deposits by scraping. Considerable deposits may accumulate round the porcelain insulator of the central electrode. This can be scraped out with a fine pointed article (such as an old hacksaw blade ground to a point) but care must be taken not to damage the porcelain. If the porcelain is chipped or cracked anyway the plug must be discarded.

6 The actual electrodes must also be in good condition which means unburnt and comparable to the original length. The centre electrode must project above the end of the threaded body of the plug and the side electrode project across the full diameter of the centre one. The easiest way to assess deterioration is by comparison with a new plug. For cleaning the electrode the side one may be bent up a little to permit a fine file or emery to be used to face off the opposing surface of both electrodes. The surfaces should be flat. Then tap the side electrode down carefully with a feeler blade between the two. The correct gap is 0.6 - 0.7 mm (0.024 - 0.027 inch) (photo). Do not try to bend the centre electrode. The insulation will crack.

7 Do not soak plugs in petrol or paraffin. Even after the spirit is burnt off the residual deposits do more harm than good. If you get persistent problems with plugs oiling up you may have to wash them in spirit but when you get the engine put right buy a new set of plugs.

8 If the exterior insulation is damaged or loose the plug must be renewed. Streaky marks running up the insulation indicate a gas leak between body and insulation. Renew the plug under such circumstances.

9 When replacing the plugs use a new washer if possible - although most plugs nowadays are fitted with captive washers

which makes it somewhat difficult. You are being persuaded to buy new plugs all the time. In any case try to make sure that the seating in the cylinder head where the plug fits is clear of grit or other things that could cause a poor seal. When cleaning the seats it is important to prevent bits dropping into the cylinder. As the Volkswagen plugs are less accessible than most the simplest way is to screw in the plugs a few threads and then direct as strong an air blast as you can find around the plug.

10 DO NOT OVERTIGHTEN PLUGS. The cylinder head is made of aluminium and apart from the risk of stripping the threads the overtightening of plugs can cause heat stresses to crack the head between the plug threads and the valve seat. There is a correct torque of 25 ft lbs/3.5 mkg but if this is not easy to measure then screw in the plug as far as the seat and then just give it a firm 'nip' with the plug spanner.

11 The leads for the plugs must be examined carefully along their length and at each end. The insulation should be clean, uncracked and undamaged in any other way. The metal ends should be free of corrosion. Everything should be dry. Renew any doubtful items and do not try to make do with repairs using insulating tape or such. It is not worth it.

## 8 Coil

1 The coil serves to convert the battery current to the high voltage required to generate a spark at the spark plugs. It consists of a primary winding (low tension) and a secondary winding (high tension) which delivers the high voltage to the distributor rotor and thence to the plugs.

2 Coils do not go wrong very often but they do lose part of their performance if misused and then they make things difficult because the engine will run, but not efficiently.

3 Check first that all the other parts of the ignition circuit are working properly. Then carry out the following tests:

4 Remove the HT cable from the coil to the distributor from the centre of the distributor cap, switch on the ignition, hold the end of the lead (with insulated pliers) about 1/2 inch from the cylinder block and turn the engine over with the starter. There should be a spark. If there is not then check the voltage at terminal 15. It should be at least 9 volts. If this voltage is higher then check the voltage to earth at terminal 1 (connection to distributor). This should be zero when the distributor points are closed and there should be a reading when they are open. If there is no reading when the points are open then the coil has an open circuit and must be replaced.

5 Even so the coil may respond to this test when cold and still give trouble. The engine may cut out when running at high speeds, or at tickover, and it may be difficult to start.

6 The best thing to do is either to substitute the coil with a known good one, if you are fortunate enough to be able to borrow one, or to take your coil to the VW agent and ask him to test it for you.

## 9 Fault finding

1 Failure of the engine to start easily, misfiring and poor acceleration and fuel consumption can usually be attributed to faults in the ignition system assuming, of course, that the engine is otherwise in reasonable condition. Volkswagen engines have a tendency to be fussy when starting hot. Do not attribute this to ignition until you have tried the hot start method of first pressing the accelerator pedal slowly right to the floor and holding it there before operating the starter motor. This overcomes the tendency to flood the warm engine with excess fuel. When starting from cold remember that an automatic choke is fitted. One quick depression and back of the accelerator pedal will ensure that the fast idle cam is set correctly. The pedal should not be touched after that until the engine fires. If the engine does not fire immediately flooding is likely in which case the 'hot engine' procedure should be followed.

2 The table shows the logical progression to be followed in any

circumstance where the ignition is being checked for correct operation. Do not by-pass any part of this procedure unless the fault is particularly obvious and rectification solves the problem. Such obvious faults would be broken or detached wires. It is assumed that the battery is in good condition and fully charged. It is impracticable to test the circuit otherwise. It also assumes that the battery is connected properly and that the starter motor turns the engine over normally.

**FAULT****CHECK**

No start or starts and misfires

1 Remove HT lead from centre of distributor cap and verify that spark jumps to earth when engine is turned on the starter. If it does, the fault lies in the rotor arm, distributor cap, plug leads or plugs which should be checked in that order. Remove one plug and with the HT lead attached hold the side of it against a good earth. A spark should be visible at the plug points when the engine is turned on the starter. If engine still does not start check fuel system. If this is correct then check the coil as in Section 8.

2 If no spark from coil HT lead check the LT circuit in the following order:

a) Disconnect LT lead from terminal 15 of coil and check that current is coming to the end of the lead. Touch the lead to the coil terminal when a small spark will indicate current. Otherwise use a bulb or voltmeter. (The ignition must of course be switched on). If no current indicated check the wiring from the ignition switch.

b) With the LT leads connected to the coil and the HT lead from the coil disconnected at the distributor cap, remove the distributor cap. Turn the engine until the points are closed. Switch on the ignition. Hold the HT lead from the coil near a metal earth and open the points with a non-metallic article. If a spark now jumps from the end of the HT lead clean and reset the points to cure the trouble.

c) If there is no spark from the HT lead but a large spark from the points when opened as in para, (b) the condenser is faulty. It should be renewed.

d) If there is no spark from the HT lead, and no spark large or small at the points when opened as in para, (b) the winding of the coil has probably failed. Check that current is actually passing through the coil to terminal 1 from terminal 15. Do this by having the ignition switched on, the lead to terminal 15 connected and a test lamp or voltmeter from terminal 1 to earth. If there is no voltage then renew the coil.

Engine starts readily but the performance

1 Check the contact breaker points gap.

is sluggish, no misfiring.

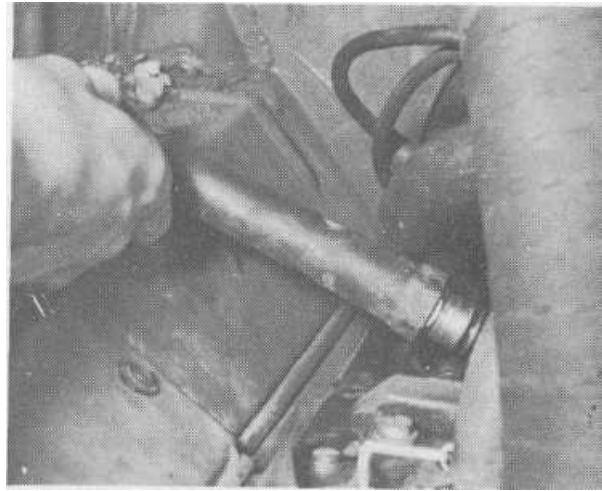
Engine misfires, runs unevenly, cuts out at low revolutions only.

Engine misfires at high revolutions.

- 2 Check the plugs.
- 3 Check the ignition timing.
- 4 Check the fuel octane rating.

- 1 Check the contact breaker gap (too large).
- 2 Check the plugs.
- 3 Check the fuel system (carburettor).
- 4 Check wear in distributor shaft.
- 5 Check the coil (as Section 8).

- 1 Check the plugs.
- 2 Check the contact breaker gap (too small).
- 3 Check the fuel system (carburettor).
- 4 Check the distributor shaft for wear.
- 5 Check the coil (as in Section 8).



7.3 Use the special plug spanner supplied

# Chapter 5 Clutch and operating mechanism

## Contents

General description ... .. 1	Clutch release operating mechanism- inspection and repair 4
Clutch cable - removal, replacement and adjustment ... 2	Fault diagnosis ... .. 5
Clutch assembly - removal, inspection and replacement ... 3	

Type ... ..	Single plate dry uisc
Upto 1968. . . . .	Coil springs
After 1968. . . . .	Diaphragm
After 1972 .. . . .	Modified diaphragm

### Diameter

Coil spring and diaphragm ... ..	7.8 in (200 mm)
----------------------------------	-----------------

### Pedal free travel

To 1973. . . . .	.0.4-0.8 in (10-20 mm)
1973 on. . . . .	.0.63-1 in (15-25 mm)

### Torque wrench settings

Clutch cover to flywheel bolts. . . . .	.18 lb ft/2.5 m kg
---	--------------------

## 1 General description

The clutch is a single disc design and incorporates a driven plate (which carries the friction material on each side) and a pressure plate and cover assembly. The pressure plate is tensioned by a diaphragm spring (or coil springs on early models) incorporated in the cover assembly.

The clutch operating lever pivots in the forward end of the gearbox casing and a thrust bearing on the inner end bears on to the ends of the three release fingers when the arm is operated. The operating arm is moved by a cable from the clutch pedal.

As the friction surfaces of the driven plate wear so the clearance between the thrust ring and release fingers decreases. This clearance is reflected in the free play movement of the clutch pedal. The movement can be adjusted by altering the length of the cable. This is effected by turning the adjuster nut fitted to the clutch end of the cable.

## 2 Clutch cable - removal, replacement and adjustment

1 Clutch cables rarely break and do not stretch significantly so if you find that the clutch is slipping and further adjustment is not possible the cause is the clutch friction plate. Do not think that the cable is at fault.

2 To remove the cable jack up the rear of the car and remove the left hand wheel. Unscrew the cable adjusting nut from the threaded end (photo).

3 If the cable inner only is to be removed it is not necessary to disturb the outer sheath. If the outer is being taken off as well then the mounting bracket bolted to the transmission casting should be taken off. Reassembly will then be much easier.

4 Access to the front end of the cable requires that the panel covering the underside at the front is first removed. This necessitates removing the small hexagon head screws. The front of the cable is held to the pedal lever by a clevis pin secured by a lock

plate. Bend up the lock plate and remove the pin. The cable may then be drawn out from the front. If broken draw out the other piece from the rear.

5 Grease the cable thoroughly prior to replacement and make sure that the rubber sleeves are positioned correctly to seal the ends of the guide tube against the entry of water and dirt (photo). Refit the adjusting nut to the threaded end of the cable.

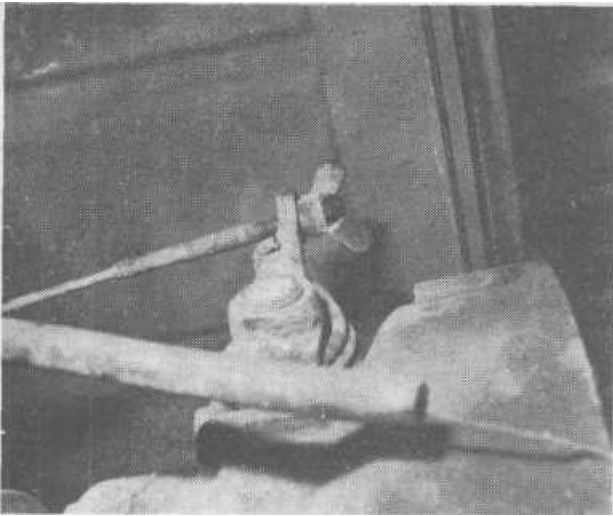
6 When adjusting the clutch, the pedal is the indicating factor. The top of the pedal should move forward  $\frac{1}{4}$  inch (12 mm) before firmer resistance is felt. If it moves more than this the adjuster needs screwing up to shorten the cable. If it moves less then slacken the adjuster. When the adjustment is taken up all the way and the free play is excessive then the driven plate is in need of replacement.

7 Stiff or uneven operation of the clutch could be due to several factors. One check worth making before doing anything too drastic is on the cable outer cover at the rear end. The outer sleeve should have a bend in it and the lowest point of this bend should be between 1-1½ inches (25-45 mm) from an imaginary straight line between the ends of the sleeve. The latitude is generous so the measurement is easy enough. Should there be a variation outside these limits (a most unusual occurrence unless the sleeve has been disconnected and wrongly refitted) adjustments can be made. Disconnect the inner cable from the clutch operating lever, on the transmission casing and add or remove washers to the shoulder of the sleeve as required.

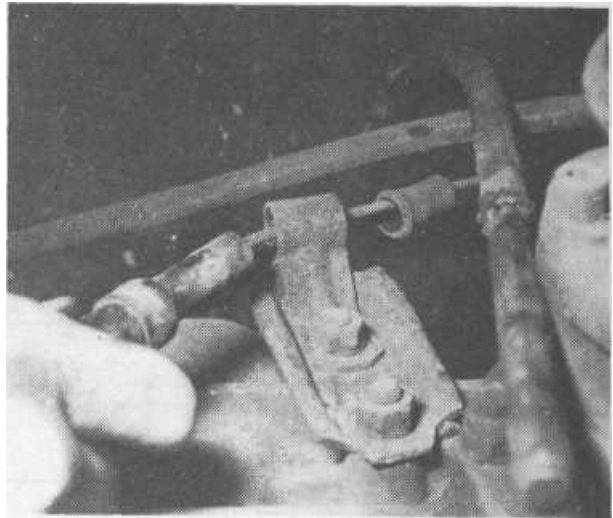
## 3 Clutch assembly • removal, inspection and replacement

- 1 Remove the engine as described in Chapter 1.
- 2 Mark the flywheel and clutch cover with a punch so that they may be lined up on replacement if the old cover is being fitted again.
- 3 Working with a diagonal rotation slacken the six mounting screws which hold the clutch cover to the flywheel - slackening each one a little at a time until the tension is completely

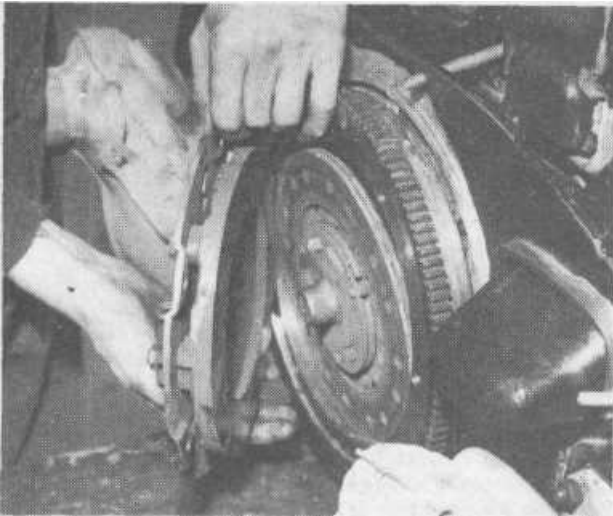




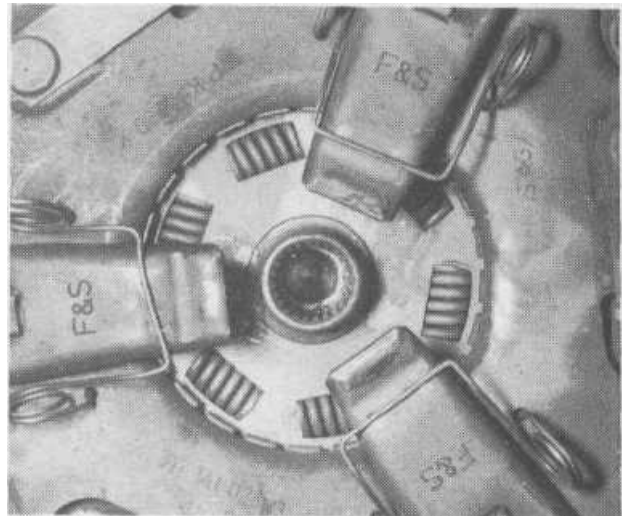
2.2 Clutch cable adjusting wing nut



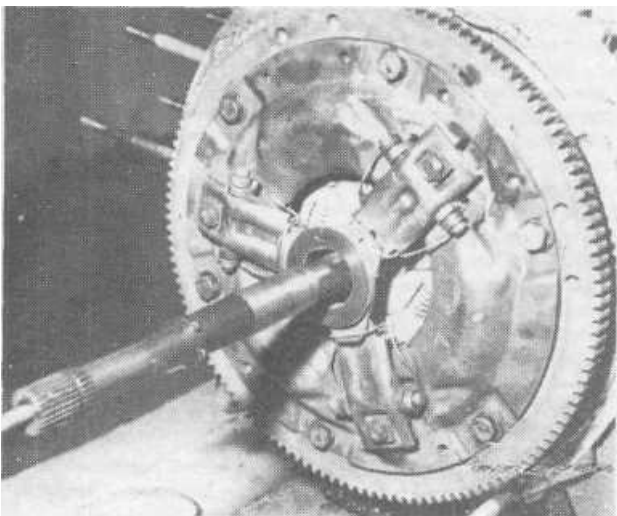
2.5 Make sure the rubber dirt excluding caps are refitted



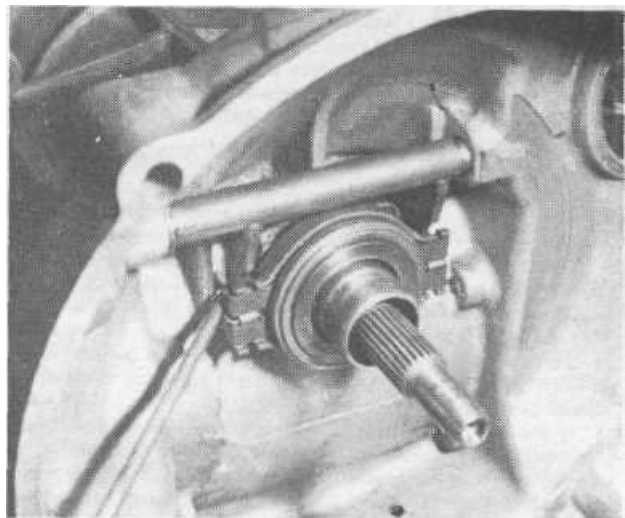
3.9 Replacing the driven plate and cover assembly



3.10a Centre the clutch plate on the flywheel (typical components)

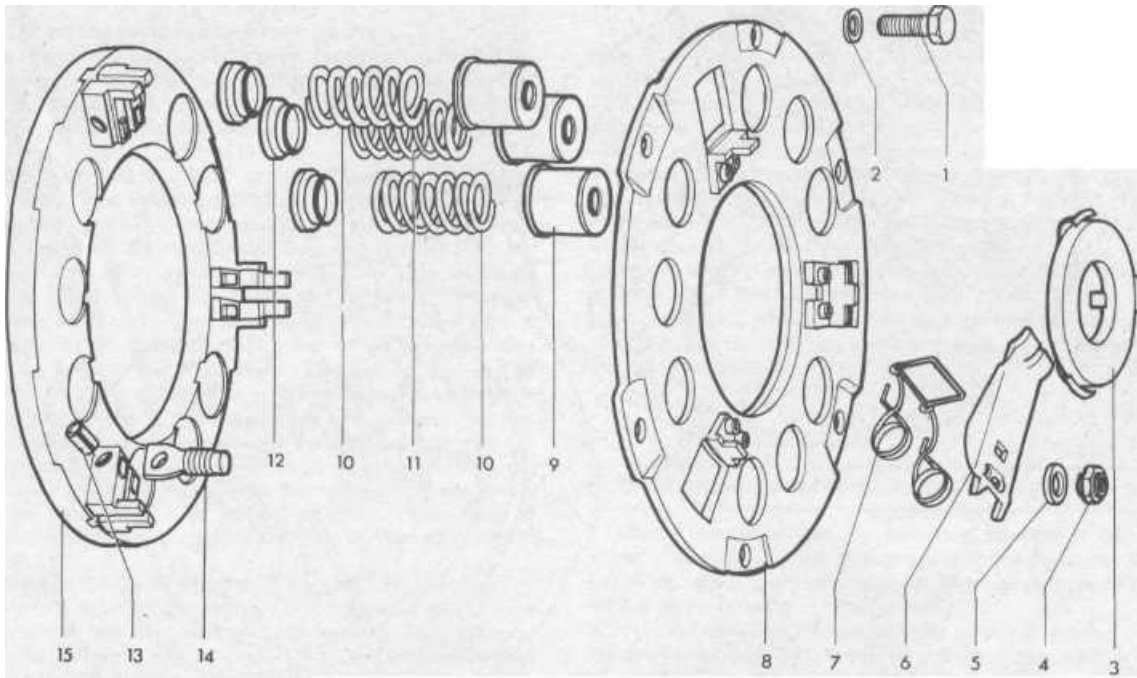


3.10b If the gear box is dismantled use the input shaft to centre the clutch (typical components)



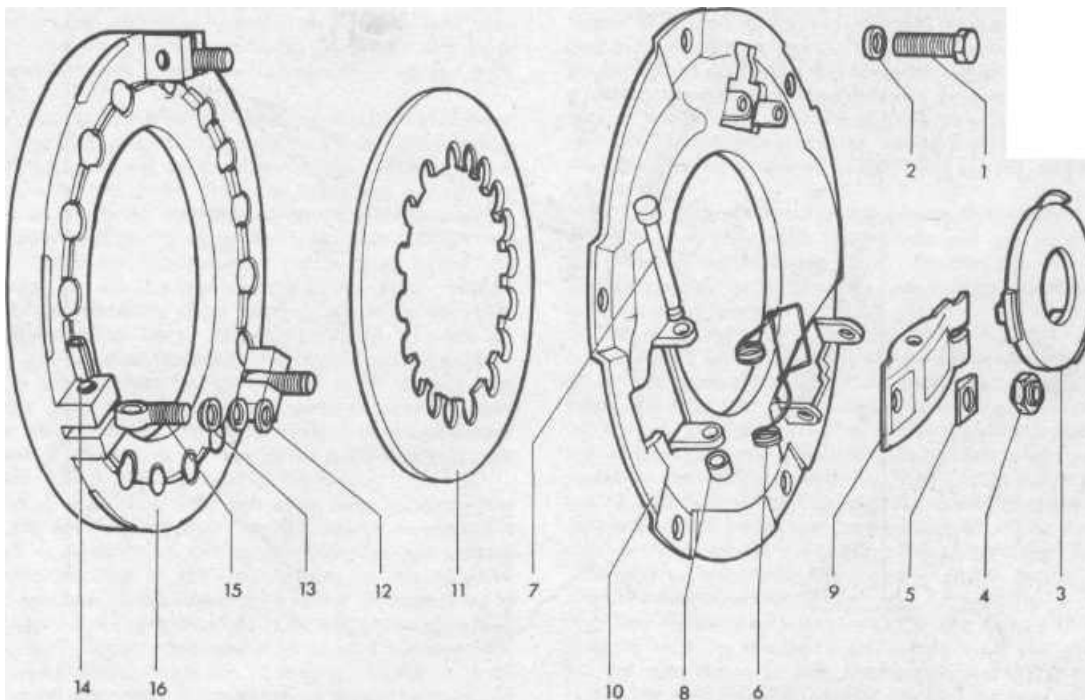
4.4 Clutch release thrust bearing





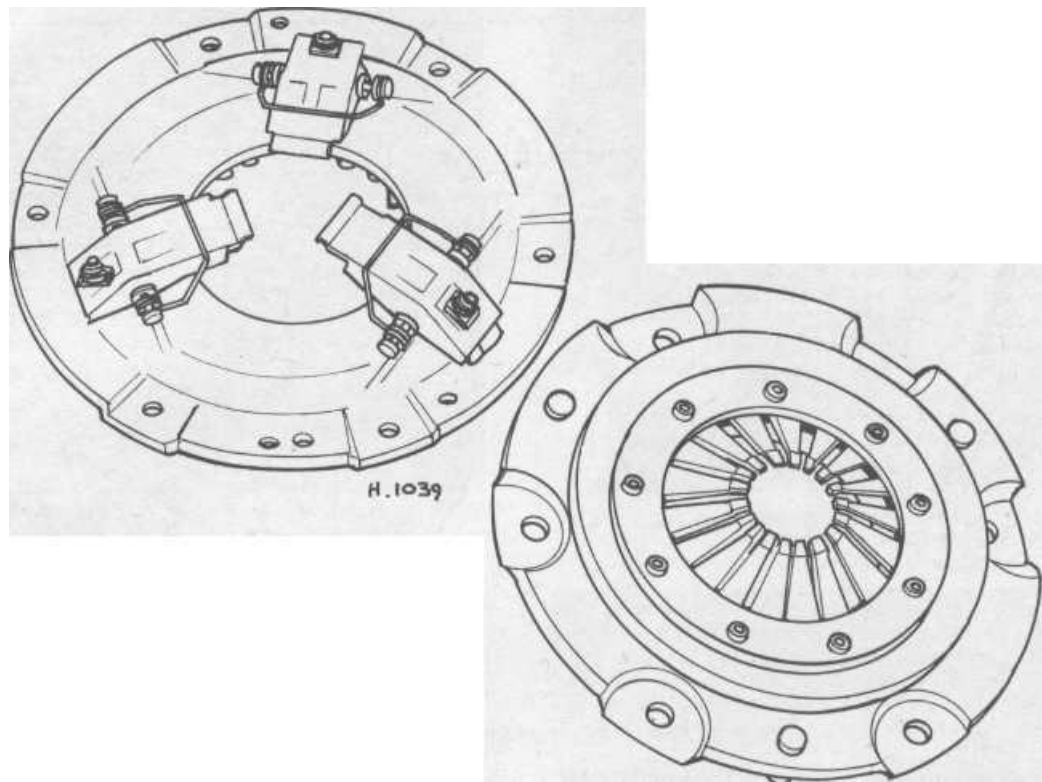
**FIG.5.1 EARLY CLUTCH UNIT - COIL SPRING TYPE**

- |                        |                   |                   |                 |
|------------------------|-------------------|-------------------|-----------------|
| 1 Cover securing screw | 5 Pressure collar | 9 Spring cap      | 13 Spring pin   |
| 2 Lock washer          | 6 Release lever   | 10 Spring (white) | 14 Pivot pin    |
| 3 Release ring         | 7 Spring          | 11 Spring (red)   | 15 Clutch plate |
| 4 Adjusting nut        | 8 Cover plate     | 12 Spring seat    |                 |

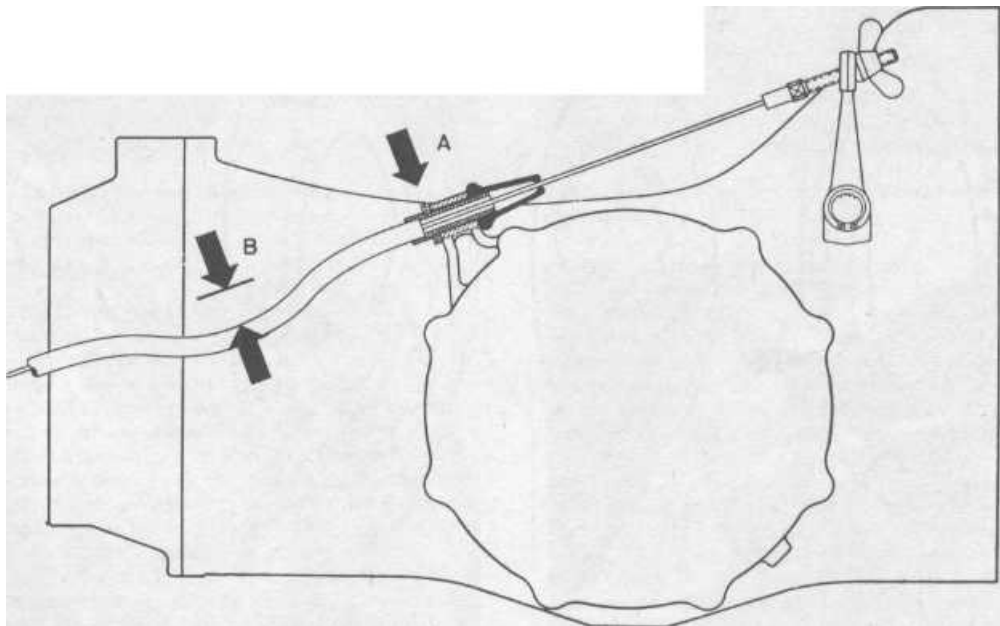


**FIG.5.2 LATER CLUTCH UNIT - TYPICAL DIAPHRAGM SPRING TYPE**

- |                 |                    |                     |                   |
|-----------------|--------------------|---------------------|-------------------|
| 1 Bolt          | 5 Thrust piece     | 9 Release lever     | 13 Concave washer |
| 2 Lock washer   | 6 Spring           | 10 Clutch cover     | 14 Spring pin     |
| 3 Release ring  | 7 Clutch cover pin | 11 Diaphragm spring | 15 Pivot pin      |
| 4 Adjusting nut | 8 Locking bush     | 12 Pivot pin washer | 16 Pressure plate |



**FIG.5.3 COMPARISON OF EARLY TYPE (LEFT) AND LATER VERSION (RIGHT) OF THE DIAPHRAGM SPRING CLUTCH COVER**



**FIG.5.4 CLUTCH OPERATING CABLE OUTER SLEEVE**

*A Adjustment washer location  
B Bend measurement (1 - 1% in)*

relieved. Lift off the cover and clutch driven plate.

4 The clutch driven plate should be inspected for wear and for contamination by oil. Wear is gauged by the depth of the rivet heads below the surface of the friction material. If this is less than 0.025 inch (0.6 mm) the linings are worn enough to justify renewal.

5 Examine the friction faces of the flywheel and clutch pressure plate. These should be bright and smooth. If the linings have worn too much it is possible that the metal surfaces may have been scored by the rivet heads. Dust and grit can have the same effect. If the scoring is very severe it could mean that even with a new clutch driven plate, slip and juddering and other malfunctions will recur. Deep scoring on the flywheel face is serious because the flywheel will have to be removed and machined by a specialist, or renewed. This can be costly. The same applies to the pressure plate in the cover although this is a less costly affair. If the friction linings seem unworn yet are blackened and shiny then the cause is almost certainly due to oil. Such a condition also requires renewal of the plate. The source of oil must be traced also. It will be due to a leaking seal on the transmission input shaft (Chapter 6 gives details of renewal) or on the front of the engine crankshaft (see Chapter 1 for details of renewal).

6 If the reason for removal of the clutch has been because of slip and the slip has been allowed to go on for any length of time it is possible that the heat generated will have adversely affected the spring in the cover, with the result that the pressure is now uneven and/or insufficient to prevent slip, even with a new friction plate. It is recommended that under such circumstances a new assembly is fitted.

7 Although it is possible to dismantle the clutch cover assembly and, in theory, renew the various parts and levers the economics do not justify it. Clutch cover assemblies are available on an exchange basis. The component parts for their overhaul are held at the Central Reconditioning Depots and are not readily available at the Store Depots. It will probably be necessary to order an assembly in advance as most agencies other than the large Central Depots carry stocks only sufficient to meet their own requirements. However, it is possible to get assemblies from reputable manufacturers other than Volkswagen; Borg and Beck for instance.

8 If a new clutch cover is to be fitted make certain that there are no securing clips left in position. There may be no indications on the package so ask the supplier if any are fitted.

9 When replacing the clutch, hold the cover and support the friction disc on one finger through the centre. Be sure that the facing with radial lines goes towards the flywheel (the longer hub boss towards the cover), (photo). Position the cover so that the locating marks line up. If a new cover is being fitted it will be necessary to check whether there are any imbalance marks on either the flywheel or cover. On the flywheel this can be indicated by a 5 mm diameter countersunk hole or a white paint mark on the outer edge. On the clutch cover it would be indicated by a white paint mark on the outer edge. If only one (flywheel or cover) has an imbalance mark it does not matter how the cover is fitted. If both have marks make sure that they are 180° apart (i.e. on opposite sides of the circle).

10 Replace the six securing bolts and screw them up evenly just enough to grip the friction plate but not enough to prevent it being moved. It is important to line up the central splined hub with the roller bearing in the counterbore of the flywheel locking bolt (photo). If this is not done it will be impossible to refit the engine to the transmission. It is possible to centralise them by eye but a simple surer way is to select a suitable piece of bar or wooden dowel which will fit snugly into the flywheel and round which some adhesive tape can be wound to equal the diameter inside the friction plate boss. By inserting this the friction plate can be moved and centralised with sufficient accuracy.

If you happen to have the gearbox dismantled at the same time then of course you should use the input shaft from that (photo).

11 Finally tighten up the six cover securing bolts evenly and diagonally a little each at a time to a final torque of 18 lb ft. On later models, socket headed screws are used instead of bolts. These are interchangeable with the earlier type bolts.

12 Before refitting the engine after a clutch overhaul check the transmission input shaft oil seal (Chapter 6) and the clutch release operating mechanism (see Section 4).

13 Before finally offering up the engine dust the splines of the gearbox input shaft (which should, of course, be clean and in good condition) with a little graphite or molybdenum powder. Also put a little molybdenum paste (not oil or grease) on the face of the release bearing.

#### 4 Clutch release operating mechanism - inspection and repair

1 Clutch operation can be adversely affected if the release thrust ring and retaining springs are worn or damaged. Squeals, juddering, slipping or snatching could be caused partly or even wholly by this mechanism being worn.

2 Full examination is possible only when the engine has been removed and normally it is carried out when the clutch is in need of repair. The mechanism is contained in and attached to the transmission casing. Check first that the operating lever return spring mounted on the exterior of the shaft on the left hand side is not broken. If it is it can be renewed without removing the engine; once the lever has been disconnected from the cable and taken off the cross shaft. However, the damage which failure of this spring may have caused has probably occurred already. If you are going to examine the clutch anyway it will be easier to renew the spring after the engine is removed.

3 The release bearing is attached to the lever by clips in the transmission casing. On early models it operates on to a thrust ring incorporated in the clutch cover release fingers. Later the thrust bearing operates direct on to the fingers.

4 With the engine removed examine the release bearing and the face. It should spin silently and show no signs of wear or other damage. The retaining clips at each side must be a tight fit so that the bearing does not rattle about on the mounting forks (photo).

5 Do not wash the bearing in any cleaning fluid. It is sealed and although fluid may wash some grease out you cannot get any more in. If it needs renewal pull off the clips and lift it out.

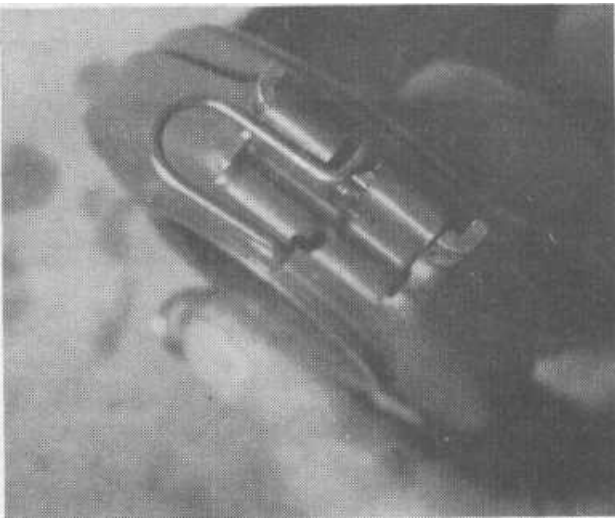
6 When replacing the thrust release bearing fit the clips so that the ends point upwards (photo).

7 The cross shaft itself runs through the casing and should be freely moving and without any sign of slackness in the bushes.

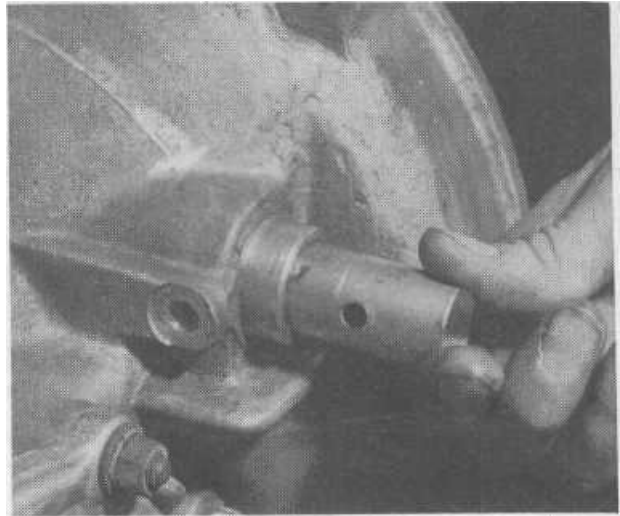
8 If it is necessary to renew the bushes the cross shaft can be taken out after first taking the operating lever and return spring off the end of the shaft. Then remove the screw which locates the bush in the casing and remove all the components. When replacing the shaft lubricate well with molybdenum grease and ensure that the two concertina type grease seals are intact and properly seated inside the casing (photos). If one should come out on the inside of the casing make sure you get it put back. This bush takes considerable forces when the clutch is operated and should not be ignored.

9 When fitting a new return spring first remove the operating lever by undoing the circlip and taking it off the splined shaft. Fit the new spring so that the hooked end will eventually go round the lever and hold it back. Replace the lever and hook the spring end round it (photo).

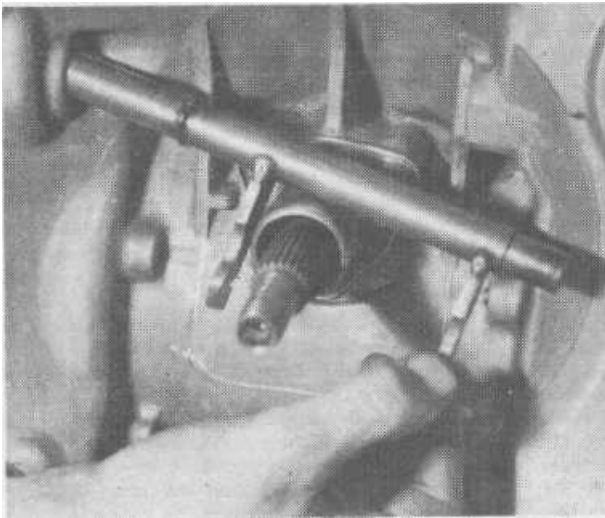
10 Re-adjust the clutch pedal play after the engine has been replaced.



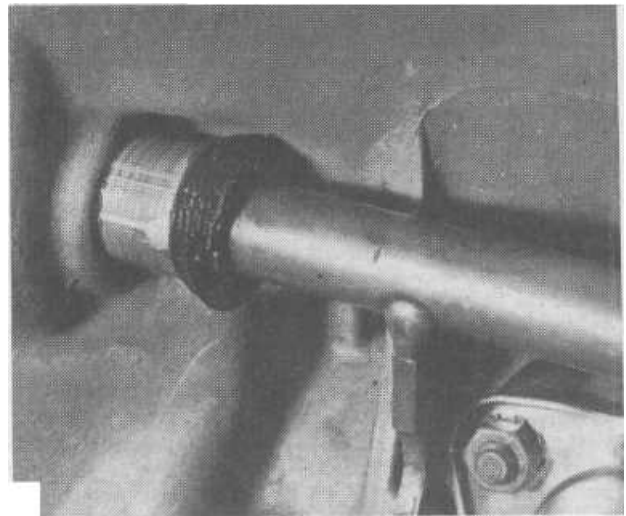
4.6 View of the bearing attachment clips



4.8a Fitting the clutch release shaft bush



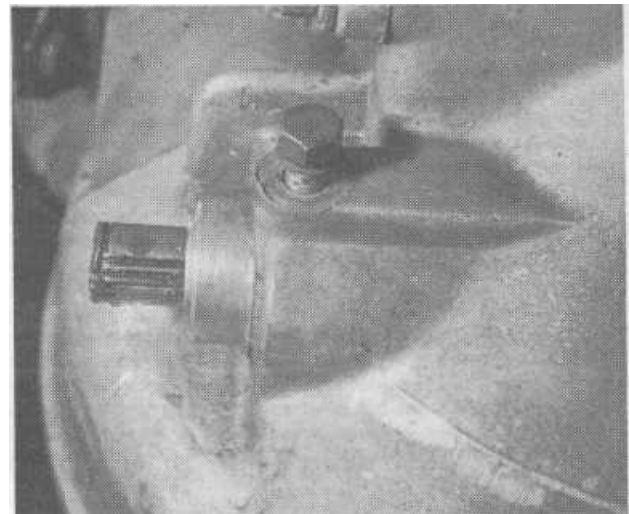
4.8b ... followed by the shaft .....



4.8c ... and bearing sleeve and seals.



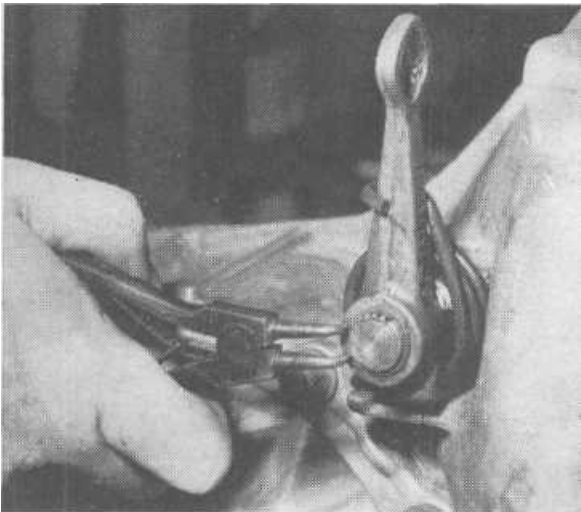
4.8d Make sure the bush and seal do not come out on the inside like this



4.8e The locating screw for the bush and sleeve

## 5 Fault diagnosis

Symptoms	Reason/s	Remedy
Judder when taking up drive	Loose engine/gearbox mountings or over flexible mountings Badly worn friction surfaces or friction plate contaminated with oil deposits  Worn splines in the friction plate hub or on the gearbox input shaft Badly worn roller bearings in flywheel centre for input shaft spigot	Check and tighten all mounting bolts and replace any 'soft' or broken mountings. Remove engine and replace clutch parts as required. Rectify any oil leakage points which may have caused contamination.  Renew friction plate and/or input shaft.  Renew roller bearings in flywheel gland nut.
Clutch spin (failure to disengage) so that gears cannot be meshed	Clutch actuating cable clearance too great Clutch friction disc sticking because of rust on lining or splines (usually apparent after standing idle for some length of time)  Damaged or misaligned pressure plate assembly	Adjust clearance. As temporary remedy engage top gear, apply handbrake, depress clutch and start engine. (If very badly stuck engine will not turn). When running rev up engine and slip clutch until disengagement is normally possible. Renew friction plate at earliest opportunity.  Replace pressure plate assembly.
Clutch slip- (increase in engine speed does not result in increase in vehicle speed - especially on hills)	Clutch pedal free play too little or non-existent resulting in partially disengaged clutch at all times Clutch friction surfaces worn out (beyond further adjustment of operating cable) or clutch surfaces oil soaked	Adjust clearance.  Replace friction plate and remedy source of oil leakage.



4.9 The release shaft operating lever showing circlip splines and return spring

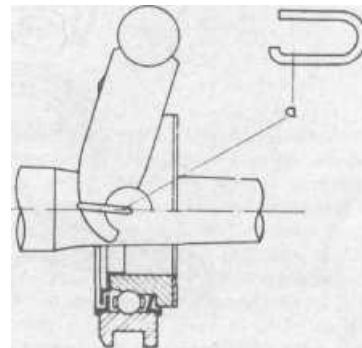


FIG.5.5 CLUTCH RELEASE BEARING. CROSS SECTION SHOWING SHAPE AND LOCATION OF RETAINING CLIP (a)

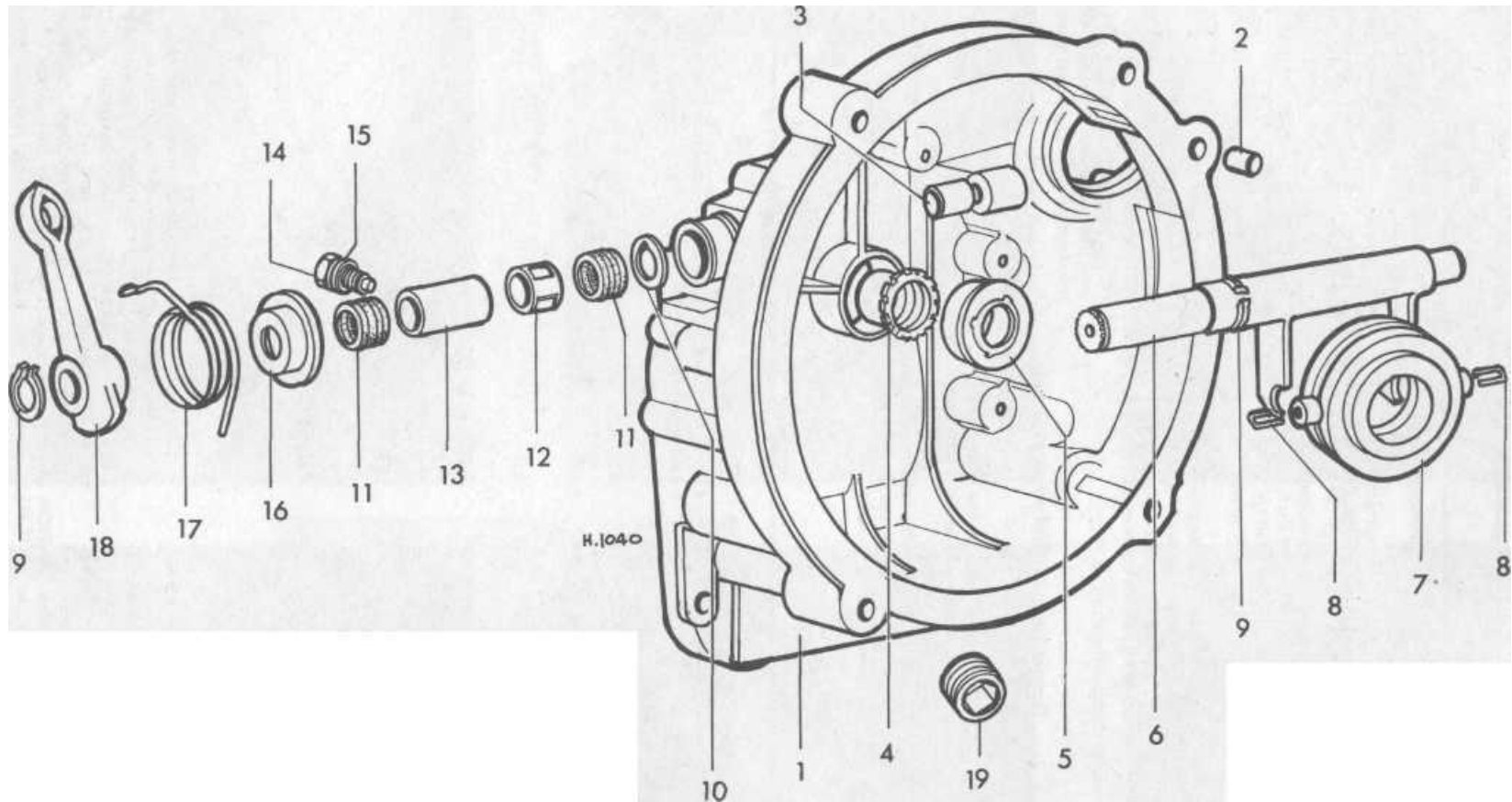


FIG.5.6 CLUTCH RELEASE MECHANISM - COMPONENTS

- |                          |                          |                  |                           |
|--------------------------|--------------------------|------------------|---------------------------|
| 7 Clutch housing         | 6 Clutch operating shaft | 11 Rubber seal   | 16 Spring locating collar |
| 2 Bush - starter pinion  | 7 Release bearing        | 12 Bush          | 17 Return spring          |
| 3 Bush - operating shaft | 8 Retaining spring       | 13 Sleeve        | 18 Clutch lever           |
| 4 Oil return sleeve      | 9 Circlip                | 14 Lock screw    | 19 Drain plug             |
| 5 Oil seal • drive shaft | 10 Washer                | 15 Spring washer |                           |

# Chapter 6 Transmission and final drive

For modifications, and information applicable to later models, see Supplement at end of manual

## Contents

General description	...	...	...	...	1	Gear carrier and shafts - assembly into casing	...	...	5F
Transmission - removal and replacement	...	...	...	...	2	Gear selector levers and cover - reassembly	...	...	5G
Transmission - dismantling	...	...	...	...	3	Final drive and bearings - replacement	...	...	5H
Inspection for wear in transmission components	...	...	...	...	4	Synchromesh hub assemblies - dismantling, inspection and reassembly	...	...	6
Transmission reassembly - general	...	...	...	...	5	Input shaft oil seal - renewal	...	...	7
Input shaft - reassembly	...	...	...	...	5A	Differential	...	...	8
Pinion shaft - reassembly	...	...	...	...	5B	Limited slip differential	...	...	9
Main casing - installing bearings and reverse gearshaft	...	...	...	...	5C	Gear change lever and linkage	...	...	10
Gear carrier - fitting bearings	...	...	...	...	5D	Fault diagnosis	...	...	11
Gear carrier - fitting shafts and selector forks	...	...	...	...	5E				

## Specifications

### Identification code

CA	Normal
CB	Mountain ratio
CC	Normal with limited slip
CD	Mountain ratio with limited slip

### No. of gears

4 forward, 1 reverse

### Synchromesh

Baulk ring on all forward gears

### Oil capacity

3.5 litres/6.125 Imperial pints

### Gear ratio.<sup>1</sup>

First	3.80:1
Second	2.06:1
Third	1.26:1
Fourth	0.82:1
Reverse	3.61:1

### Final drive ratio

Normal ratio	5.375:1
Mountain ratio	5.857:1

### Torque wrench settings

	ft lbs	m Kg
Oil filler and drain plugs	14	2.0
Casing and cover nuts	14	2.0
Pinion shaft retainer nuts	22	3.0
Pinion shaft retaining ring (Type 2/69)	160	22.0
Pinion bearing slotted nut	144	20.0
Reverse gear clamp sleeve/union nut	14	2.0

## 1 General description

The gearbox and final drive is a one piece composite assembly housed in a 'tunnel' type magnesium alloy die casting. Unlike the more orthodox design of gearbox which has an input and output shaft aligned on the same axis with a layshaft and gears below, the VW has an input shaft and output shaft only mounted alongside each other and each carrying a synchro hub. This is because the input and output power is at the same end of each shaft. The output shaft incorporates the pinion gear which meshes with the crown wheel.

Synchromesh is used for all four forward speeds.

The whole assembly is supported in the vehicle as part of the engine/gearbox unit. The front end is supported on bearers attached to the centre of the frame cross tube which supports the rear suspension. The rear end is held up by the engine (photo). The transmission casing includes the final drive gear which comes between the engine and the gearbox.

In view of the relative complexity unit, it is felt that a few words of warning should be given in order to let potential dismantlers fully realise what they may be letting themselves in for. First of all decide whether the fault you wish to repair is worth all the time and effort involved. Secondly, if the gearbox is in a



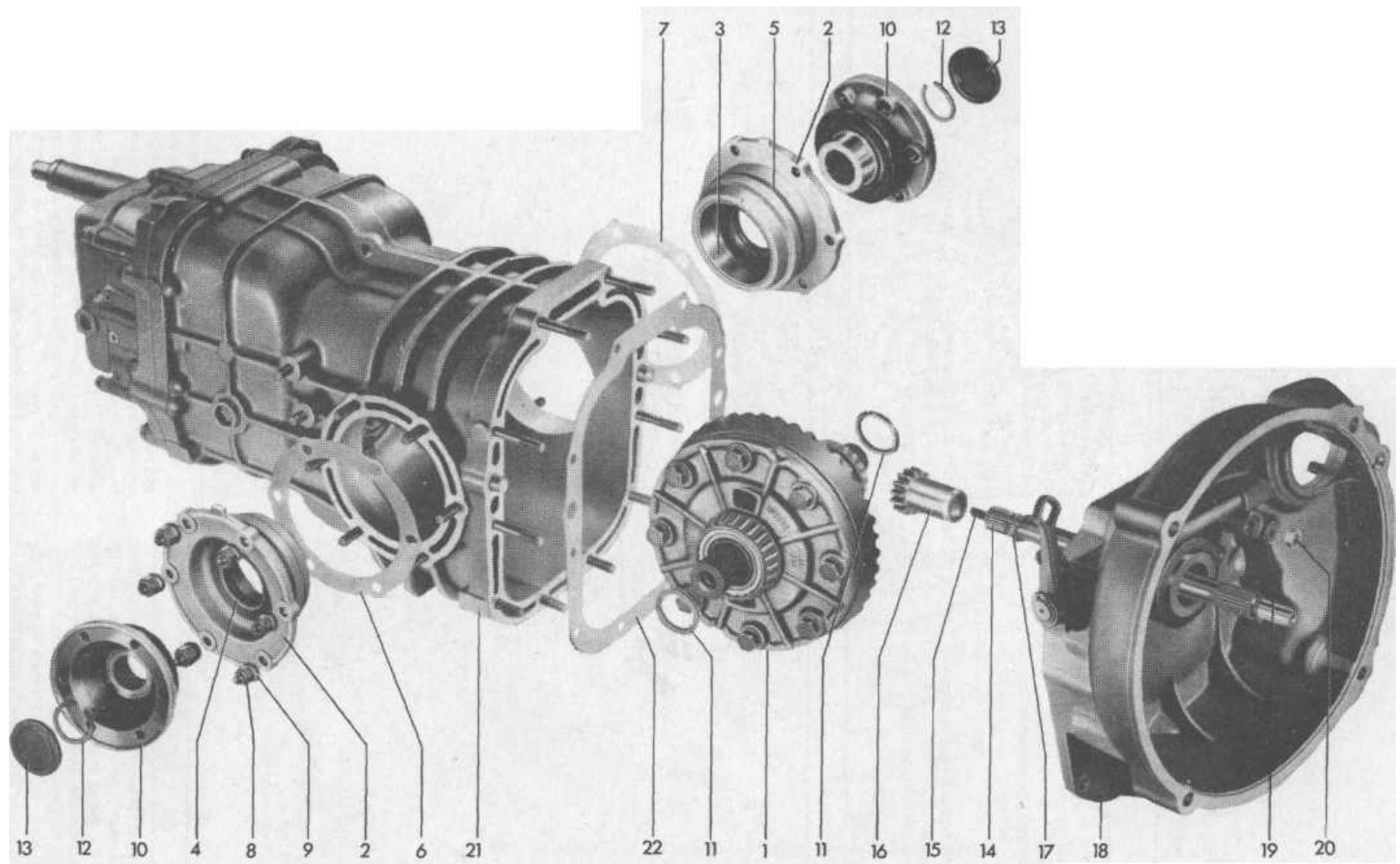
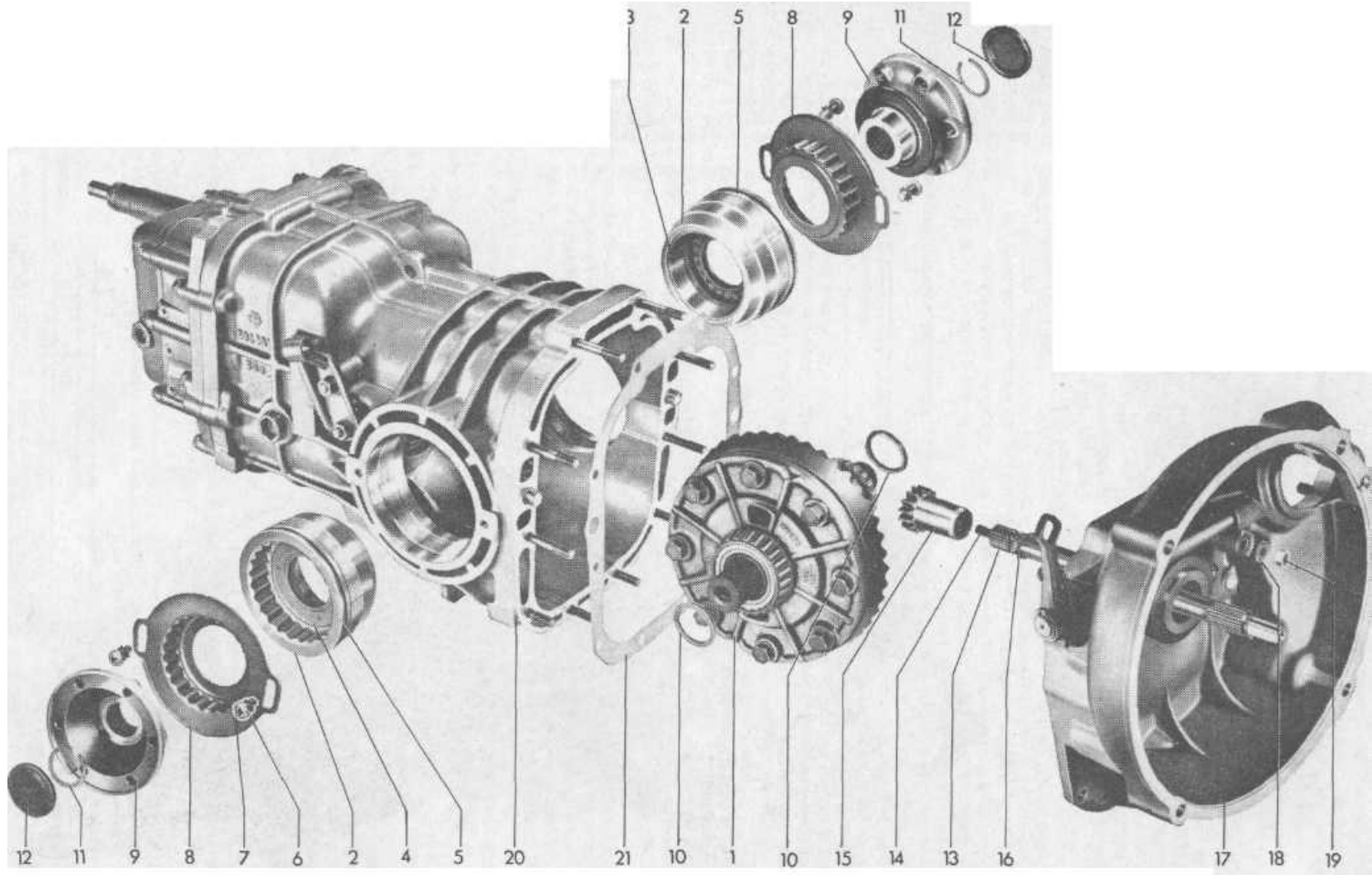


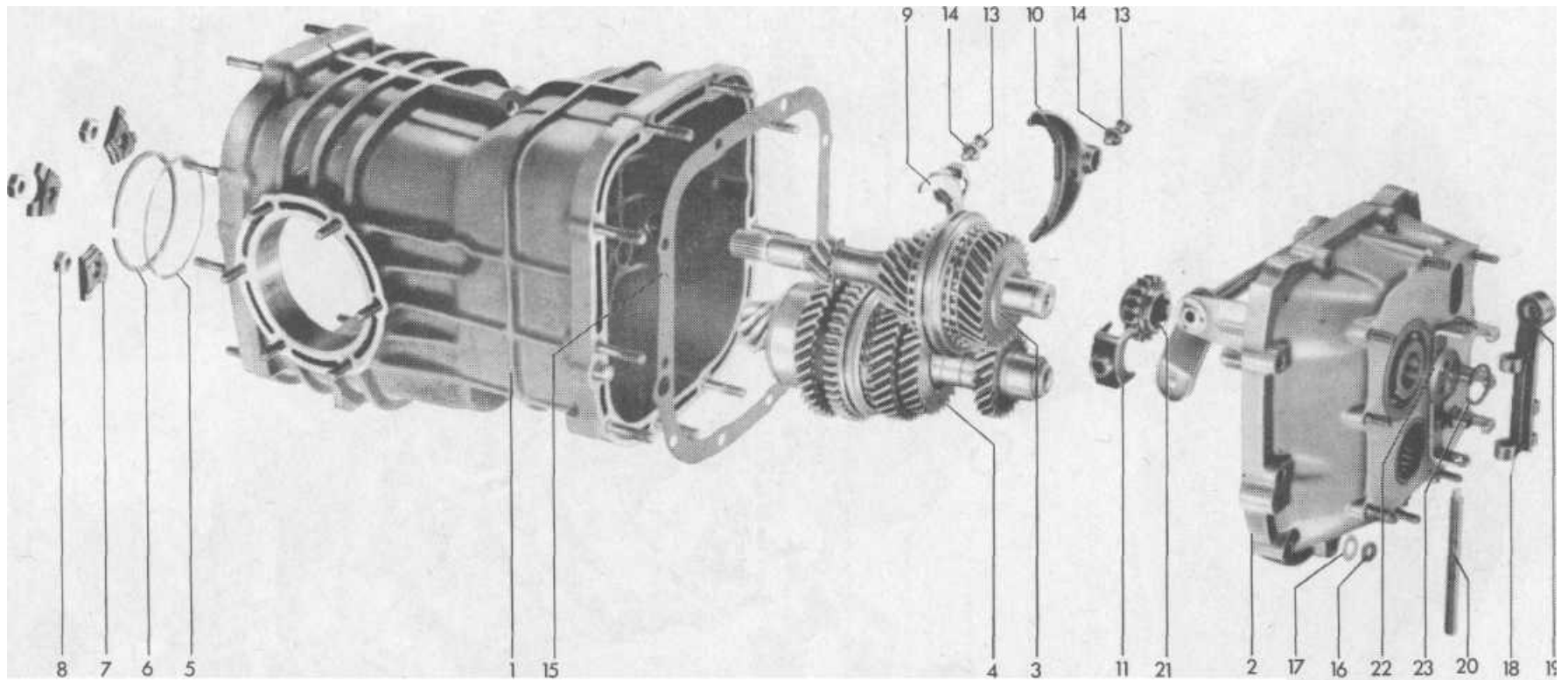
FIG.6.1 FINAL DRIVE AND DIFFERENTIAL (TO AUGUST 1968) (Sec 3)

7 Differential	4 Oil seal	8 Cap nut	12 Circlip	16 Reverse gear sleeve	20 Nut
2 Side covers	5 'O' ring	9 Spring washer	13 Sealing cap	17 Circlip	21 Transmission case
3 Outer race taper roller bearings	6 Shim	10 Joint flange	14 Drive shaft, rear (input)	18 Clutch housing	22 Gasket
	7 Shim	11 Spacer ring	15 Stud (connecting)	19 Spring washer	



**FIG.6.2 FINAL DRIVE AND DIFFERENTIAL (FROM AUGUST 1968) (Sec 3)**

- |                                     |               |                  |                                    |                        |                      |
|-------------------------------------|---------------|------------------|------------------------------------|------------------------|----------------------|
| 1 Differential                      | 4 Oil seal    | 8 Lock plate     | 12 Cap                             | 15 Reverse gear sleeve | 19 Nut               |
| 2 Adjusting ring                    | 5 'O' Ring    | 9 Flange         | 13 Drive shaft - rear part (input) | 16 Circlip             | 20 Transmission case |
| 3 Outer race, taper roller bearings | 6 Lock washer | 10 Spacer washer | 14 Stud (connecting)               | 17 Clutch housing      | 21 Gasket            |
|                                     | 7 Screw       | 11 Circlip       |                                    | 18 Spring washer       |                      |



**FIG 6.3. GEARBOX AND GEAR TRAIN (Sec 3)**

Note: this drawing is correct for gearboxes up to August 1968 after which the pinion shaft fastenings (8) were changed and a pinion retaining nut replaced them. See text Section 3.12.

- |                           |                                |                                      |                  |                       |                         |
|---------------------------|--------------------------------|--------------------------------------|------------------|-----------------------|-------------------------|
| 1 Casing                  | 5 Shim (to August 1968)        | 9 Selector fork 1st/2nd              | 13 Locking screw | 17 Spring washer      | 21 Reverse sliding gear |
| 2 Gear carrier            | 6 Circlip (to August 1968)     | 10 Selector fork 3rd/4th             | 14 Spring washer | 18 Intermediate lever | 22 Dished washer        |
| 3 Drive shaft (mainshaft) | 7 Retainer (to August 1968)    | 11 Selector fork, reverse            | 15 Gasket        | 19 Ball joint         | 23 Circlip              |
| 4 Drive pinion shaft      | 8 Special nut (to August 1968) | 12 Retaining ring (from August 1968) | 16 Nut           | 20 Lever shaft        |                         |

very bad state then the cost of the component parts may well exceed the cost of a new replacement unit. Thirdly, remember that a basic knowledge of gearbox construction and function is a bare necessity before tackling this one. If you are doing one for the first time do not start on a Volkswagen!

Finally, two technical musts. You must be able to have access to the use of a press. So check this before you start. Make sure that you have made contact with an agent who is likely to be able to supply all the new gaskets and parts that may be required. It is not possible to work out exactly what may be required before you start but the minimum will be a gasket set, baulk rings and bearings so check that you can at least get these. The press is essential for dismantling the two shaft assemblies which is necessary if you want to replace the baulk rings.

If you have experience of earlier VW gearboxes there is another word of caution also. With the earlier models each gear-shaft assembly was held together with a large locknut on the end of the shaft which was tightened to a specific torque. For production reasons these nuts have been replaced on later models by circlips used in conjunction with shims and special pressure washers which make assembly even more tricky. A selection of circlips and shims must be available if a major overhaul is contemplated.

Always quote the transmission number stamped on the casing when ordering spares.

## 2 Transmission - removal and replacement

1 As the engine has to be removed anyway it is much simpler to remove it complete with the gearbox attached. Proceed therefore as described in Chapter 1 for removal of the engine with the following exceptions and additions.

2 It is not necessary to remove the two bolts and two nuts holding the engine to the gearbox.

3 Detach both cables from the starter motor.

4 Remove the adjusting nut from the end of the clutch cable.

5 Undo the six screws from each drive shaft inner flange and move the shafts aside. Details are given in Chapter 7.

6 Underneath also, near the front mounting of the transmission, is the gear change rod coupling. This is held by a square headed screw. Undo the securing wire and slacken the screw until the gear change rod is disengaged (photo). This can be done by pulling the change lever in the cab towards 2nd and 4th gear positions.

7 Remove the two nuts and bolts holding the gearbox at the front mounting (photo) and disconnect the braided earth strap from the casing at the front (photo).

8 The whole assembly will rest in position until it is drawn backwards. This must be done on a trolley jack. As soon as the mountings are clear at front and rear the whole unit can be lowered and drawn out from the rear (photos).

9 Replacement is a reversal of the removal procedure bearing the following in mind.

Check the condition of the change lever and rods before installation of the gearbox (See Section 10). Reassemble the engine and gearbox to each other first and refit the starter motor (photo).

Raise the unit into position and then move it forward on to the mountings.

When reconnecting the gear change rod coupling, ensure that the point of the square headed locking screw engages in the recess in the rod.

Refill the transmission with oil before replacement - it is easier (photo). Do not forget to readjust the clutch pedal free play.

## 3 Transmission - dismantling

1 Before proceeding according to the direction given in this Section read the 'General description' Section first. Do not throw away gaskets when dismantling. They act as a guide when working out what new ones to use from the gasket set bought

(see Reassembly Section).

2 It must be remembered that, modifications have been made to the gearbox and continue to be made. It is essential to be very careful when ordering spares that the correct number stamped on the casing is quoted in all instances.

3 Remove the screws and nuts securing the clutch housing to the gear casing at the front and carefully draw it off over the input shaft.

4 Undo the circlip in part of the reverse gear and sleeve on the input shaft and draw it along the shaft so that the gear and sleeve may be drawn along behind it until it is clear of the splined part. Then unscrew the front section of the shaft which is located in to the other part with a threaded stud.

5 Remove the sealing caps from the centres of the driving flanges by punching the blade of a screwdriver through them and levering them out.

6 Remove the circlip from round the splined shaft end. The flange can then be levered off the end of the shaft. Behind the flange is a spacer ring which may be taken off now or left until later. Do the same on both sides.

7 Mark both bearing covers to ensure replacement on the correct side and in the same position. Undo the nuts.

It will be necessary to tap them off quite firmly because there is an 'O' ring sealing them which makes them a tight fit.

8 Carefully remove the shims from the studs and keep them with the appropriate side cover. If they get mixed up you will not be able to reassemble the box properly.

9 Take care not to let the differential fall out as it will now be completely free. Take it out and put it somewhere safe.

10 On later models the side covers are different being actually threaded into the casing. They are locked into position by a plate which is secured by two screws. This plate engages the splines on the internal diameter.

11 Removal of these bearing retainers is best done with a special tool but if none is easily obtainable it is possible to undo them with a suitable punch and hammer. Make very sure that you mark them in relation to the casing before undoing them.

12 Remove the change lever end cover units and take off the cover. The gear selector bar is located by a long pin which can be taken out once the cover is removed. Undo the nuts securing the gear carrier to the casing. Then undo the three screws and retainer plates holding the pinion bearing into the casing. There is also a circlip round the pinion bearing which must be released. Behind this are the pinion shims which must also come out and be carefully protected, on later models (Type 002) a threaded ring replaces the three retainer plates and unless the special tool (VW 381/14) to fit it is available it is virtually impossible to undo it (let alone do it up again!) without the risk of damage.

13 Once the pinion retainer is free the shafts can be drawn out together with the carrier plate. Tap the end of the pinion with a mallet to aid removal.

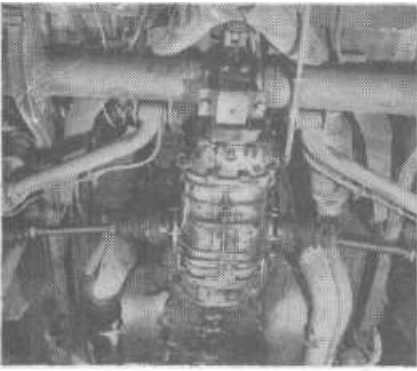
14 Once removed do not dismantle anything further until the position of the selector forks has been carefully marked on the rails (photo). If this is not done and the forks are moved there is the greatest likelihood that gear selection will be upset so that the whole assembly will need repositioning in a special jig.

15 Undo and remove completely the fork clamping screws and then slide them off the rails, moving the rails as necessary (photo) in order to free them. Take note which way round the forks are fitted and which one goes on which rail because they are not the same (photo). Do not drive the rails out of the carrier.

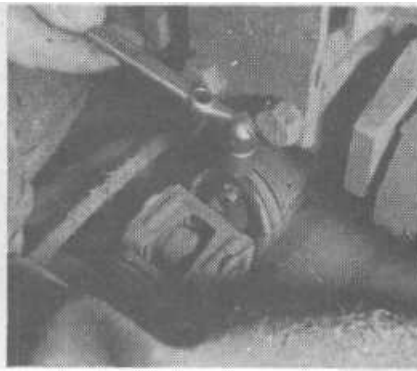
16 The reverse selector lever is on a post clamped by a union nut. Make sure this is marked also before removing it (photo). The brackets which support the reverse selector cross shaft are also adjustable and must be marked before the securing bolts are undone (photo).

17 The input shaft, together with its cluster of gears is supported in the carrier by a roller bearing. The outer race of this bearing is located by a bolt through the casing.

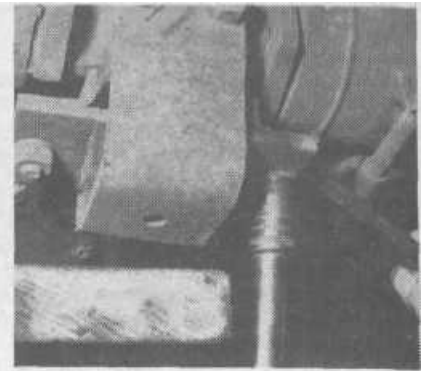
If the bolt is removed the race can be tapped out with a punch from the inside and this will enable the shaft to be taken out.



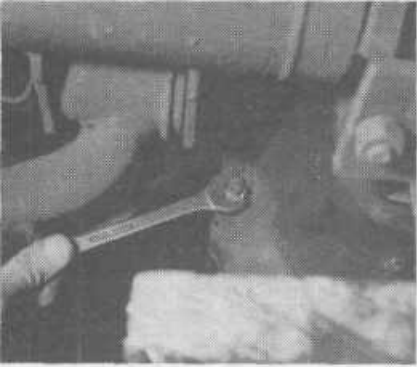
1.1 The transmission from below showing layout and supports



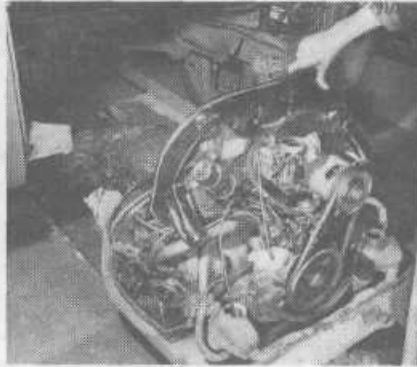
2.6 Undo the square headed screw



2.7a Undo the two nuts holding the gear-box at the front mounting



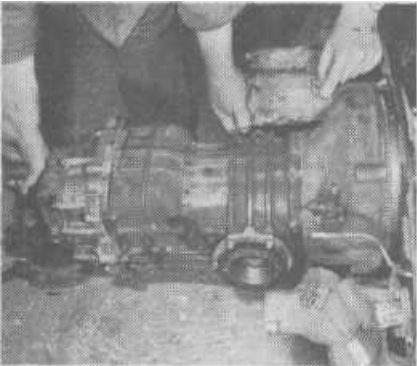
2.7b Remove the earth strap



2.8a Remove the unit to the rear



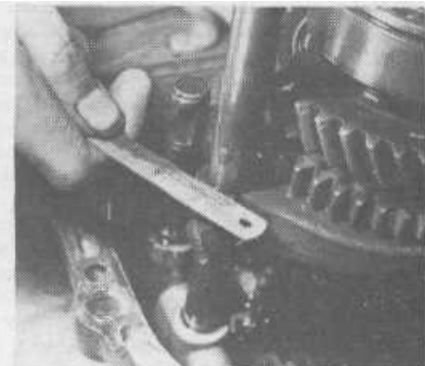
2.8b... and lower it to the ground



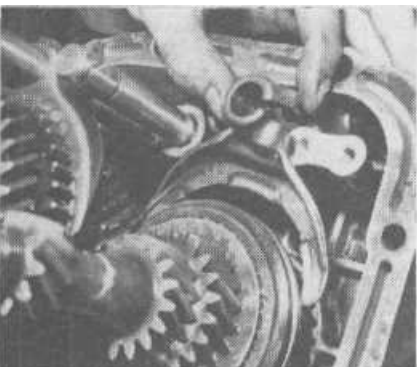
2.9a Assemble the starter motor



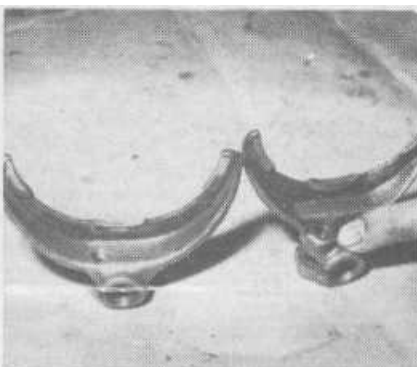
2.9b Fill up the transmission before installation



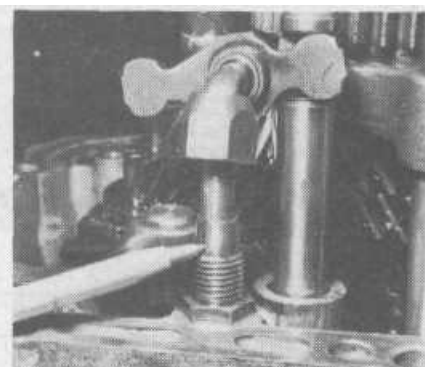
3.14 Mark the position of the selector forks



3.15a Undo the clamping screw completely and remove the selector forks



3.15b The selector forks vary in size



3.16a Note the position of the reverse selector cross shaft before removing it.

18 The pinion shaft is a very tight fit in the ball bearing in the casing. Having removed the circlip and dished washer from the end of the shaft (watch out that the springiness of the washer does not cause the circlip to fly' when it is released) the shaft should be pressed out of the bearing. The bearing is flanged on the outside and cannot therefore be pushed through the carrier with the shaft. If no press is available it is possible to drive the shaft out provided the *earner* is very well supported on blocks with the shaft hanging down (photo). This method has its disadvantages however, because every time a blow is struck on the shaft the bearing transfers the shock to the casing. This is relatively soft metal and after several blows the hard steel of the bearing can 'hammer' away in its seating so that it is no longer a good fit. Only use this method as a last resort. Much depends on the general age and wear in the gearbox as to just how tight this shaft may be in the bearing.

19 Once the shafts are clear of the carrier the bearings may be removed. The main (input) shaft front bearing is driven out from the inside of the carrier. This particular ball bearing is flanged on the outer race and will only come out in one direction.

20 To dismantle the input shaft first take off the thrust washer then 4th gear together with the needle bearing cage on which it runs. Remove the baulk ring. This leaves the inner race on the shaft. To get this off a press will be needed and the 'V' blocks should be suitably positioned to provide support behind the 3rd gear wheel. In this way there will be no danger of damage to the shaft or gears and the synchro hub assembly will be kept together. Make sure that all parts are supported and held whilst being pressed. 3rd gear may then be taken off together with its needle roller bearing. The 3rd bearing inner race need not be removed nor the key which locates the synchro hub. Keep the baulk rings with their respective gears for future reference - fix them with adhesive tape to prevent muddling.

21 The output (pinion) shaft should only be dismantled to a limited extent - which is sufficient to remove the gears, synchro hub and baulk rings. The pinion double taper roller bearing which is held by the notched locking nut should be left intact as this requires the use of more special tools to which we do not feel most owners will have ready access. The services of a press may be required in order to carry out the partial dismantling necessary to remove the baulk rings although if properly supported to the shaft may be driven out of the synchro hub with a heavy soft faced mallet.

22 First remove the circlip from the end of the shaft. The inner race of the needle bearing together with 4th gear may then be driven or pressed off together. Support the gear and then press or drive out the shaft.

23 Remove the spacer spring and then take off the other circlip round the shaft.

24 Third gear, the roller bearing, 2nd gears and 1st/2nd gear synchro hub and baulk rings may then be taken off in that order.

25 The synchro hub assemblies should be handled with care to prevent them coming apart inadvertently. It is important that if the centre hub and outer sleeve are separated that they be refitted in the same relative position. Some hubs have marks etched on each part to aid reassembly, so before anything else examine them on both sides for such marks. If none can be found make some of your own with a small dab of paint to ensure reassembly in the same position. To dismantle the hubs first lift out the spring retaining clip on each side. Then carefully slide the sleeve from the hub taking care not to drop and lose the three sliding keys.

26 Do not remove the selector fork rails from the gear carrier casing unless inspection indicates that there is something wrong with the detent balls and springs.

#### 4 Inspection for wear in transmission components

1 As mentioned in the introduction to this Chapter the degree of wear in the components will to a large extent dictate the economics of repair or replacement with a new unit. If the crownwheel and pinion is obviously badly worn, resulting in

noise and significant backlash, then it is possible that this may be repaired alone for approximately half the cost of a new unit provided that is the only major complaint. Such work is not within the competence of the average owner and this manual does not cover it.

2 Having been able to obtain the use of a press it is possible to remove all baulk rings for examination. The grooved taper face of the ring provides the braking action on the mating face of the gear wheel cone and if the ridges are worn the braking or synchro action will be less effective. The only way to determine the condition effectively is by comparison with new parts. As the parts are relatively cheap it is considered foolish not to renew them all anyway once the gearbox is fully dismantled. As a guide, when a baulk ring is fitted over its cone on the gear wheel there should be a minimum gap of 0.6 mm (0.024 inch) between the baulk ring and the gear teeth. The normal gap is 1.1 mm (0.043 inch) so it is obvious that if the gap is near the lowest limit new rings should be fitted. When obtaining new baulk rings make sure that you get the Parts Store to identify and mark each one according to its appropriate gear. Modifications have taken place and although the new ones will still fit and work they are not necessarily identical to the ones you take out. So if you muddle them up you could get problems. They are also not all the same in the set - some have wider cut-outs for example. So mark the new ones you get carefully.

3 Two types of bearings are fitted - ball and needle roller. As a rule needle roller bearings wear very little, not being subject to end thrust of any sort. Check them in position and if there are signs of roughness then they should be renewed. If any bearing should feel the slightest bit rough or show any sign of drag or slackness when revolved then it should be renewed. The double taper roller bearing should be similarly checked. If there is any sign of roughness or endfloat then this is a task for a specialist. If this bearing is needing renewal the condition of the pinion gear and crownwheel must be very carefully examined. Once these need renewal then the setting of the whole box is altered and clearances and shims have to be recalculated and changed.

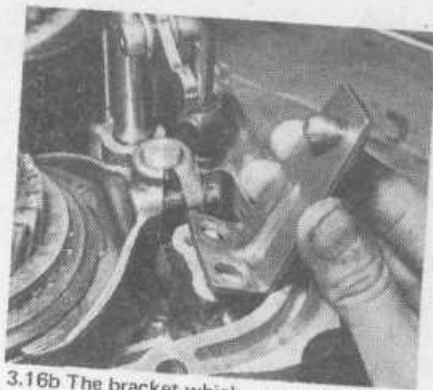
4 The teeth of all gears should be examined for signs of pitted mating surfaces, chips or scoring. It must be appreciated that if one gear is damaged then its mate on the other shaft will probably be as bad and that one way or another a new pair of gears will be required.

5 The synchro hubs should be assembled for checking. It is important that there is no rock or backlash on the splines between the inner hub and outer sleeve. When the baulk rings are being renewed it is good policy to renew the three sliding keys and their locating spring rings as well. The keys fit into the cut-outs in the baulk rings and are subject to wear and the springs weaken with time.

6 One of the most critical parts of the Volkswagen gearbox is the operation of the selector forks. The two forks run in grooves in the outer sleeves of the synchro hubs and if the clearance of the forks in the grooves is excessive then there is a likelihood of certain gears jumping out. The clearance of the fork in the groove should not exceed 0.3 mm (0.012 inch) (photo). Clearance in excess of the maximum could be due to wear on the fork or in the groove or both. It is best therefore first of all to take the forks along to the spares supplier and ask him to compare their thickness with new ones. If the difference in thickness is not enough to compensate for the excess gap between fork and hub groove then the hub assembly will need replacement as well. This is an expensive item but as the gap is somewhat critical there is no alternative. Much depends on the total degree of wear.

7 The selector rails on which the forks are mounted need not be removed from the casing. A certain force is needed in order that they overcome the pressure of the spring loaded ball in the groove. This can be measured with a spring balance hooked on to the end of each selector fork. If the required pull is significantly outside the range of 15-20 kgs (33 - 44 lbs) then it is advisable to check the detent springs and balls. To do this push the selector rods right out of the casing. This will release the ball and spring but to get the springs out it is necessary to prise out the

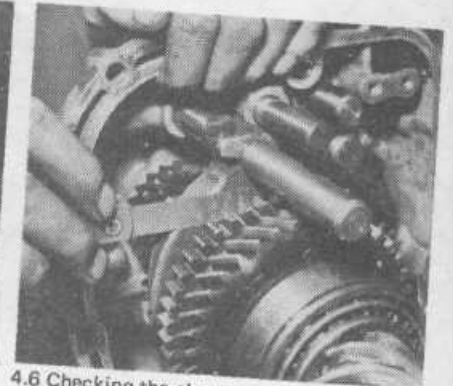




3.16b The bracket which supports the reverse selector cross shaft is adjustable and must be marked before removal



3.18 As a last resort the pinion shaft can be driven out this way but be very careful



4.6 Checking the clearance of the fork in the groove

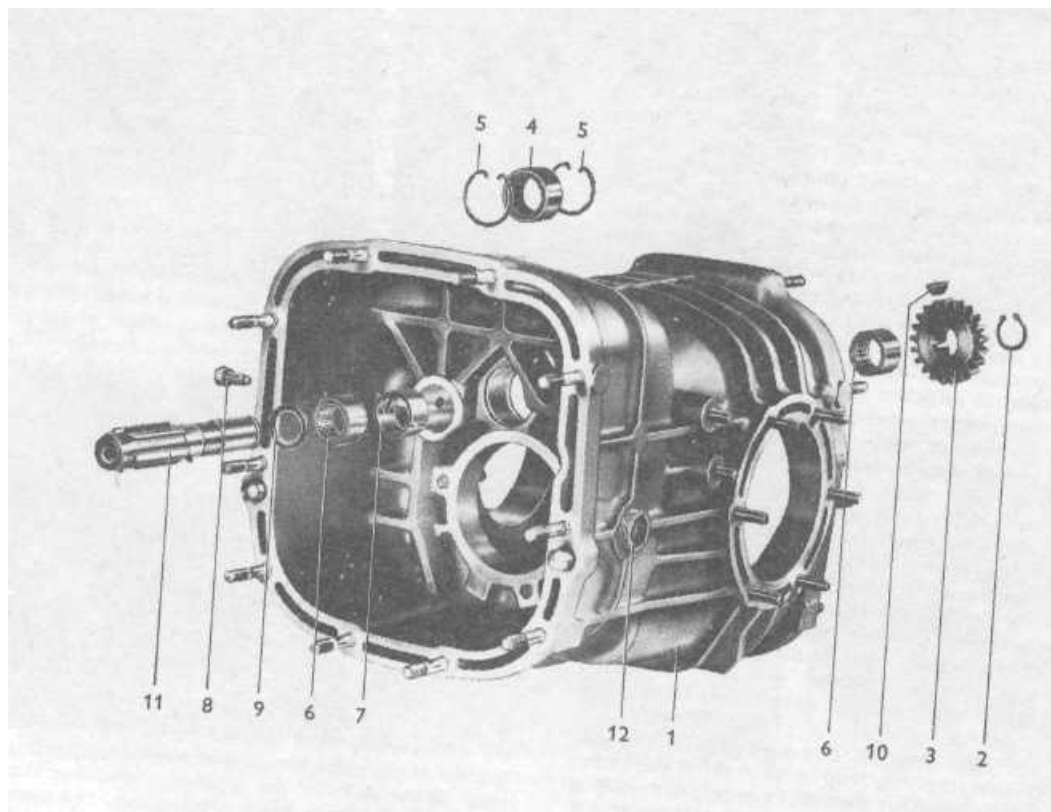


FIG 6.4. MAIN CASING - BEARING AND REVERSE GEAR SHAFT (Sec 5c)

- |                      |                                |                 |                              |
|----------------------|--------------------------------|-----------------|------------------------------|
| 1 Casing             | drive shaft                    | 7 Spacer sleeve | 11 Reverse gear shaft        |
| 2 Circlip            | 5 Circlip                      | 8 Locking screw | 12 Oil filler and level plug |
| 3 Reverse drive gear | 6 Needle bearing reverse shaft | 9 Thrust washer |                              |
| 4 Needle bearing     |                                | 10 Woodruff key |                              |



plastic plugs from the drillings opposite. Before doing this make sure you obtain some new plugs to drive in when reassembling. Check the spring free length which should be 25 mm (1 inch). If less than 22 mm they should be changed. The balls should be free from pitting and grooves and the selector rods themselves should not be a sloppy fit in the bores. The detent grooves in the rails should not be worn. When the rails are removed do not lose the interlock plungers which fit between the selector rod grooves.

9 Examine all parts of the casing for signs of cracks or damage, particularly near the bearing housings and on the mating surfaces.

10 It should not normally be necessary to completely wash all the gearbox components in fluid. Wipe components on clean cloth for examination. In this way the likelihood of dry spots during the first moments of use after reassembly are minimised. The casing itself should be thoroughly washed out with paraffin and flushed afterwards with water. Do not leave the needle roller bearings in position when doing this.

## 5 Transmission reassembly - general

Spend time in preparing plenty of clean, clear space and if your work bench is rough cover it with hardboard or paper for a good non-gritty surface. Do not start until you have all the necessary parts and gaskets assembled and make sure that all the ones you have obtained are going to fit. Gasket sets often contain items covering a variety of models so you will not need them all - this is why it helps to keep the old gaskets you take off until the job is eventually finished.

### 5A Input shaft - reassembly

1 First reassemble the input shaft, beginning by putting the needle roller cage for 3rd gear in position on the shaft. Then put 3rd gear with its matching synchro ring onto the roller bearings with the cone towards the front end of the shaft.

2 The 3rd/4th gear synchro hub assembly goes on next. This has to line up with the key in the shaft. Once the keyway in the centre part of the hub is lined up with the key in the shaft the hub can be driven on using a suitable piece of tube and heavy hammer. There are three very important points to note when doing this. Make sure that the hub is on the right way round - some models have a groove in the outer sleeve 1 mm deep and this must be towards the front end of the shaft. If there is no indication then you may put the hub on either way round. Secondly, make sure that you only drive the centre part of the hub. Otherwise it will come apart and have to be reassembled. Thirdly, the slots in the baulk ring must be lined up with the keys in the hub. This is best done by someone holding the baulk ring in position with the keys whilst the hub is driven on the final amount. Be careful not to trap any fingers!

3 Next the inner race for the 4th gear needle roller bearing has to be driven on to the shaft in the same manner that the hub was driven on before it. Drive it right down to the hub. Then replace the needle roller cage followed by the baulk ring and 4th gear. The baulk ring also has the three cut-outs which engage with the sliding keys in the hub.

4 Finally, place the thrust washer on the end of the shaft.

### 5B Pinion shaft - reassembly

1 As pointed out earlier, the pinion shaft has been dismantled only as far as the pinion bearing which has been left in position (photo). If this bearing has been renewed then the gearbox and final drive will need resetting and this is a skilled job requiring special equipment and a selection of special shims.

2 The first 'loose' item therefore which goes behind the pinion

is the shim (if any) controlling endfloat. The endfloat is measured by a feeler gauge after the 1st gear and synchro hub have been fitted. The measurement is between the face of the gear and the thrust washer which is locked in front of the pinion taper roller bearing. The measurement range is from 0.10 - 0.25 mm/0.004 - 0.010 ins

3 If the gap is outside this range then the shims must be altered to suit.

4 Now put 1st gear (the largest one with helically cut teeth) in position on the needle roller bearings with the cone face of the synchro pointing away from the pinion gear (photo).

5 Select the 1st gear baulk ring and place it over 1st gear and then replace the 1st and 2nd gear hub over the splines on the shaft with the selector fork groove of the outer sleeve facing towards the front end of the shaft (photo). Make sure that the three cut-outs in the synchro ring engage with the sliding keys in the hub before pushing the hub fully home. Remember that the baulk rings for 1st and 2nd gears are slightly different. The 1st gear ring has narrower cut-outs than those in the 2nd gear ring.

6 Now check the 1st gear endfloat as mentioned in paragraph 2.

7 Put the 2nd gear baulk ring in position in the hub so that the slots engage with the sliding keys.

8 Replace 2nd gear with the cone towards the hub (photo).

9 Third gear, which has a large bearing boss integral with it, should now be replaced with the needle roller bearing which fits together with 3rd gear, inside 2nd gear (photo).

10 Next fit the circlip on the shaft retaining third gear in position (photo).

11 The clearance between this gear and the circlip should be 0.10 - 0.25 mm/.004 - .010 ins. If the gap is outside this range then a circlip of different thickness is necessary to correct it.

12 Next fit the spacer spring, 4th gear and the inner race of the roller bearing (photo).

13 In order to drive the race and gear onto the shaft select a tube or socket of the required diameter. When the race is nearly fully on, put the circlip in position also and drive that on with it until it reaches the groove (photo).

### 5C Main casing - installing bearings and reverse gearshaft

1 Two sets of needle roller bearings are fitted in the main casing. One set comprises two roller cages and a spacer between and in this the reverse drive shaft runs. Drive one cage into the casing with a socket on an extension or suitable drift so that it is flush with one end of the bore. The metal face of the needle cage end should face inwards. The spacer should then be inserted with its slot so lined up that it will engage with the locking bolt which is screwed in through the side of the casing. Put the locking bolt in position and then drive the other needle roller bearing into the other end of the bore. Alternatively the bearings and spacer can be assembled to the shaft and put into the casing as an assembly (photo).

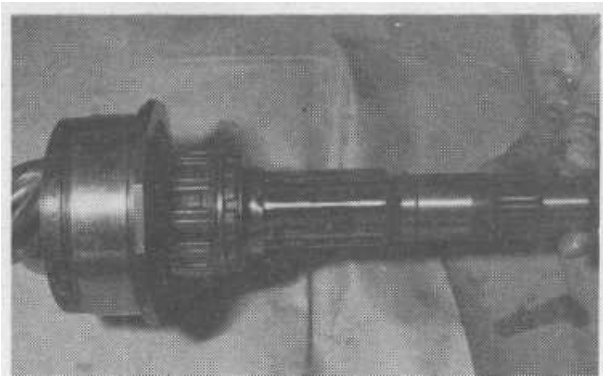
2 The gear may then be fitted to the other end and the circlip replaced (photo).

3 The other bearing supports the rear end of the input shaft front half and a circlip retains the bearing at each end.

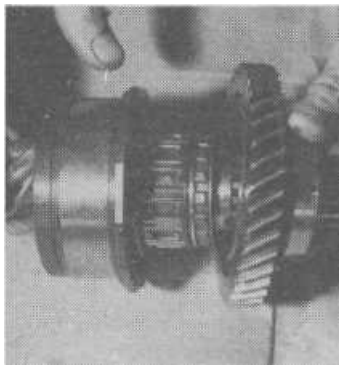
### 5D Gear carrier - fitting bearings

1 The needle roller bearing for the forward end of the pinion shaft should be lined up so that the hole for the locking screw corresponds with the recess in the bearing (photo). Tap it into position and fit the locking screw.

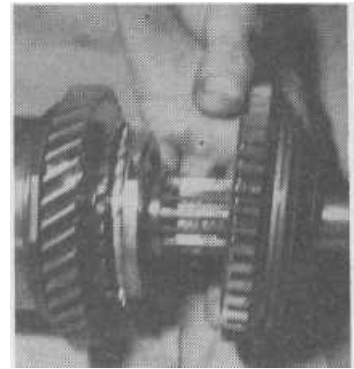
2 The special ball bearing with the flanged outer race should then be fitted into position from the outside of the *earner* casing (photo).



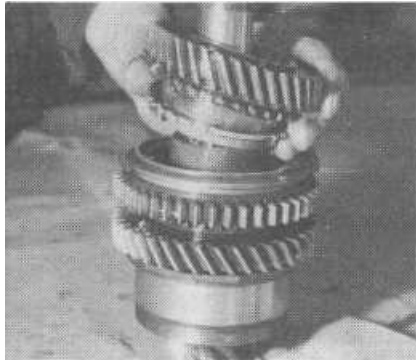
5.B1 The pinion shaft assembly



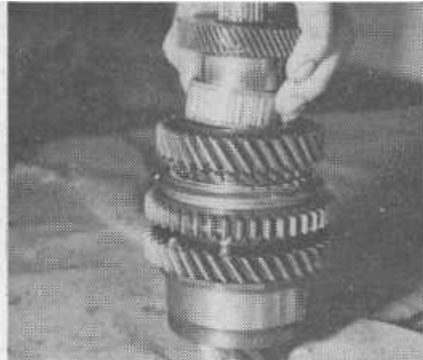
5.B4 Fitting first gear on the pinion shaft



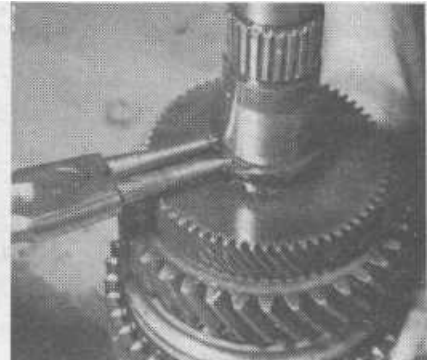
5.B5 Fitting 1st/2nd gear clutch hub



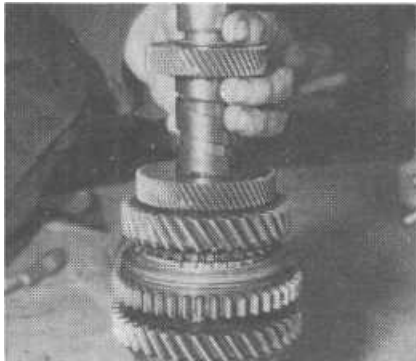
5.B8 Fitting 2nd gear and baulk ring



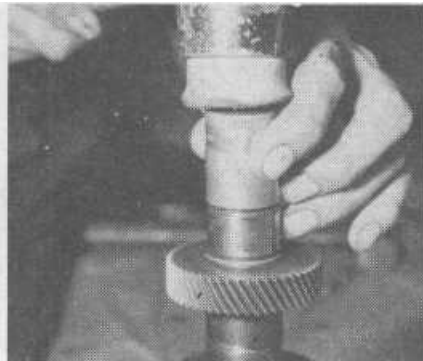
5.B9 Fitting 3rd gear and roller bearing



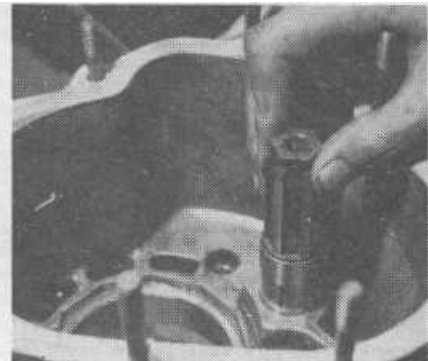
5.B10 Fit 3rd gear retaining clip



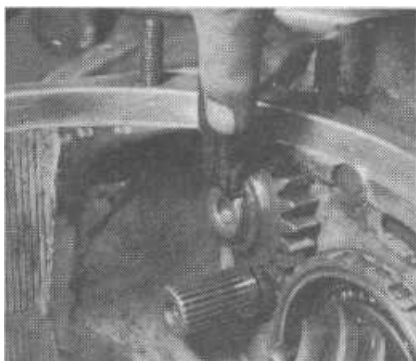
5.B12 Fit the spacer ring, 4th gear and the inner bearing race



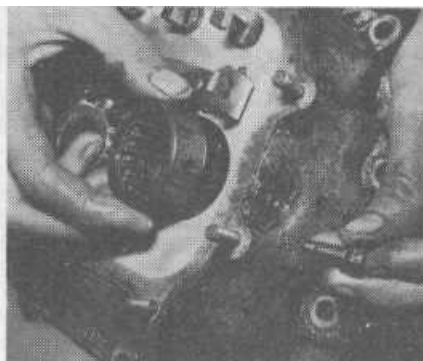
5.B13 Driving on the bearing race and circlip



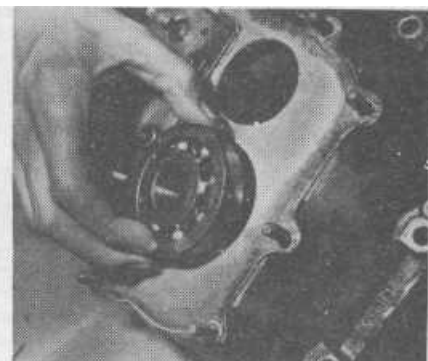
5.C1 Installing reverse gear drive shaft



5.C2 Fitting the gear and circlip



5.D1 Fitting the roller bearing for the pinion shaft



5.D2 Fitting the ball bearing with the flange

**5E Gear carrier - fitting shafts and selector forks**

- 1 It is assumed that the selector rails are in order (see Section 4, paragraph 7) and the forks are a correct fit in the hub sleeve grooves (Section 4, paragraph 6).
- 2 Holding both shafts together put them into the bearings (photo).
- 3 The pinion shaft will once again be the problem as it is a tight fit in the bearing and will require driving on with a suitable tubular drift.
- 4 When both shafts are in position the dished washer and circlip should be refitted to the pinion shaft using another suitable tubular drift to drive the circlip on. Make sure it seats completely in its groove (photos).
- 5 Next assemble the selector forks to the correct rails making sure that they are lined up with the marks made (photo 3.13). The flats on the rails should also be in line with the clamp bolt holes (photo).
- 6 Reassemble the cross shaft brackets and the relay lever and post for reverse gear selector (photo). Do not omit the wave washer or the bracket (photo). Once again the line up marks must be correctly set.
- 7 The selector forks setting is critical. If the wear between the fork and groove is outside the limit the possibility of a gear not being fully engaged and jumping out is increased. If you can get the unit set up in a Volkswagen agent's jig you would be well advised to do so.
- 8 Provided you have clearly marked the fork positions on the rails there need be no difficulty either although if new forks or hubs have been fitted the markings may no longer apply.
- 9 If you have no marks and no jig facility handy proceed as follows. Start with the forks loose on the rails. Set all three selector rails in the neutral position, which is when the cut-outs in their ends all line up, and set the synchro hub outer sleeves also in neutral with the forks in position. Then tighten the fork clamp bolts sufficiently to prevent them slipping. Now push each selector in turn so that each gear is fully engaged. The outer sleeve of the appropriate synchro hub must move fully over the dogs of the baulk ring and gear in question. In each gear selected the fork must not bind in the groove. If difficulty is experienced in engaging a gear slacken the fork clamp nut and get the synchro hub sleeve fully into mesh and then retighten the fork clamp in position. Then move the selector back to neutral and into the opposite gear position. In all three positions there must be no semblance of pressure in either direction from the fork on to the groove in which it runs. When both forward speed selector forks have been correctly set tighten the clamp bolts to 18 ft lbs/2.5 mkg.
- 10 The sliding reverse gear and yoke can be attached to the relay lever next for setting purposes. It will tend to fall out of position because it is finally held by the reverse gear shaft in the main transmission casing.
- 11 To set this pinion first engage 2nd gear. Hold the pinion square and in this position it should be lined up midway between the straight cut teeth on the synchro sleeve and the helical teeth of 2nd gear on the input shaft (photo). Then move out of 2nd gear and shift into reverse. The reverse gears should mesh completely. Adjustment for this setting is by moving the relay lever post up or down.

**5F Gear carrier and shafts - assembly into casing**

- 1 The bearings and reverse gear idler shaft should be installed in the main casing.
- 2 See that the mating faces of the casings are clean, smear thinly with jointing compound and fit a new gasket, (photo)
- 3 The reverse sliding gear which is a loose fit in its yoke is the main item to watch. Make sure the chamfered ends of the teeth face the straight cut teeth on the gear hub and set it in position squarely (photo).

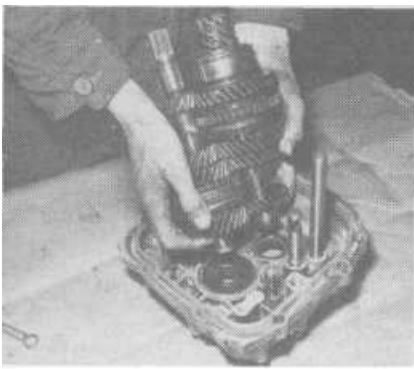
- 4 Lower the *earner* and shafts into the casing and guide the reverse sliding gear over the shaft in the casing. It may be necessary to hold the shafts and juggle the gear with a screw-driver to do this (photo).
- 5 When the carrier is fully down replace the nuts to hold it in position but do not tighten them fully.
- 6 Inside the casing replace the pinion shims followed by the circlip (photos).
- 7 Where three retainer plates hold the pinion bearing note that the two legs should bear equally on the bearing and the special nut fit into the counter sunk hole (photo).
- 8 Tighten the nuts to the correct torque of 22 lb ft (3.0 mkg) (photos).
- 9 Tighten the gear carrier nuts to a torque of 14 lbs ft (2 mkg).
- 10 Where the pinion is held by a locking ring the only way to tighten it correctly is with the special tool (VW 381/14). A torque of 160 lbs ft is required.

**5G Gear selector levers and cover - reassembly**

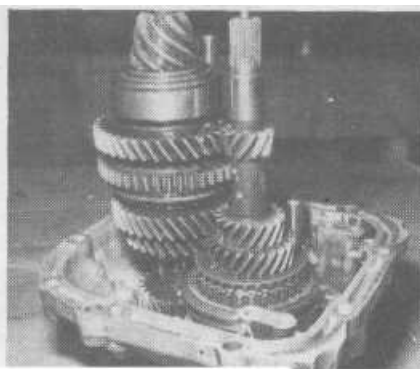
- 1 Reassemble the selector bar and pin (photo), (it will only fit one way round) and place a new gasket in position on the carrier casing (photo).
- 2 Engage the change lever into the ball joint in the selector bar and fit the selector cover in position (photos).
- 3 It is a good idea at this stage to select all gears in turn and make sure that the shafts turn freely in all gears.

**5H Final drive and bearings - replacement**

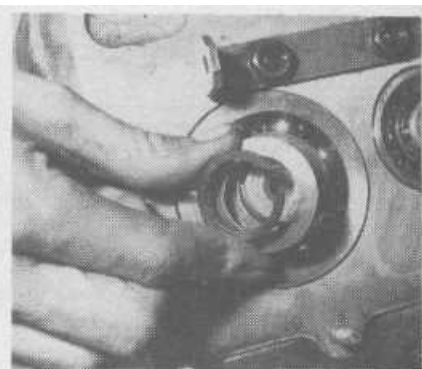
- 1 It is advisable to fit new seals in the side bearing covers (photo). Lever or punch the old ones out and fit the new ones carefully with the lip side facing inwards. Make a careful check to see they are the correct internal diameter. There are similar seals on some models which are fractionally larger and these will leak.
- 2 Renew the 'O' rings in the outer annular grooves of the bearing covers (photo).
- 3 If new bearings have to be fitted (necessitating driving the old ones off the differential casing and moving the outer races from the side cover) it should be borne in mind that the new bearings will require re-shimming in order to obtain the correct bearing pre-load and pinion gear backlash. It is most unusual for the taper roller bearings to need replacement other than as part of a complete rebuild. As mentioned earlier, the setting up of the differential to the correct clearances and pre-loads (which are essential if quiet running and long life are desired) is a skilled job requiring special measuring equipment designed for this particular transmission. It is assumed therefore, that the original bearings are being refitted.
- 4 Put the differential assembly into the casing - it will only go one way (photo).
- 5 Refit the shims (photo) and side bearing covers to each side (photo) taking care to line up the marks made on dismantling (photo).
- 6 Replace the cap nuts and tighten them to 14 lbs ft (2 mkg).
- 7 Replace the reverse gear/sleeve onto the input shaft (photo). The input shaft extension section should have the circlip in position behind the groove and the threaded stud should be screwed into the end.
- 8 Line up the extension shaft with the gear/sleeve (photo) and draw the sleeve back on to the extension. (You cannot get the extension and gear in position any other way).
- 9 Screw the extension shaft home and then back it off a fraction until the gear slides forward.
- 10 Refit the retaining circlip in its groove (photo).
- 11 Replace the spacer ring on to the splined side gear (photo), refit the driving flange (photo) and replace the circlip (photo).
- 12 Fit new sealing discs into the flange plate centres (photo).
- 13 Replace the clutch housing using a new gasket (photos).



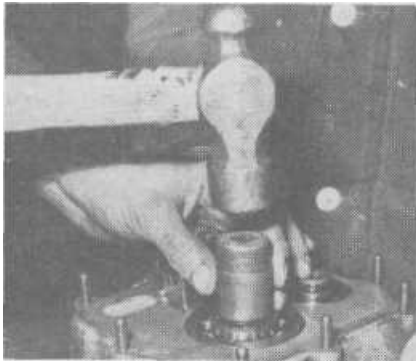
5E.2A Replacing the shafts in the bearings



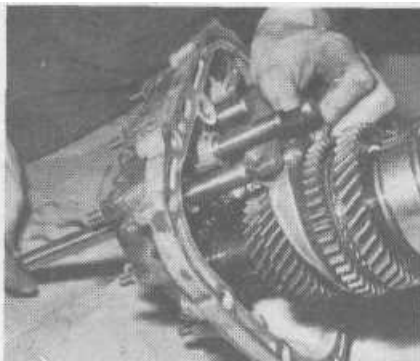
5E.2B The shafts in position



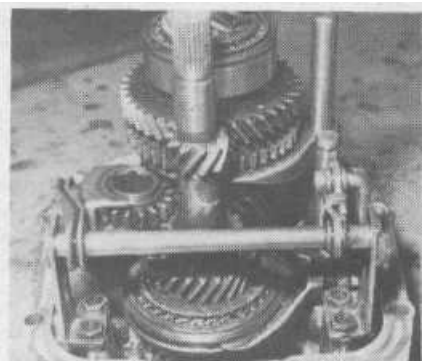
5E.4A Fit the dished washers and circlip



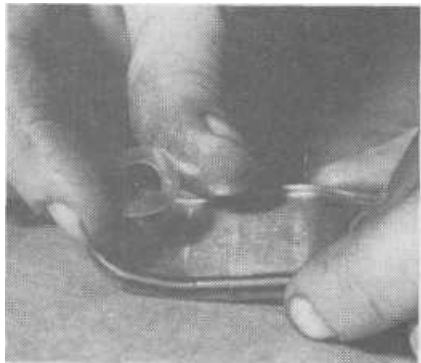
5b.4B Drive home the circlip onto the pinion shaft



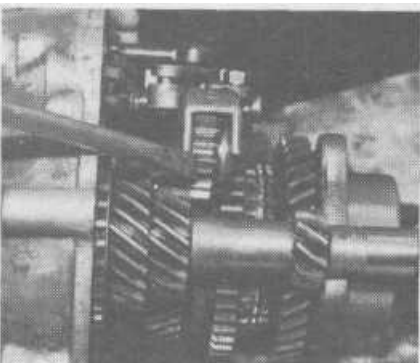
5E.5 Assemble the selector forks to the correct rails



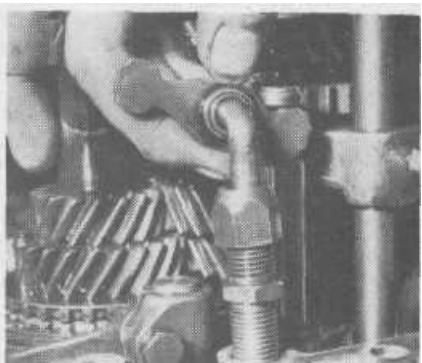
5E.6A The cross shaft brackets, relay lever and posts for reverse gear



5E.6B Do not omit the wave washer



5E.11A Assemble reverse sliding gear and yoke



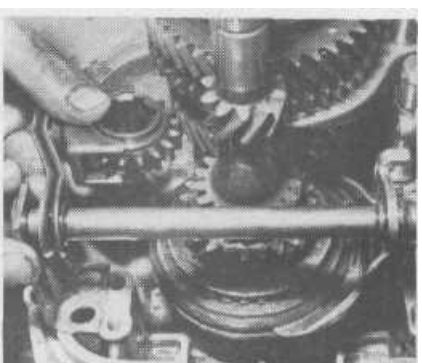
5E.11B Adjustment by moving the relay lever post up or down



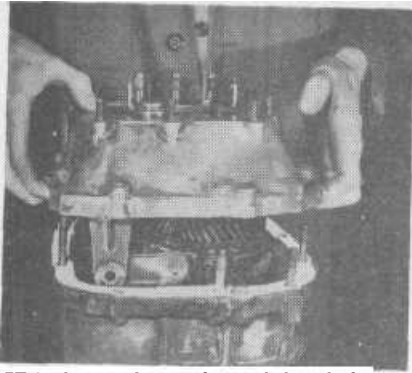
5F.2A Smear a thin film of jointing compound on the casing mating face



5F.2B and fit a new gasket



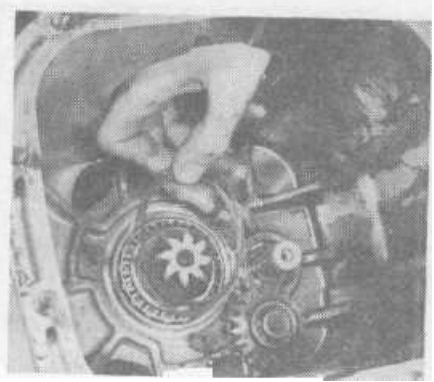
5F.3 Fit reverse gear firmly in its yoke



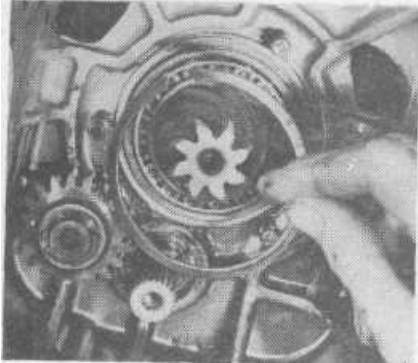
5F.4a Lower the carrier and the shafts into the casing



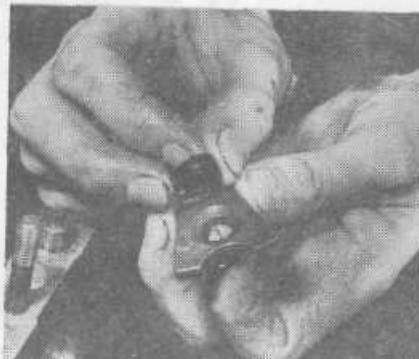
5F.4b It may be necessary to juggle the gear with a screwdriver to get reverse gear onto its shaft



5F.6a Replace the pinion shims



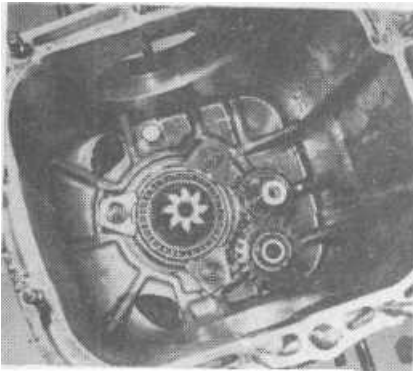
5F.6b followed by the circlip



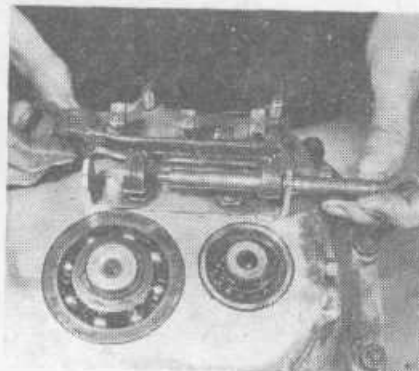
5F.7 The special nut fits into the countersunk hole



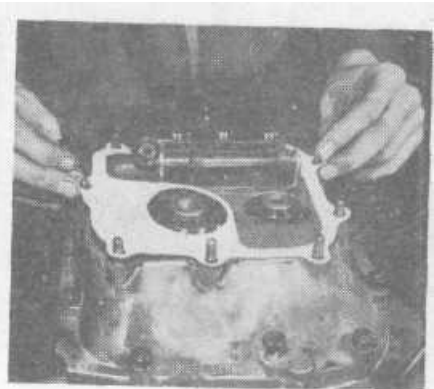
5F.8a Tighten the nuts to a torque of 22 lbs/ft



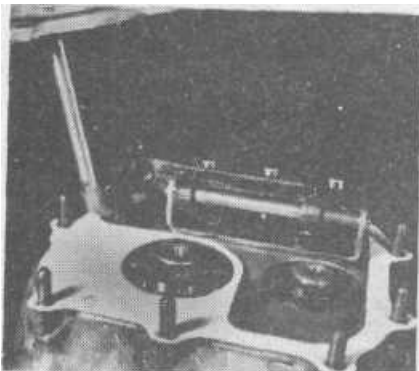
5F.8b Lugs correctly in position



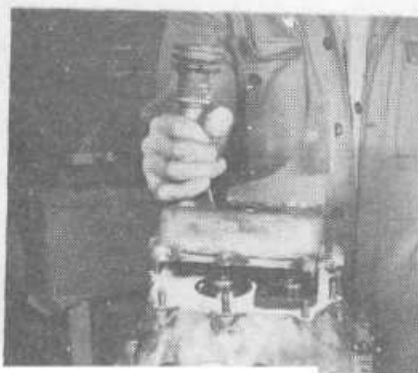
5G.1a Reassemble the selector bar



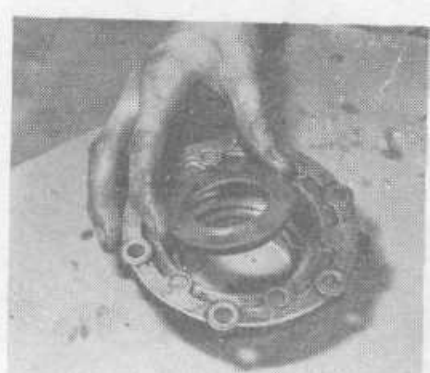
5G.1b fit a new gasket to the carrier casing



5G.2a Engage the change lever into the ball joint of the selector bars and ....

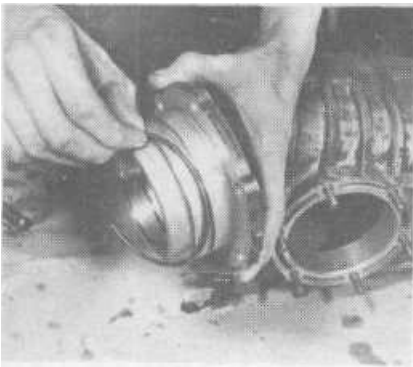


5G.2b .... fit the selector cover into position

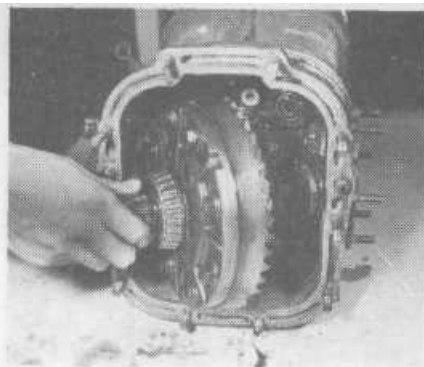


5H.1 Fit new seals to the side bearing covers

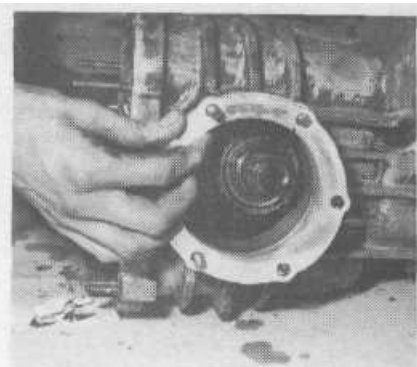




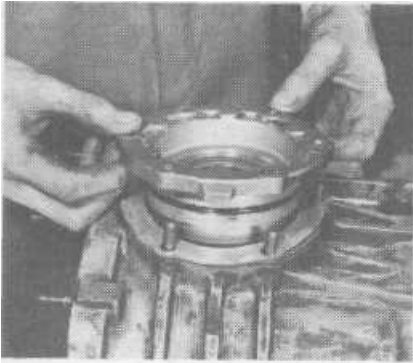
5H.2 Renew the 'O' rings on the bearing c<sup>o</sup>ve<sub>r</sub>



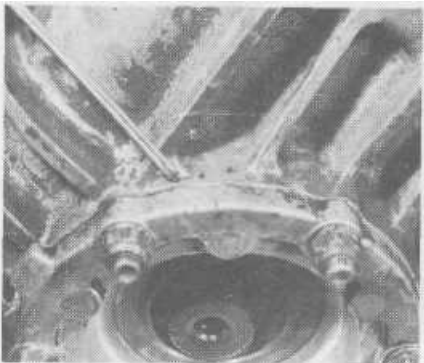
5H.4 Put the differential assembly into the casing



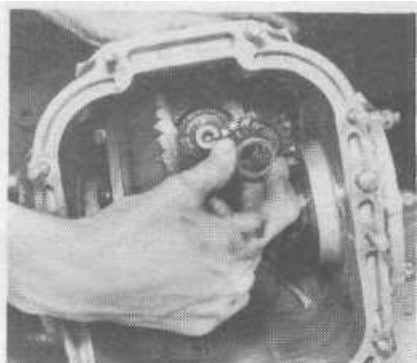
5H.5a Replace the shims ...



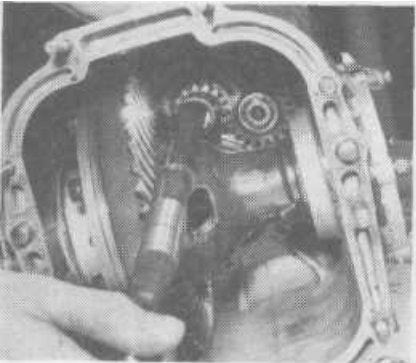
5H.5b .... and the side bearings



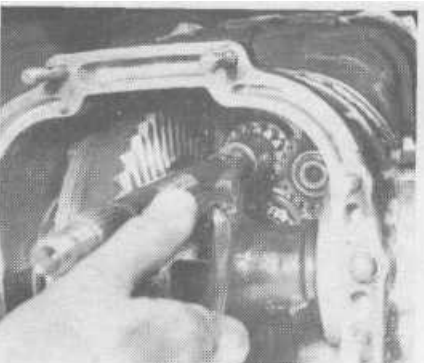
5H.5c check the marks made when dismantling



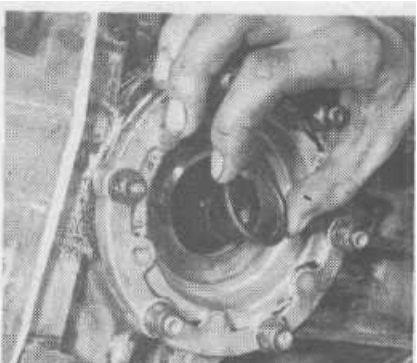
5H.7 replace the reverse gear sleeve onto the input shaft



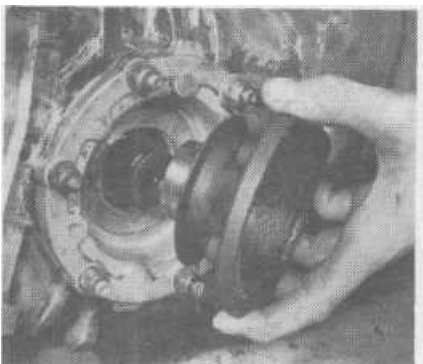
5H.8 Fit the extension shaft



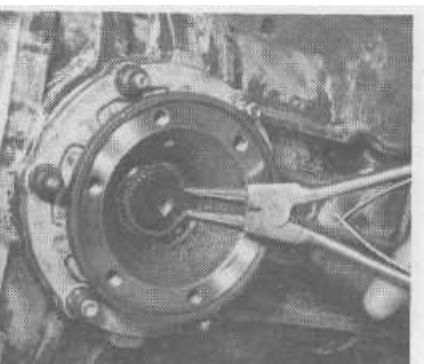
5H.10 Replace the circlip



5H.11a Replace the spacer ring ....



5H.11b .... followed by the driving flange..

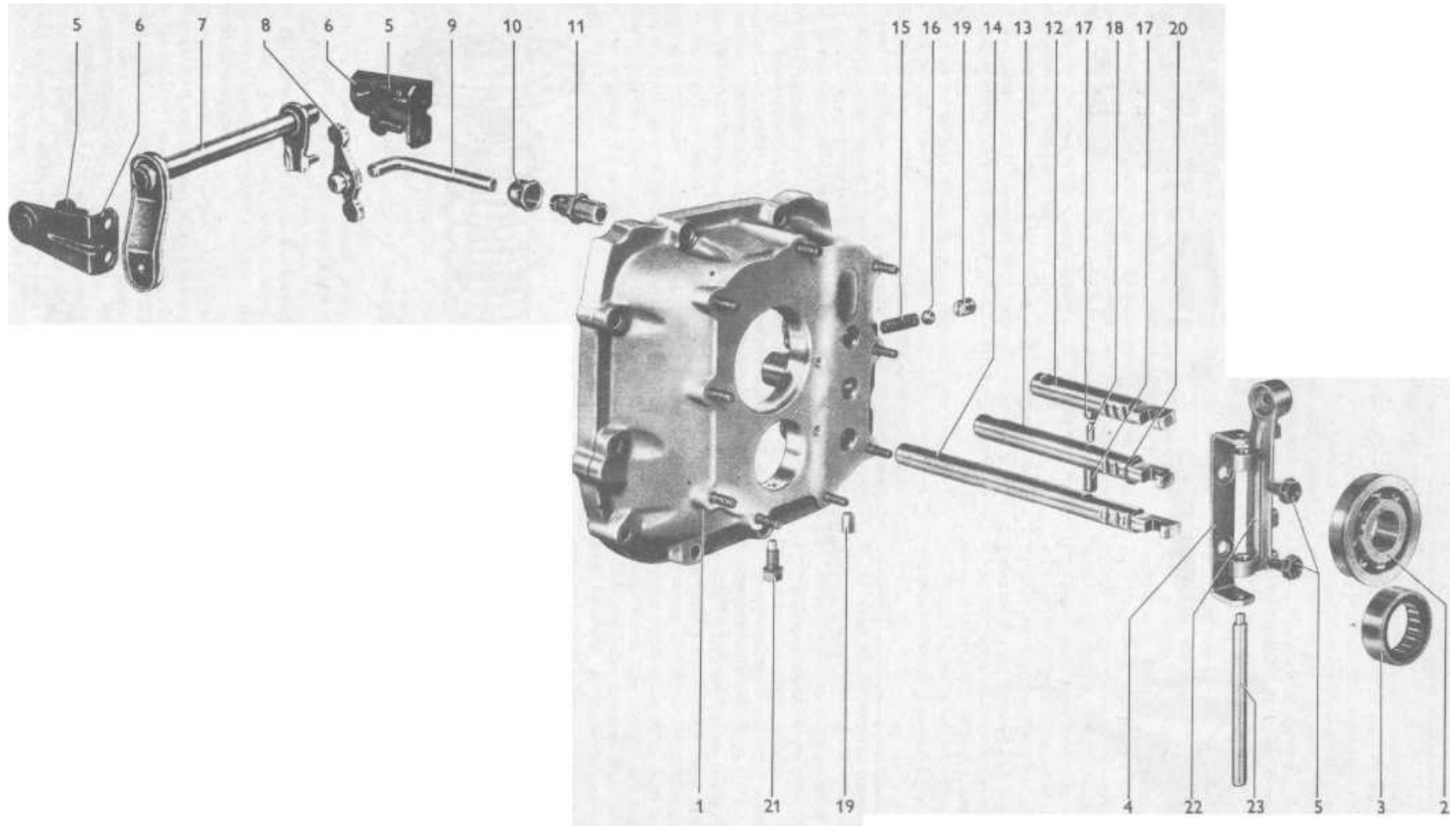


5H.11c .... and the circlip



5H.12 Fit new sealing discs





**FIG.6.5 GEAR CARRIER AND SELECTOR LEVERS - COMPONENTS (Sec 5G)**

- 1 Gear carrier
- 2 Bearing drive shaft
- 3 Needle bearing - pinion shaft
- 4 Support - shift lever

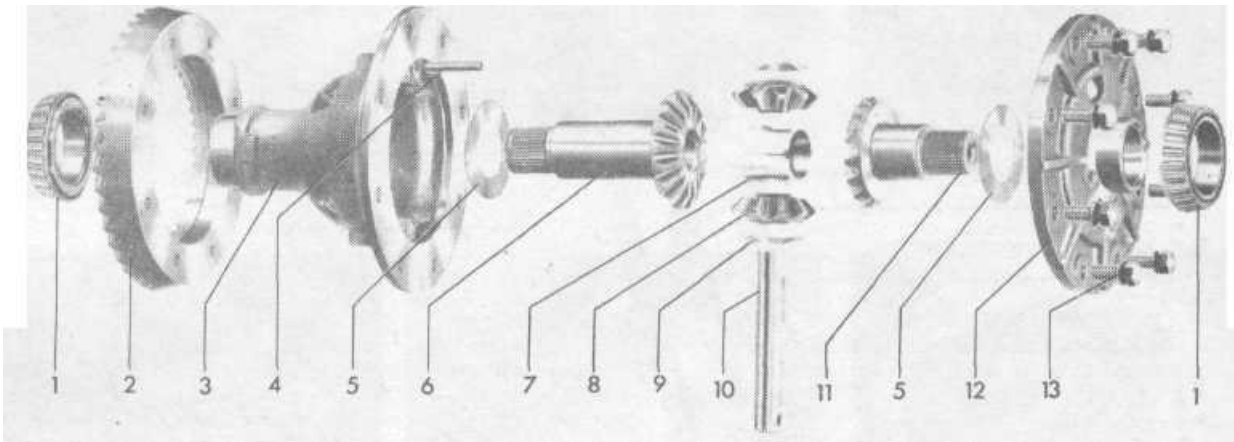
- 5 Screw
- 6 Bracket - relay shaft
- 7 Relay shaft
- 8 Reverse lever
- 9 Support

- 10 Union nut
- 11 Clamp sleeve
- 12 Selector rail. 3rd/4th gear

- 13 Selector rail - reverse
- 14 Selector rail - 1st/2nd gear
- 15 Detent spring

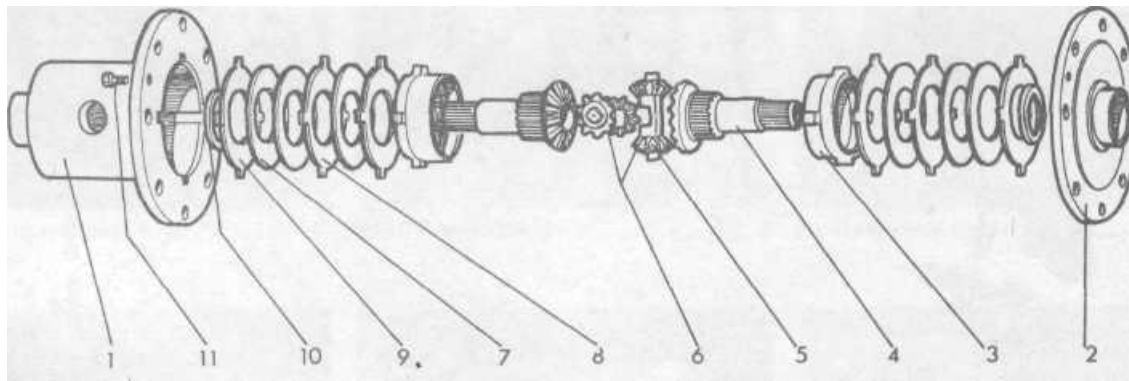
- 16 Detent ball
- 17 Interlock plunger
- 18 Intermediate plunger
- 19 Plug

- 20 Circlip
- 21 Lock bolt
- 22 Shift lever
- 23 Shift lever spindle



**FIG.6.6 DIFFERENTIAL ASSEMBLY (Sec 8)**

- |                             |                                     |                                      |                            |
|-----------------------------|-------------------------------------|--------------------------------------|----------------------------|
| 1 Taper roller side bearing | 4 Shaft retaining pin               | 7 Spacer sleeve                      | drive shaft, short         |
| 2 Crown wheel (ring gear)   | 5 Thrust washer                     | 8 Differential pinion                | 12 Housing end cover       |
| 3 Differential housing      | 6 Differential gear and drive shaft | 9 Thrust washer                      | 13 Bolt with spring washer |
|                             |                                     | 10 Pinion shaft                      |                            |
|                             |                                     | 11 Differential gear and drive shaft |                            |



**FIG.6.7 LIMITED SLIP DIFFERENTIAL - PLATE TYPE (Sec 9)**

- |                          |                        |                               |                          |
|--------------------------|------------------------|-------------------------------|--------------------------|
| 1 Housing                | 5 Pinion spindle       | 8 Outer splined plates        | 10 Thrust washer         |
| 2 Housing end plate      | 6 Differential pinions | 9 Dished outer splined plates | 11 Socket head cap screw |
| 3 Pressure ring          | 7 Inner splined plates |                               |                          |
| 4 Differential side gear |                        |                               |                          |

## 6 Synchromesh hub assemblies - dismantling, inspection and reassembly

1 Unless the transmission is the victim of neglect or misuse, or has covered very high mileages, the synchro hub assemblies do not normally need replacement. Until recently they could only be replaced as complete assemblies but it should be possible to obtain the inner or outer section as required.

2 When synchro baulk rings are being renewed it is advisable to fit new blocker bars (sliding keys) and retaining springs in the hubs as this will ensure that full advantage is taken of the new, unworn cut-outs in the rings.

3 When a synchro hub is dismantled, intentionally or accidentally, there are some basic essentials to remember:

- a) The splines of both parts wear into each other and provided neither is worn too far they should be kept matched if possible.
- b) Where the three sliding keys fit there is a recess in the centre of the spline on the outer sleeve (photo). It is essential, for correct operation, that these be lined up.
- c) Make sure that the sliding key retainer clips overlap on each side so that no key has the ends of both clips over it.

4 When examining for wear there are two important features to look at:

- a) The fit of the splines. With the keys removed, the inner and outer sections of the hub should slide easily with minimum backlash or axial rock. The degree of permissible wear is difficult to describe in absolute terms. No movement at all is exceptional yet excessive 'slop' would affect operation and cause jumping out of gear. Ask someone with experience for advice. If a new part is being fitted to worn part check the fit in each of the possible positions radially and also either way round to find the point of minimum play.
- b) Selector fork grooves and selector forks should not exceed the maximum permissible clearance of 0.3 mm (0.012 inch). The wear can be on either the fork or groove so it is best to try a new fork in the existing sleeve first to see if the gap is reduced adequately. If not, then a new sleeve is needed. Too much slack between fork and groove induces jumping out of gear. Where a hub also carries gear teeth on the outer sleeve these should, of course, be in good condition - unbroken and not pitted or scored.

## 7 Input shaft oil seal - renewal

1 It is possible that clutch contamination may be caused by failure of the oil seal that goes round the input shaft in the clutch housing. During the course of transmission overhaul it would be automatically renewed but it is possible to fit a new one with the transmission installed. The engine must be removed first.

2 With the engine removed detach the clutch release bearing from the operating forks and remove the sleeve from round the input shaft by undoing the three nuts.

3 The seal surrounds the input shaft where it goes through the casing. It can be dug out with a sharp pointed instrument provided care is taken to avoid damaging the surrounding part of the transmission casing.

4 Behind the seal is a further detachable sleeve with an oil return scroll in it and this too should be renewed.

5 Fit the new oil return sleeve and then the seal. Be careful not to damage the lip when passing it over the splines of the shaft and make sure it does not turn back when it reaches the part of the shaft on which it bears.

6 It should be driven into position squarely and a piece of tube is ideal for this put round the shaft (photo). If the seal should tip in the early stages of being driven in take it out and start again. Otherwise it may be badly distorted and its life will be shortened considerably.

7 The seal should be driven in until the outer shoulder abuts the casing.

## 8 Differential

1 The differential gear contained in the differential casing is not normally a do-it-yourself repair job. This is because failure is extremely rare and in circumstances of extreme wear as a result of either neglect or high mileages the whole assembly would need to be renewed anyway.

2 The function of the differential is to enable the driven wheels of the vehicle to rotate at different speeds when the car is turning and the outer wheel is obliged to travel in a wider arc than the inner wheel. Each drive shaft has a bevel gear at the inner end and these are meshed constantly together with two bevel pinions. The shaft on which both pinions are mounted is fixed into the differential casing.

3 The crownwheel, which takes the drive from the gearbox, is bolted to the differential casing. When the drive rotates the differential casing, the pinion shaft is carried round with it and the pinion gears therefore rotate the drive shaft gears.

4 If either drive shaft is slowed down, or stopped completely, the differential pinions rotate on their own shaft due to the speed difference between the drive shafts.

5 Under such circumstances the power must be transmitted through the shaft offering least resistance. In cornering this would be the outer wheel. When you have one wheel in a ditch the power always goes to that wheel!

## 9 Limited slip differential (cone and plate type)

A limited slip differential is fitted to vehicles where the terrain they have to cover requires both drive wheels to be able to give simultaneous traction.

Early models were fitted with cone type limited slip. Later models have the plate type.

Both types operate on the same principle. The side gears are connected by a friction type 'clutch' (either cone or plates) to the casing under moderate spring pressure. When the differential is called upon to function, such as when going round a corner on normal roads, the 'clutch' will slip and permit the normal differential, operation between the two drive shafts. This is not the case however, if power is applied. When the differential is in operation and power is imparted, there is a tendency for the pinion and side gears to separate. This forces the covers tighter onto the casing and locks the differential. On the plate type there are two sets of pinion gears. The shafts of these are located in grooves between pressure rings. When the differential forces occur the shafts ride up in the grooves and apply the pressure without reducing the mesh depth of the pinion and side gear teeth as happens on the cone type.

It should be understood that vehicles fitted with limited slip differential have unusual handling characteristics on hard surfaced roads and their cornering reactions take some getting used to. The locking mechanism will operate on sharp turns if much power is used and this can have disconcerting effects.

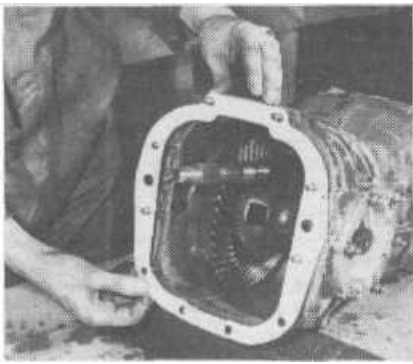
A further point regarding vehicles fitted with limited slip differentials is that the differentials wear out more quickly. In all conditions where there is a difference between the driving wheel speeds the friction plates are working against each other to a certain extent. Thus their surfaces are subject to frictional wear.

Special oil is required for transmissions fitted with limited slip differential.

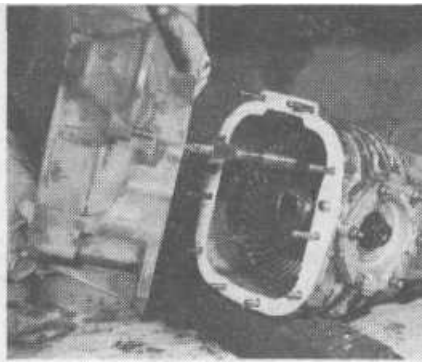
## 10 Gear change lever and linkage

1 The change lever and connecting rods are of necessity long. The rod joints and bushes may wear after considerable mileage and when they become sloppy the changing of gears may be difficult as a result.

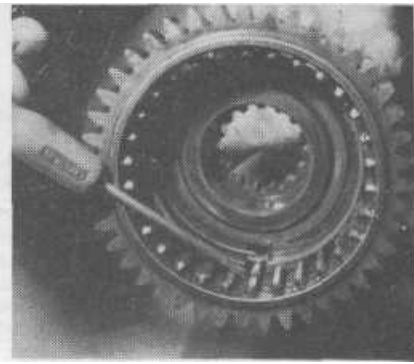
2 The gear lever can be adjusted to provide the proper engagement of gears after either the transmission or change lever mechanism has been disturbed.



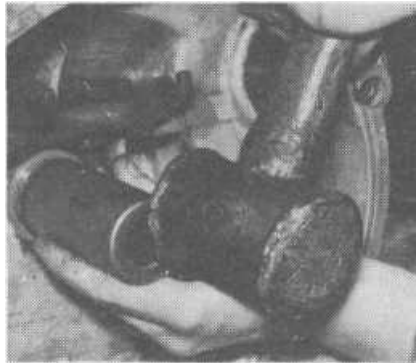
5H.13a Fit a new gasket ,



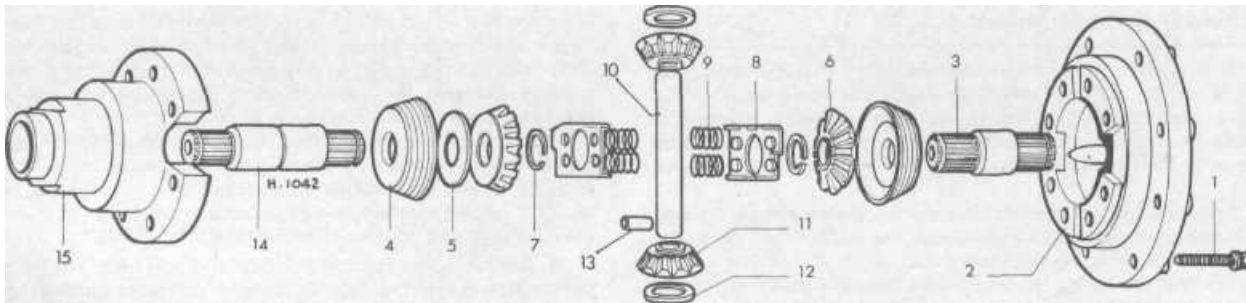
5H.13b .... and replace the clutch housing



6.3b The indented splines in the sleeve must line up with the sliding keys



7.6 Driving a new seal into position



**FIG.6.8 LIMITED SLIP DIFFERENTIAL - CONE TYPE (Sec 9)**

- 1 Housing bolt
- 2 Cover
- 3 Shaft - short
- 4 Friction cone

- 5 Adjusting shim
- 6 Side gear
- 7 Circlip
- 8 Locating plate

- 9 Spring
- 10 Pinion shaft
- 11 Pinion
- 12 Thrust washer

- 13 Pin
- 14 Shaft long
- 15 Housing

When the lever is in 2nd gear position it should be exactly vertical with the cranked upper section inclined at about 30° to the rear.

Sideways movement measured at the lever knob, with a gear engaged should not exceed 35 mm. In neutral it should not exceed 70 mm. If it is more than this it indicates that there is excessive wear in the linkage somewhere.

3 Adjustments can be made to the gear lever position by slackening the two bolts in the mounting bracket at its base. Engage second gear first and then loosen the bolts. Depress the clutch pedal and then align the lever into the correct position. Under the bracket there is a stop plate (for reverse gear). Push this to the left until it touches the shoulder on the lever but does not move the lever. Tighten the mounting bolts. Move the lever to first gear. The line of movement should be exactly longitudinal, without any tendency to move diagonally. If there is

diagonal movement loosen the bolts again and turn the stop plate a little to correct it. Later models have lugs on the stop plate to avoid this misalignment possibility.

4 To remove the front section of the shift rod is not difficult but the rear section requires the gearbox to be removed first because the rod can only be taken out from the rear.

To remove front section remove the under tray, undo the square headed locking screw on the muff coupling and then draw the muff back. The front section of rod can then be drawn off the front mounting pin. The guide sleeve at the front end can be renewed. Use molybdenum grease (Castrol MS3) for lubrication. With the gear box removed the rear section can be drawn out complete with the coupling once the front bellows have been taken off and both couplings disconnected. The bushes on the rod and the inserts in the coupling can be renewed as required.

## 11 Fault diagnosis

It is sometimes difficult to decide whether it is worthwhile removing and dismantling the gearbox for a fault which may be nothing more than a minor irritant. Gearboxes which howl, or where the synchromesh can be 'beaten' by a quick gear change, may continue to perform for a long time in this state. A worn gearbox usually needs a complete rebuild to eliminate noise because the various gears, if re-aligned on new bearings, will continue to howl when different wearing surfaces are presented to each other.

The decision to overhaul therefore, must be considered with regard to time and money available, relative to the degree of noise or malfunction that the driver has to suffer.

Symptom	Reason/s	Remedy
Ineffective synchromesh	Worn baulk rings or synchro hubs	Remedy.
Jumps out of one or more gears (on drive or over-run)	Weak detent springs, worn selector forks, worn synchro hubs or all three	Dismantle and renew.
Noisy, rough, whining and vibration	Worn bearings, (initially) resulting in extended wear generally due to play and backlash	Dismantle and renew.
Noisy and difficult engagement of gear	Clutch fault	Examine clutch operation.

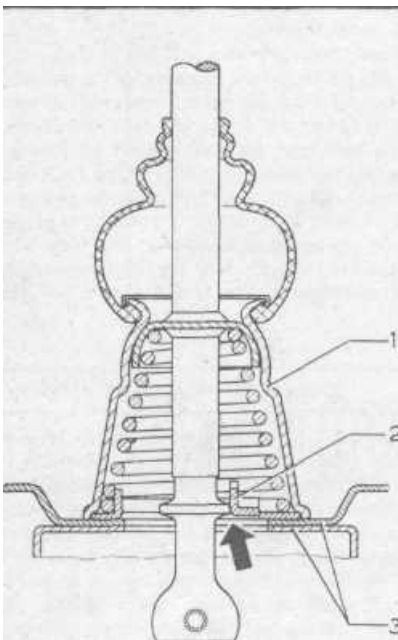
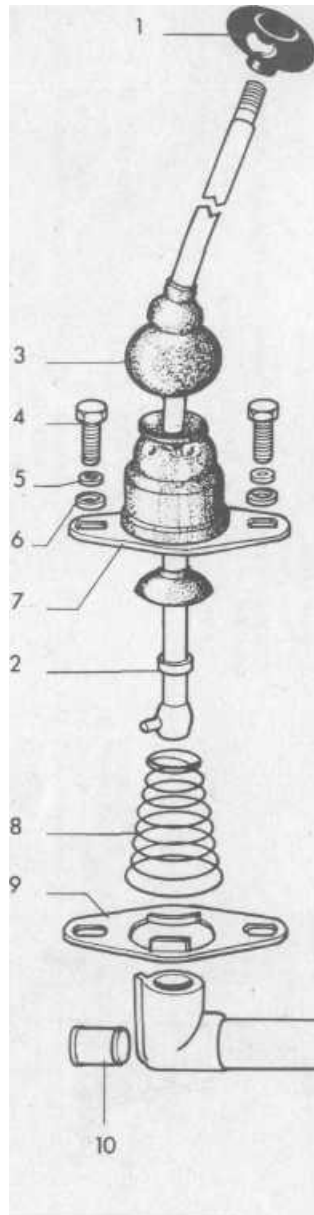


FIG.6.10 GEAR LEVER-LATERAL CROSS SECTION (Sec 10)

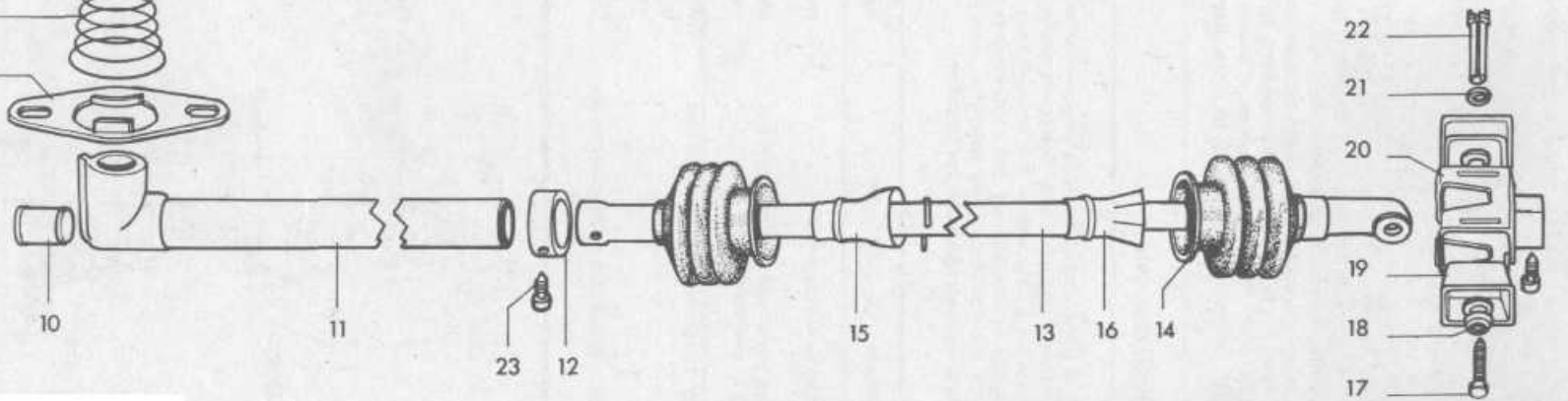
- 1 Mounting bracket
- 2 Stop plate
- 3 Floor panel

Arrow indicates lever shoulder against the stop plate in 2nd gear position.



**FIG.6.9 GEAR CHANGE LEVER AND RODS - COMPONENTS**  
(Sec 10)

- |                         |                       |
|-------------------------|-----------------------|
| 1 Knob                  | 13 Shift rod, rear    |
| 2 Gear lever            | 14 Bellows            |
| 3 Bellows               | 15 Bush, front        |
| 4 Mounting bracket bolt | 16 Bush, rear         |
| 5 Spring washer         | 17 Self tapping screw |
| 6 Washer                | 18 Locking cap        |
| 7 Bracket               | 19 Insert             |
| 8 Spring                | 20 Housing            |
| 9 Stop plate            | 21 Washer             |
| 10 Guide sleeve         | 22 Spring pin         |
| 11 Shift rod front      | 23 Lock screw         |





# Chapter 7

## Wheel shafts, drive shafts and universal joints

### Contents

General description. . . . .	1	replacement ... ..	3
Drive shafts - removal and replacement ... ..	2	Rear wheel shafts and bearings - removal and replacement	4
Constant velocity universal joints - removal, repair and			

### Specifications

Joint diameter - outer ring . . . . .	100 mm (3.94 in)	
Joint width - outer ring . . . . .	32 mm (1.26 in)	
<b>Torque wrench settings</b>	lb ft	m kg
Drive shaft flange cap screws . . . . .	25	3.5
Wheel shaft nut . . . . .	250	35
Brake back plate screws - Bottom 2 ... ..	33	4.5
- Top 1. . . . .	14	2.0

### 1 General description

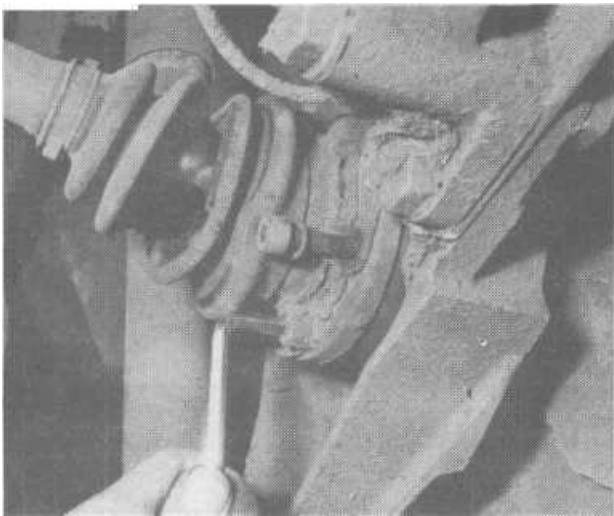
Unlike the swinging arm type of rear suspension which was fitted to all transporters up to 1967 when the 1600 engine was introduced, the drive shafts function solely to transmit the power from the final drive to the rear wheels. They do not form an integral part of the suspension system. The wheels themselves are supported on short 'quill shafts' which run in bearings in the suspension trailing arms. Each drive shaft has a constant velocity universal joint at each end and it is coupled to the final drive and wheel shafts by flanges secured with cap screws. Apart from improved road holding, this different design means that the axle shafts, wheel bearings and transmission may be removed for servicing separately with comparative ease. It should be remembered also that the rear wheel bearings are no longer lubricated by the transmission oil and require a lubrication service — although the intervals are well spaced (see Routine Maintenance).

### 2 Drive shafts - removal and replacement

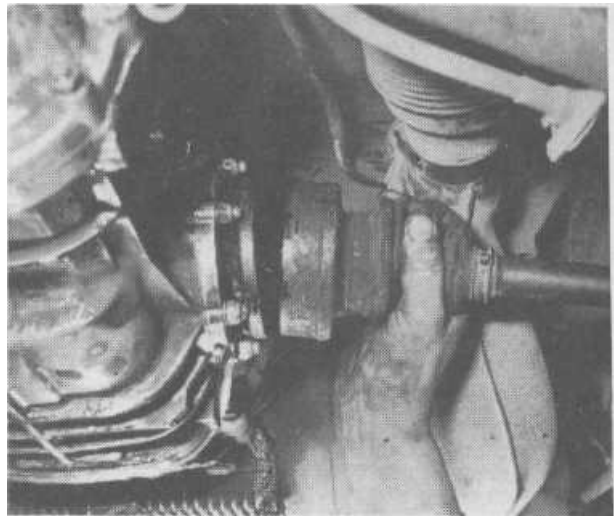
- 1 The drive shaft cap screws have either a splined or hexagonal socket. Whichever is used make sure that the key used to undo them is a perfect fit and of good quality hard steel (photo). If the sockets are damaged the greatest difficulty will be experienced in getting them out with any sort of key.
- 2 Before removing all the screws make sure that there are no accumulations of dirt nearby which could get into the joints. If any dirt gets in it will have to be cleaned out and the joints repacked with special molybdenum grease.
- 3 With all the screws removed the shafts may be taken away (photos).

### 3 Constant velocity universal joints - removal, repair and replacement

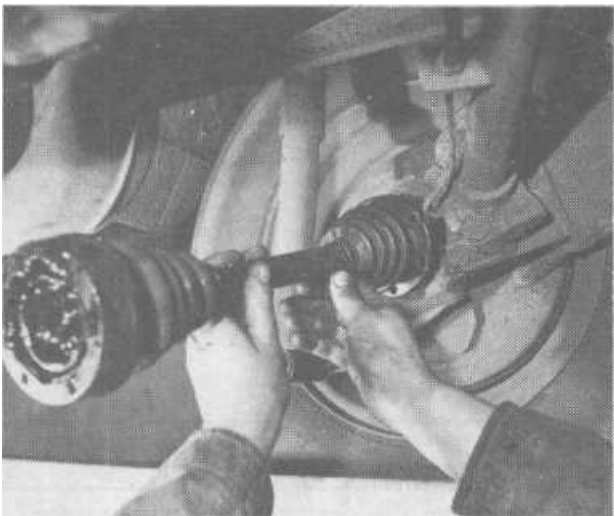
- 1 If the constant velocity joints have a noticeable amount of backlash they must be renewed completely. If the protective boot has split it is possible to dismantle and flush them, repack with grease and fit new boots (photos).
- 2 First remove the drive shaft as described in the previous section.
- 3 It is not necessary to remove the rubber boot. Simply tap off the metal cover from the joint which is a press fit. Before going any further clean off the face of the joint and note any forge marks on each of the components or any other features which will enable you to ensure they all face the same way again on reassembly. If none is apparent scratch some marks of your own.
- 4 Three different sorts of CV joints have been used since first introduction. The first type had no markings on them at all and had a press fit end cap which located in a groove on the inside of the outer ring. None of these type will normally be supplied as replacement. Later versions may have had a milled recess in the outer edge of the joint and in such versions the recess faces towards the drive shaft rubber boot or reassembly. Another type has a fine groove all around the outer ring near one edge. This ring goes towards the flange coupling.
- 5 To separate the joint from the shaft support the joint across the jaws of a vice with the shaft hanging down and prise out the end cap if fitted. Then remove the circlip from the end of the shaft. The shaft may then be driven down out of the joint. Discard the concave washer behind the joint.
- 6 Flush the joint out thoroughly, let it dry and then repack it with approximately 90 grams of Castrol MS3 Grease, working it well in from both sides (see photo 3.14a).
- 7 If the joint is being examined because of a split boot, which



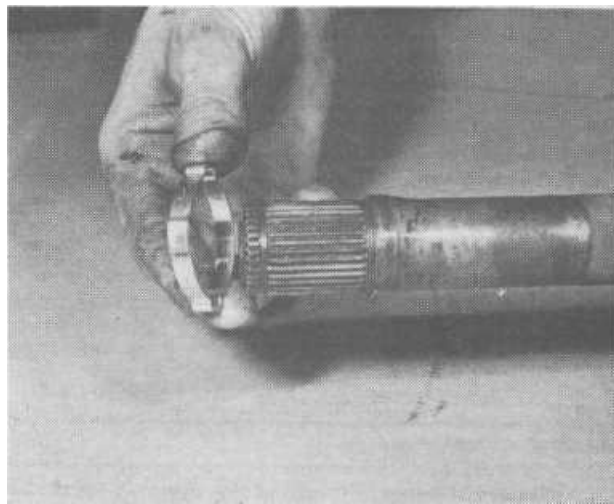
2.1 Undoing drive shaft cap screw, outer end. Note split rubber boot



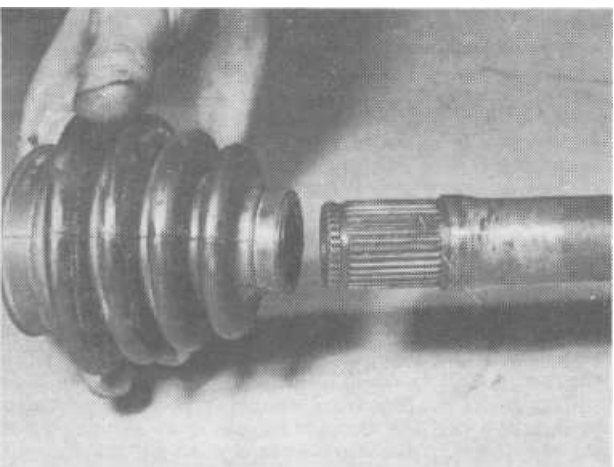
2.3a Removing the shaft from the gear box



2.3b Removing the shaft from the wheel hub



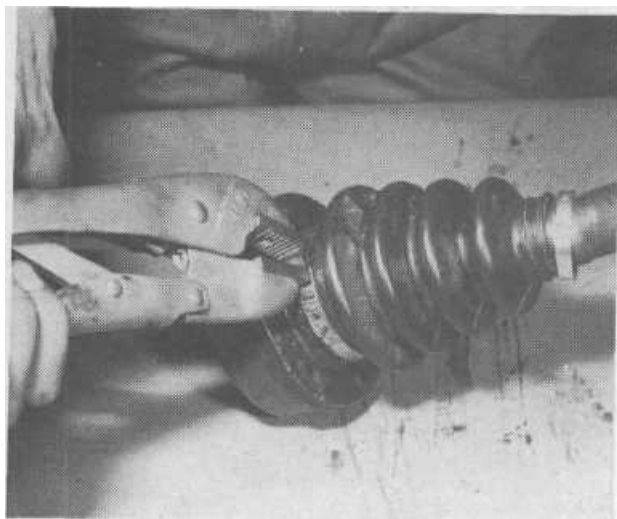
3.1a Fitting a new boot. First the inner circlip..



3.1b ...then the boot...



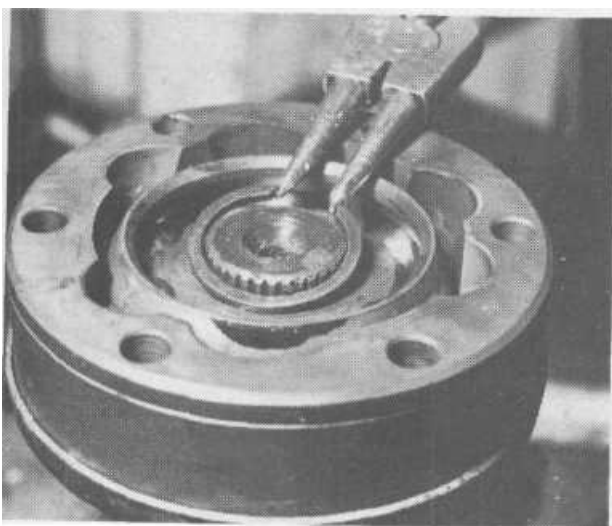
3.1c put the outer circlip on...



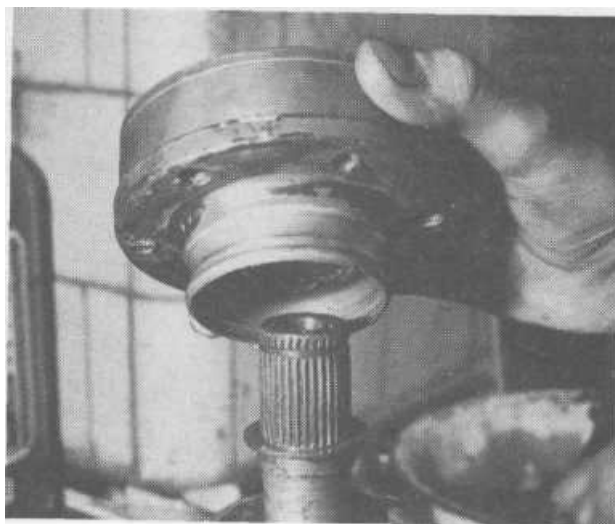
3.1 d ease the boot over the C.V joint and tighten up



3.5a Prise out the end cap



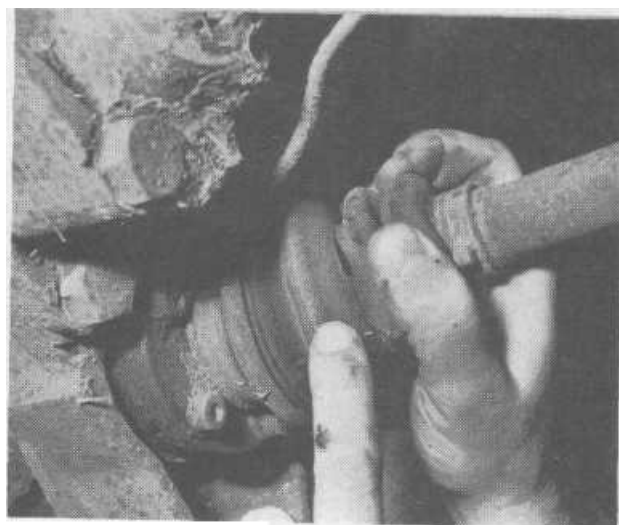
3.5b ... remove the circlip



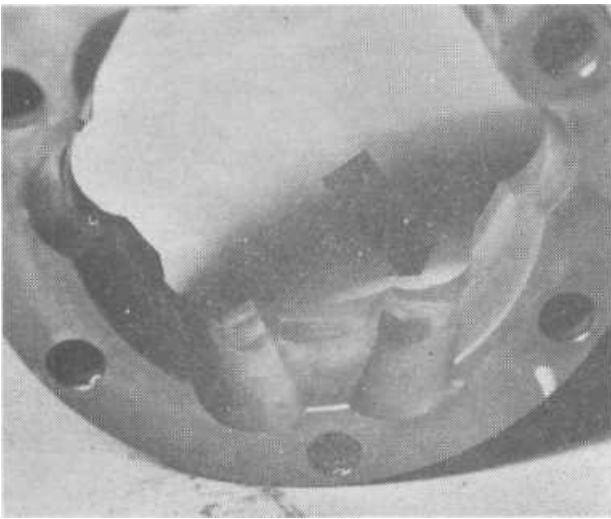
3.5c remove the C.V joint from the shaft



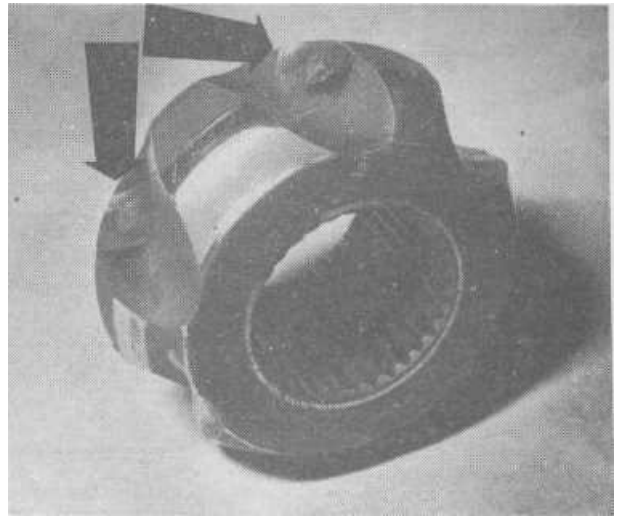
3.5d Discard the concave washer, if one is fitted, behind the joint



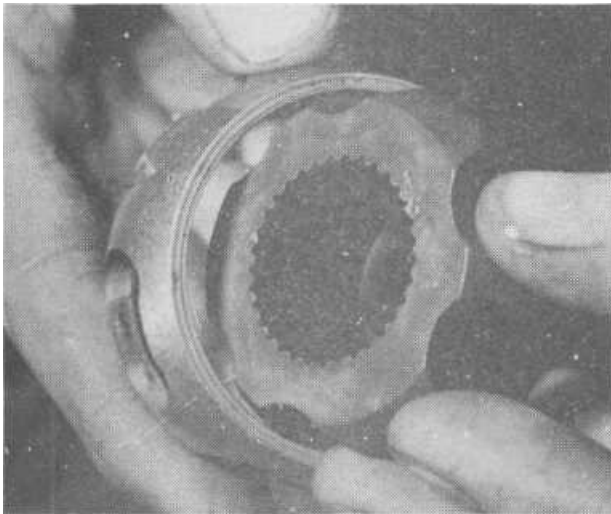
3.7a Examining a split boot



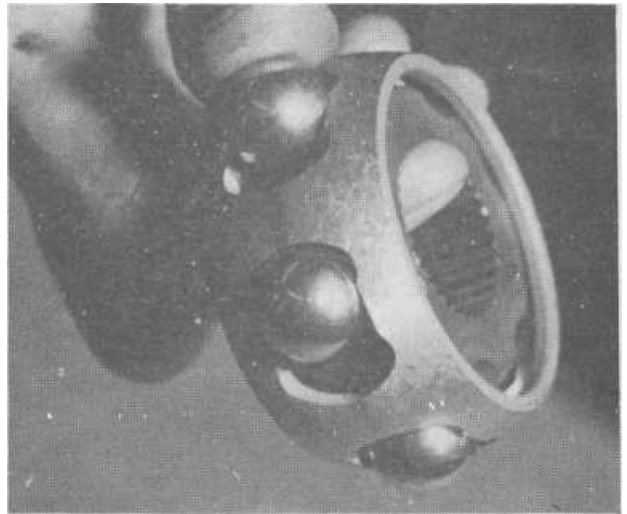
3.7b Damage (arrowed) on the joint outer ring



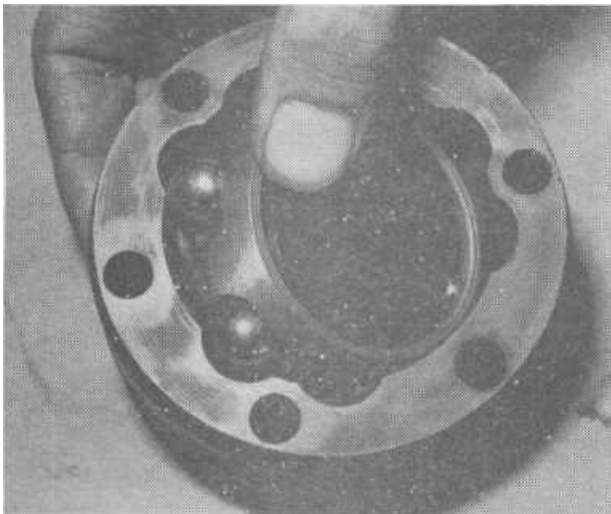
3.7c Damage (arrowed) on the joint hub



3.8 Constant velocity joint - placing the hub section in the cage



3.9 Fitting the balls into the cage



3.10 Fitting the hub, balls, and cage into the outer section

may have gone un-noticed for a long period and let in water and dirt, it may need careful examination to decide whether renewal is needed. The tracks in which the balls run should not be grooved or damaged at the edges in any way. The cage slots should not be wider than the steel balls. The balls themselves must be quite spherical and not pitted. If split boots are not rectified without delay and the proper lubrication of the joint is diminished damage soon occurs (photos). New joints are expensive.

8 If the inner cage of the joint is dismantled or falls apart it must be correctly reassembled. First fit the splined hub inside the ball cage — it will only go in if two grooves are lined up (photo).

9 Then press the balls into the cage. They should be a snap fit unless the cage is worn badly (photo).

10 Place the ball and hub assembly into the outer cage so that the chamfered edge of the hub splines will be in a position towards the shaft shoulder when the joint is eventually replaced on the shaft (photo). This means that it has to be the right way round in the outer cage because the outer cage goes on so that the protective boot assembly can be tapped back in position on the side away from the outer ring groove.

11 The concave washer should not be refitted.

12 Put the joint back on the shaft (photo).

13 Refit the circlip (photo).

14 Having repacked the joint with grease tap the boot retainer plate back on to the joint. Use a screw to line up the holes in joint and plate (photo).

#### 4 Rear wheel shafts and bearings - removal and replacement

1 Remove the NAVE plate and bearing dust cover from the wheel. Refer to Fig.7.1 and then take out the split pin from the axle shaft nut. The handbrake should be on firmly. With a socket and long bar slacken the large axle shaft nut. It is very tight. It is a safer procedure if the axle shaft nut is undone with the road-wheel still in contact with the ground before the vehicle is jacked up.

2 Jack up the vehicle, remove the axle shaft nut and pull the wheel off the shaft complete with brake drum. A puller may be needed.

3 Remove the drive shaft as described in Section 2.

4 Three screws hold the back plate assembly to the bearing housing flange. If the bearings (one roller, one ball) are to be flushed out or renewed then the handbrake cable and hydraulic brake fluid line should be disconnected and the back plate assembly taken off. Other than to add grease there is little of value to be done by merely driving the wheel shaft out without

being able to get to the bearings properly. Therefore new seals should be obtained beforehand as old ones cannot be re-used. On models made on or after August 1970 (see Fig.7.2) where the brake drum is separated from the hub, the roller bearing cannot be removed without destroying the outer race so bear this in mind also before going too far.

5 With the wheel shaft knocked out the oil seals at front and rear may be levered out. Early versions have a spacer ring running inside the outer seal which should be removed first.

6 On early models (pre August 1970) (Fig.7.1) both bearings are retained by circlips although the roller bearing and its inner race can be removed. The circlip serves to keep the outer race of this bearing in position. With the circlips removed, the ball bearing and the outer race of the roller bearing can be drifted out from the inside of the bearing housing. On the later versions there is no circlip to retain the roller bearing outer race because the race is made of sheet steel and is a press fit.

7 Between the bearings is a spacer sleeve which should be taken out of the housing. If the bearings are renewed this spacer should also be renewed. Replacements have a larger outside diameter.

8 Reassembly is a reversal of the removal procedure. The hub should be packed with 70 grams of multi-purpose grease such as Castrol LM. Work some of this well into the bearings first.

When replacing one of the later types of roller bearing it is very easy to distort the outer race if it is not driven (or pulled) squarely into the housing. Do not forget to fit the spacer between the bearings and, where necessary replace the circlip for the early type roller bearing outer race.

The later type roller bearing has a rounded edge to one side of the cage and this side goes inwards.

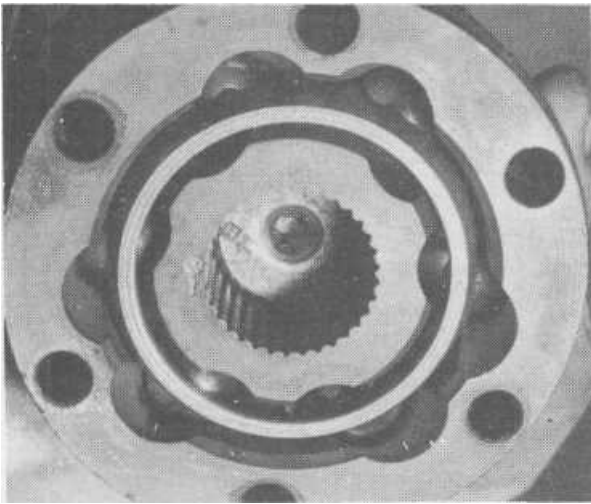
When refitting the back plate, use sealing compound between it and the bearing housing to keep water from seeping into the brakes.

On early types do not forget the spacer sleeve which fits inside the outer oil seal. The chamfered bore of the spacer faces inwards.

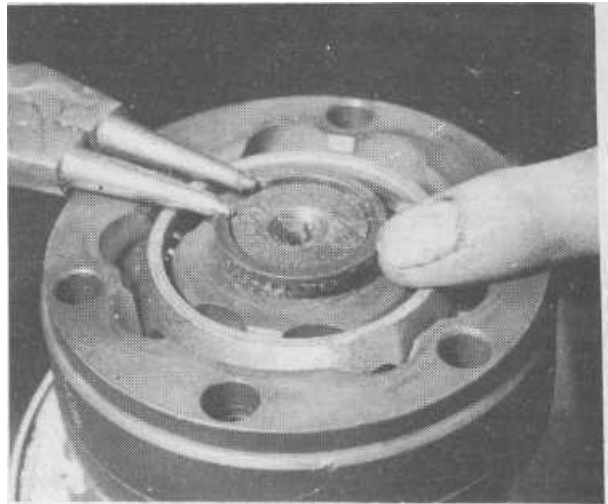
The oil seals themselves should be driven in squarely to each side of the bearing housing after the circlips have been fitted. See that the lips and open sides of the seals face inwards.

9 Reconnect the handbrake cable and the hydraulic fluid line and bleed the hydraulic system.

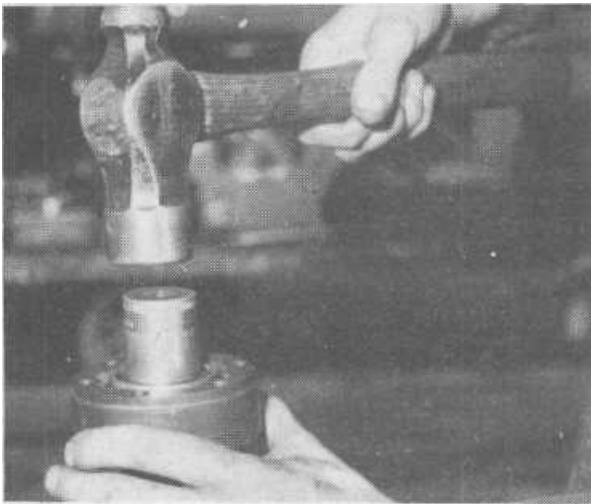
10 The axle wheel shaft unit has to be tightened to 250 lbs ft torque. This needs a proper socket and an extension on the handle. It should not be necessary to use a torque wrench because it will be simply a question of re-aligning the split pin holes with the castellations as before. The actual movement of the nut to increase the torque from, say, 150 lb ft to 250 lb ft is very little indeed. Always refit a new split pin and spread the split ends correctly.



3.12 Placing the joint on the shaft



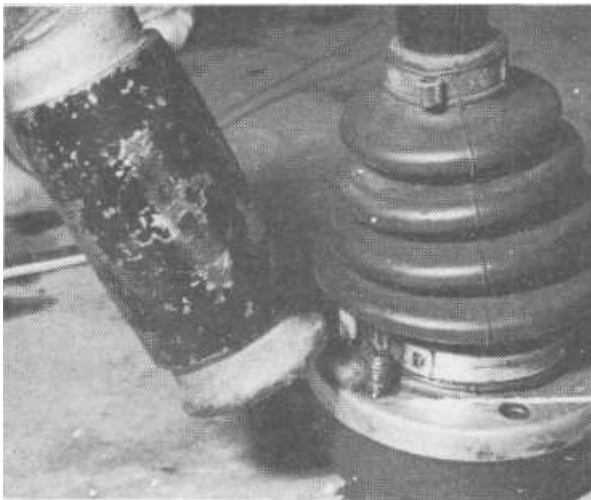
3.13a Placing the circlip over the end of the shaft



3.13b Driving the circlip home

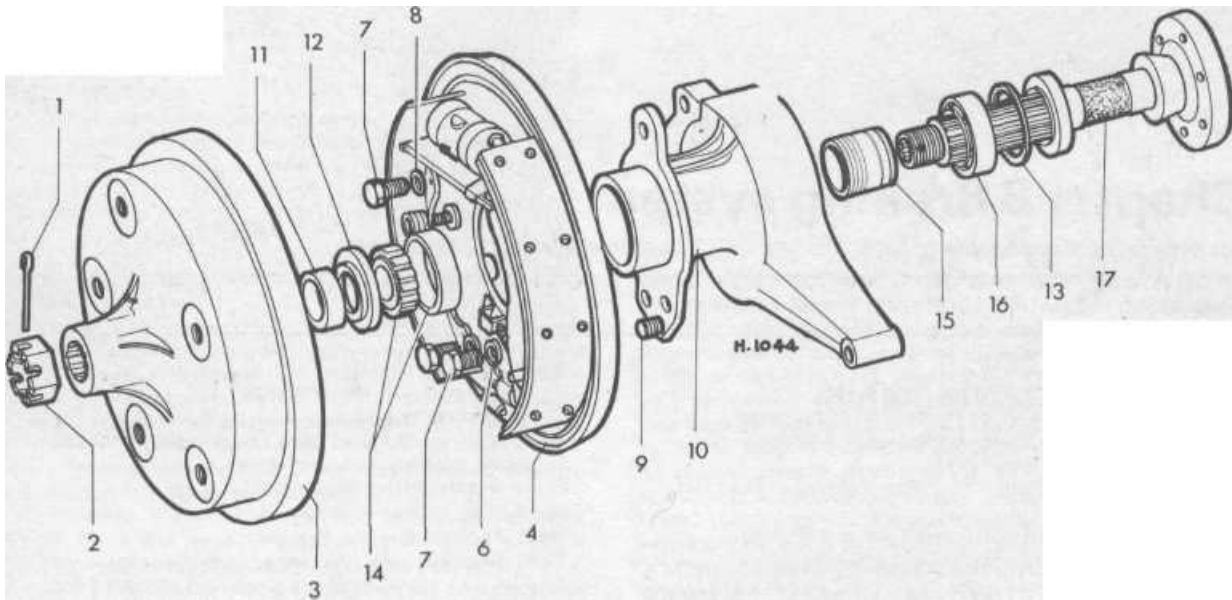


3.14a Repack the C.V joint with grease



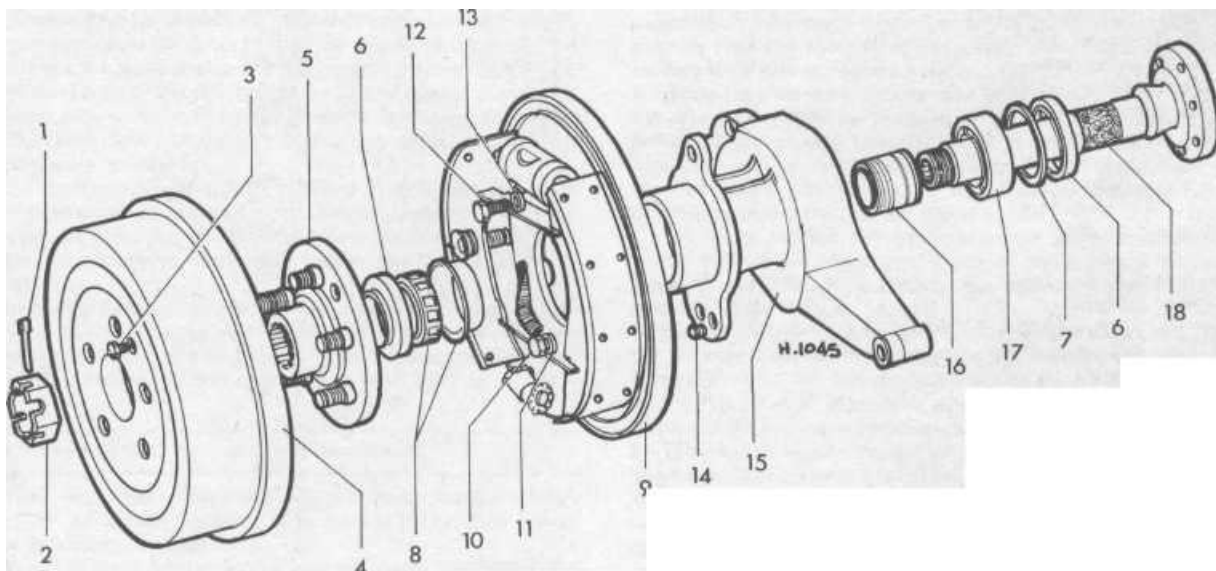
3.14b Tapping the boot retainer plate back onto the joint





**FIG.7.1 REAR WHEEL SHAFT AND BEARINGS  
(TO AUGUST 1970)**

- |                       |                 |                    |                   |
|-----------------------|-----------------|--------------------|-------------------|
| 1 Split pin           | 6 Spring washer | 10 Bearing housing | 14 Roller bearing |
| 2 Nut                 | 7 Bolt          | 11 Spacer ring     | 15 Spacer sleeve  |
| 3 Brake drum and hub  | 8 Lock washer   | 12 Grease seal     | 16 Ball bearing   |
| 4 Back plate assembly | 9 Dowel pin     | 13 Ore lip         | 17 Wheel shaft    |
| 5 Bolt                |                 |                    |                   |



**FIG.7.2 REAR WHEEL SHAFT AND BEARINGS  
(FROM AUGUST 1970)**

- |              |                      |                  |                    |
|--------------|----------------------|------------------|--------------------|
| 1 Split pin  | 6 Grease seal        | 11 Spring washer | 15 Bearing housing |
| 2 Nut        | 7 Circlip            | 12 Bolt          | 16 Spacer sleeve   |
| 3 Bolt       | 8 Roller bearing     | 13 Lock washer   | 17 Ball bearing    |
| 4 Brake drum | 9 Backplate assembly | 14 Dowel pin     | 18 Wheel shaft     |
| 5 Wheel hub  | 10 Bolt              |                  |                    |

# Chapter 8 Braking system

For information applicable to later models, see Supplement at end of manual

## Contents

General description ... ..	1	Master cylinder - overhaul ... ..	9
Brake adjustment (including the hand brake) ... ..	2	Tandem master cylinder - overhaul ... ..	.10
Front drums and brake shoes - inspection and renewal ... ..	3	Brake pressure regulator ... ..	.11
Rear drums and brake shoes - inspection and renewal ... ..	4	Hydraulic fluid lines and hoses - examination and renewal ... ..	12
Disc pads - inspection and renewal ... ..	5	Hydraulic brake system - bleeding ... ..	.13
Drum brake hydraulic wheel cylinders - renewal of seals and cylinders ... ..	6	Brake and clutch pedal assemblies ... ..	14
Disc caliper pistons and seals - inspection and renewal ... ..	7	Hand brake cables - renewal ... ..	15
Master cylinder - removal, replacement and adjustment ... ..	8	Servo mechanism ... ..	16
		Fault diagnosis ... ..	17

## Specifications

### Type

Hydraulic. Very early models single circuit, later models dual circuit system. Up to July 1970 front and rear brakes were fitted with drums and shoes. After July 1970 front brakes are disc type. In 1971 a Servo mechanism was optionally available.

Front brakes		mm	ins		
Drum diameter	...	250	9.84		
Lining width	...	55	2.17		
Lining thickness (new)	...	4.8-5.0	0.189 -0.197		
Wheel cylinder diameter	...	25.4	1.00		
Lining surface area	...	568 cm <sup>2</sup>	88 in <sup>2</sup>		
Disc diameter	...	278.2	11		
Disc thickness	...	13	0.512		
Caliper piston dia	...	54	2.13		
	new	10	0.394		
	minimum	2	0.079		
Pad surface area	...	.152 cm <sup>2</sup>	23.56 in <sup>2</sup>		
<b>Rear brakes</b>					
Drum diameter					
	To July 1970	250	9.84		
	From July 1970	252	9.92		
Lining width					
	To July 1970	45	1.77		
	From July 1970	55	2.17		
	To July 1970	4.8-5.0	0.189 -0.197		
	From July 1970	5.8-6.0	0.229 -0.236		
Wheel cylinder diameter	...	22.2			
Lining surface area					
	To July 1970	460 cm <sup>2</sup>	71.3 in <sup>2</sup>		
	From July 1970	550 cm <sup>2</sup>	100.8 in <sup>2</sup>		
<b>Tandem master cylinder</b>					
		Drum brakes		Front discs	
		mm	in	mm	in
Bore	...	22.2	0.87	20.64	0.81
Stroke (front circuit)	...	24	0.94	21	0.83
Stroke (rear circuit)	...	14	0.55	17	0.67
Clearance. Piston/pushrod	...	all 1 mm/0.04 in			
				Servo assisted	
				mm	in
				23.81	0.94
				19	0.75
				13	0.51

Deceleration, sensitive inertia ball valve type

## Chapter 8/Braking system

<b>Servo</b>		
Boosting factor	2.05	
<b>Torque wrench settings</b>		
Tandem master cylinder/support screws ...	lbs/ft 29/33	mkg 4/4.5
Front wheel cylinder and backplate on steering knuckle	40/43	5.5/6
Disc caliper on steering knuckle ...	72	10
Rear axle shaft (for brake drum) ...	253	35
Rear back plate bolts . . . . .	25	3.5

### 1 General description

Prior to August 1970, hydraulically operated drum brakes were fitted to all four wheels. The front brakes had two wheel cylinders and leading shoes for each drum. The rear brakes had a single wheel cylinder operating one leading and one trailing shoe. After August 1970 disc brakes were fitted to the front wheels. At the same time the rear brake shoes were increased in width and the drum was made detachable from the hub.

All shoes for drum brakes may be individually adjusted nearer to the drums by a threaded adjuster tappet which is moved by a notched wheel. Disc brakes are self adjusting.

A master hydraulic cylinder is operated by the foot pedal and generates the pressures which passes to the four wheel cylinders. The pipe lines are rigid metal except where they link from body to moving assemblies. The master cylinder is the tandem type which maintains the hydraulic pressure to either the front or rear wheels should the other fail.

The handbrake operates on the rear wheels only and the leverage from the handle is transmitted by two cables running in tubes inside the floor frame tube.

Hydraulic fluid level is maintained in the master cylinder by a reservoir situated on the bulkhead below the dash panel in the driving compartment. The braking system operates when pressure on the foot pedal moves a piston in the master cylinder (in effect a pump). This pressurizes the hydraulic fluid in the pipe lines and forces the pistons outwards in the wheel cylinders. These in turn press the shoes against the drums. When pressure is relieved the shoes are drawn off the drums by retractor springs. The friction pads of the disc brakes are forced against the disc by hydraulic pistons also. When the pressure is relieved the piston seals flex sufficiently to permit the piston to retract fractionally. No springs are necessary.

The master cylinder piston is fitted with a spring loaded check valve which maintains a slight residual pressure in the fluid lines but not enough to actually move pads or shoes. This ensures instantaneous movement when the brake pedal is applied.

On models fitted with disc brakes a hydraulic pressure regulating valve is fitted in the rear circuit which alters the braking pressure to the rear wheels depending on decelerating and load conditions. Servo is available as an option from 1971 on.

### 2 Brake adjustment - (including the handbrake)

1 Brake adjustment is carried out with each wheel in turn jacked up sufficiently to allow it to revolve freely. Disc brakes adjust themselves automatically.

2 To adjust the front shoes remove the wheel nave plate and turn the wheel until the hole in the drum is at the top. The teeth of the notched adjusting wheel on the top cylinder will then be visible. Turn the notched wheel in the direction as shown in Fig.8.1 depending on which front wheel is being adjusted. The adjuster should be moved in the appropriate direction with a screwdriver engaged in the notch until it can be moved no further and the wheel is locked. Then back off the adjuster one or two notches until the wheel revolves freely.

Repeat the adjustment on the other shoe by turning the drum so that the hole is opposite at the bottom. On later models the hole in the drum was discontinued and holes were put in the

back plate instead, covered with detachable rubber plugs. The adjustment mechanism is the same. The rotation of the adjuster wheels for the front drums, will be opposite to that shown in the diagram; also the position of the cylinders will be the other side of the vertical centre line when viewed from the back plate side.

If any shoe(s) needs considerable adjustment (because they have been allowed to go unadjusted too long) then they will have to 'bed in' again to a different radius and this will call for further adjustment after a short interval. This is why regular brake adjustment is necessary to ensure top braking efficiency at all times. The linings will also last longer as it will ensure that the whole surface area is used evenly all the time.

3 The rear brake adjustment is similar except that both adjuster wheels are at the bottom (see Fig.8.1). On the earlier models access to the adjusters is through a hole in the drum, but later versions with detachable drums have the access holes behind through the back plate. The holes have detachable rubber sealing plugs.

When adjusting the rear brakes remember that when turning the wheels the drag of the transmission will be felt. Do not confuse this with binding brake shoes.

4 Having completed adjusting one wheel it is good practice to operate the brake pedal once or twice and then adjust again. Sometimes the shoes can move fractionally off-centre during adjustment. The extra time required is well worth the trouble.

5 If a shoe still rubs against the drum a little even after being backed off more than 3 notches, leave it (provided it is only superficial). However, if the binding is quite severe then it is possible that the lining is very unevenly worn. In such instances remove the drum and have a look.

6 Once the rear brake shoes have been adjusted to the drums the handbrake may be checked. If both back wheels can be jacked off the ground together it will save some time. Pump the footbrake two or three times (to centralise the shoes) and apply the handbrake six notches. In this position it should be just possible to rotate the rear wheels by hand.

7 On early models the cable adjusters are located under a rubber shroud just ahead of the base of the gear lever in the cab floor (photo). On later models, the adjusting nuts are at the equaliser under the car.

8 Slacken the locknut on the threaded end of each cable. Then tighten each cable with the adjusting nut (holding the cable with a screwdriver in the slotted end) until an equal amount of drag can be felt on each rear wheel when it is turned. Make sure any adjustment is kept even between the two rear wheels.

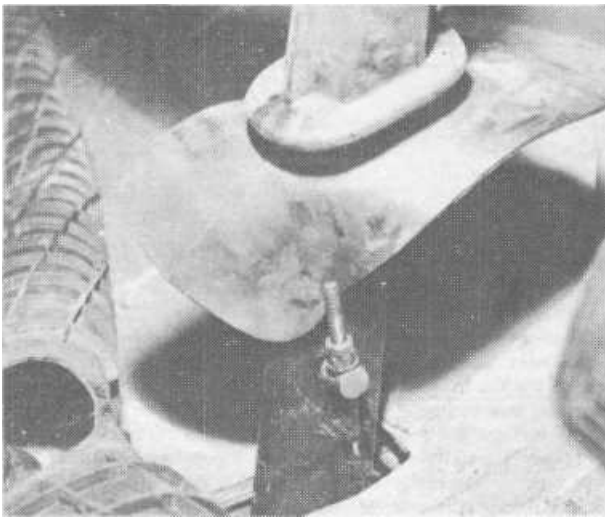
9 The brakes should hold the wheels when a further 2 - 3 notches are pulled on the handbrake.

10 Understand that the handbrake cable adjustment is purely to compensate for stretch in the cable. It must not be made until after the shoes have been correctly adjusted to the drums.

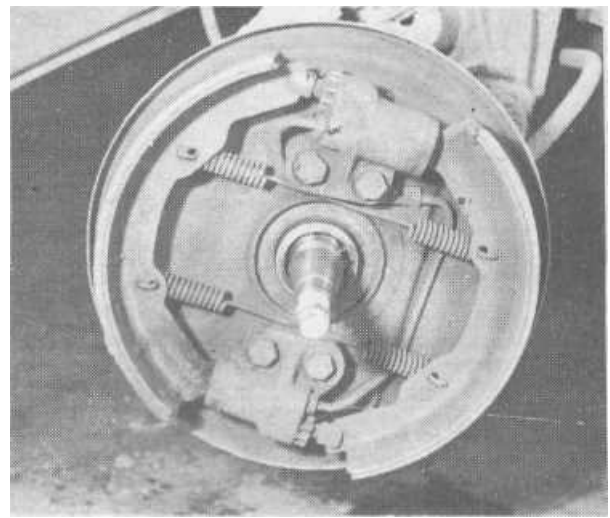
### 3 Front drums and brake shoes - inspection and renewal

1 The front brake drums form part of the wheel hub casting so they have to be taken off the stub axle. This involves releasing the front wheel bearings, details of which are given in Chapter 10. Before pulling the drum off, back off the shoe adjusters as far as they will go.

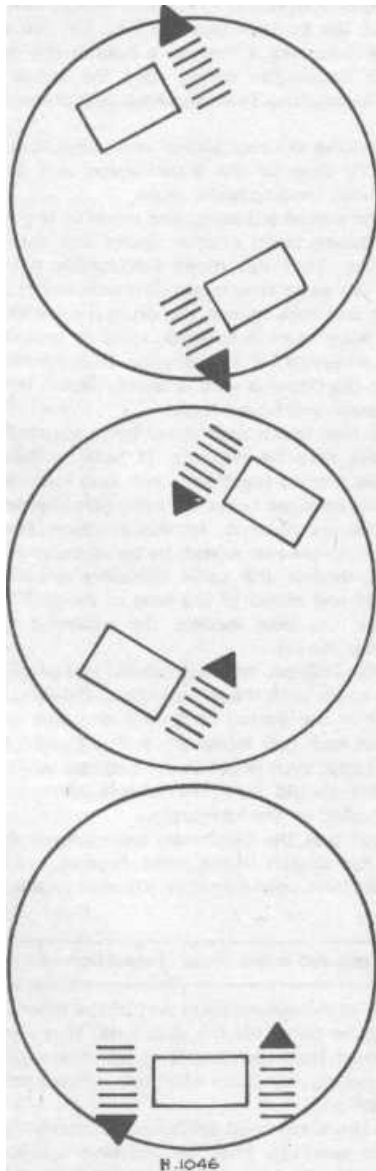
2 With the drum removed (photo) first check that both wheel cylinders are working. With an assistant operating the brake pedal, jam each shoe in turn with a screwdriver against the back



2.7 The handbrake adjuster #8 under the rubber grommet (early models)

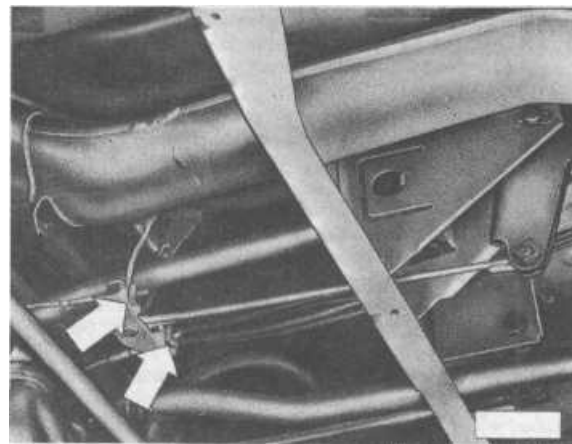


3.2 Front drum brake

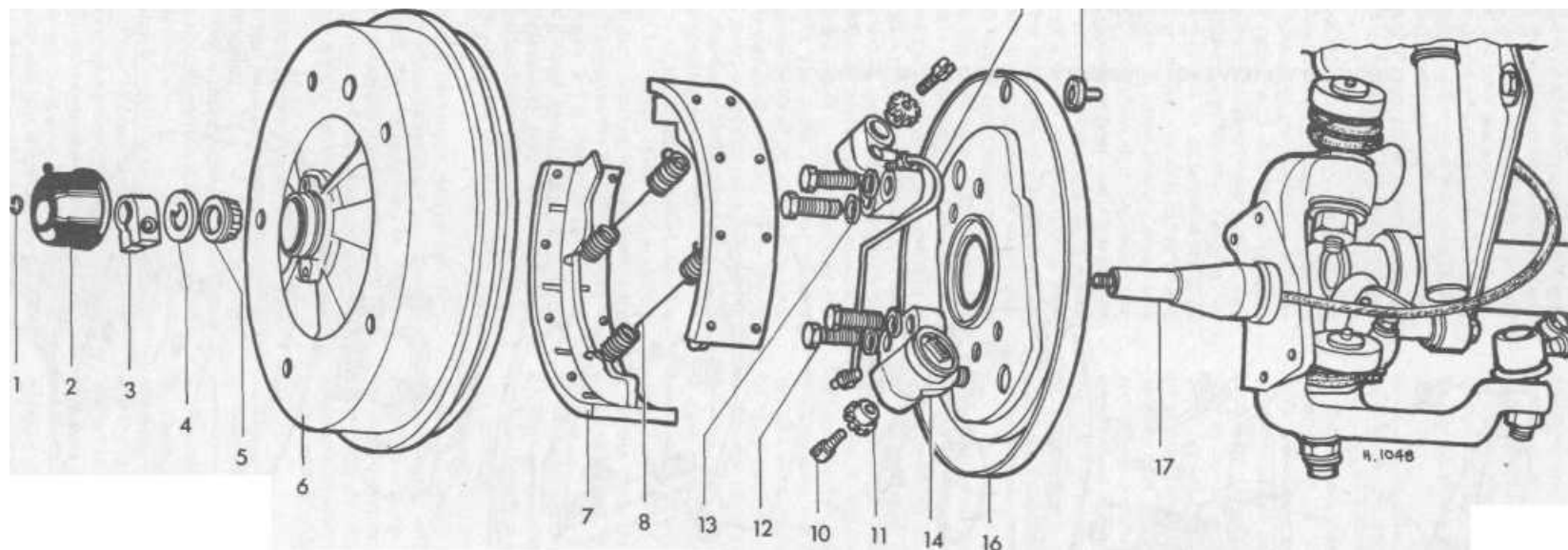


**FIG. 8.1 BRAKE ADJUSTMENT - MOVEMENT OF ADJUSTER WHEELS TO PUT SHOES NEARER THE DRUMS (Sec. 2)**

- A Front drum LEFT viewed from drum side
- B Front drum RIGHT viewed from drum side
- C Rear drums viewed from either side



**FIG 8.2 HANDBRAKE CABLE ADJUSTERS ON LATER MODELS (Sec. 2)**



**FIG. 8.3 FRONT WHEEL DRUM BRAKE ASSEMBLY (SEC. 3)**

1 C washer (for speedo cable only)  
2 Dust cover

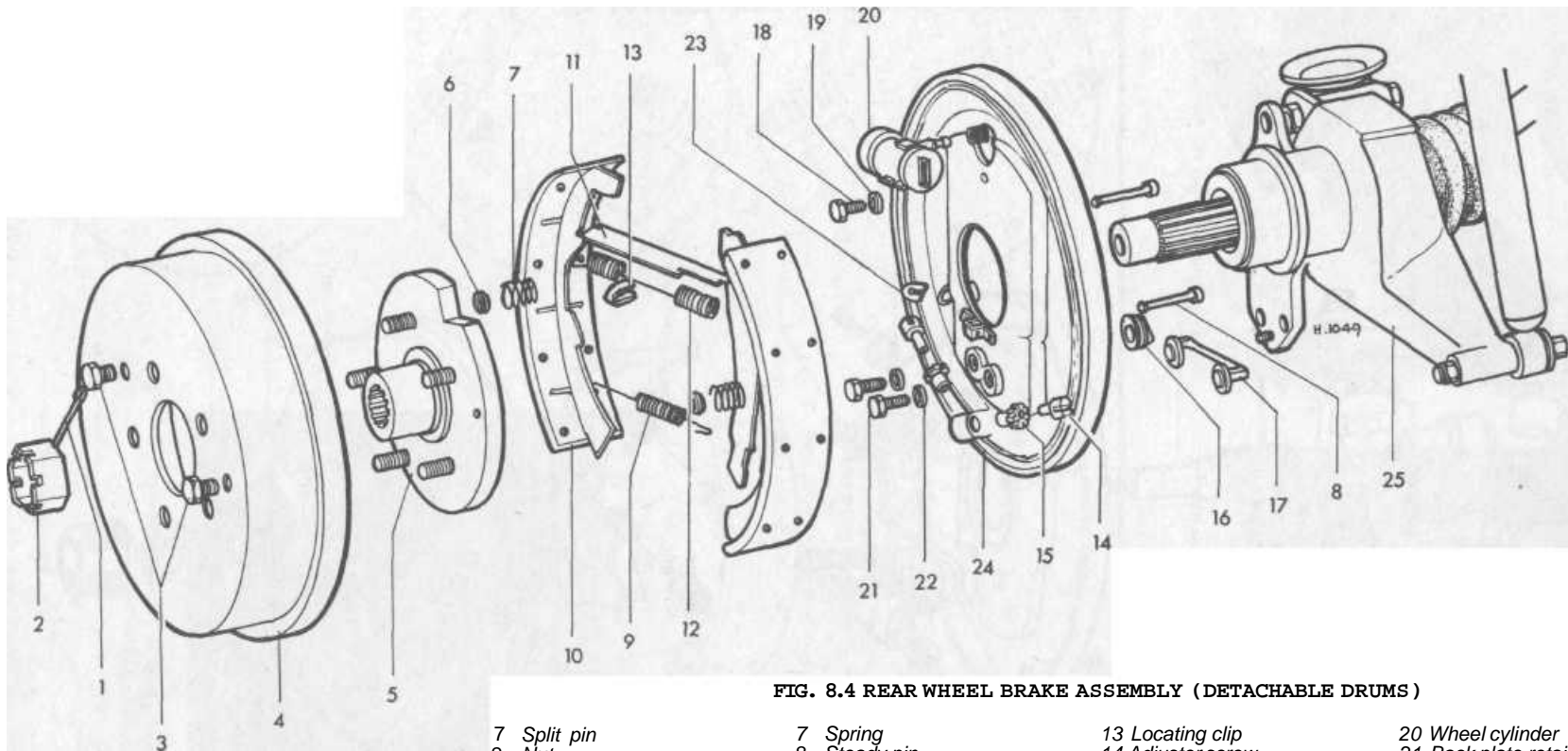
3 Bearing clamp nut  
4 Thrust washer  
5 Wheel bearing

6 Brake drum  
7 Brake shoe  
8 Return spring

9 Connecting line  
10 Adjusting screw  
11 Adjusting wheel

12 Bolt  
13 Lock washer  
14 Brake cylinder

15 Plug  
16 Back plate  
17 Steering knuckle



**FIG. 8.4 REAR WHEEL BRAKE ASSEMBLY (DETACHABLE DRUMS)**

- |                      |                   |                        |                              |
|----------------------|-------------------|------------------------|------------------------------|
| 7 Split pin          | 7 Spring          | 13 Locating clip       | 20 Wheel cylinder            |
| 2 Nut                | 8 Steady pin      | 14 Adjuster screw      | 21 Back plate retaining bolt |
| 3 Socket head screw  | 9 Return spring   | 15 Knurled adjuster    | 22 Spring washer             |
| 4 Brake drum         | 10 Brake shoe     | 16 Plug                | 23 Hose circlip              |
| 5 Wheel hub          | 11 Distance piece | 17 Retaining pin       | 24 Backplate                 |
| 6 Slotted cup washer | 12 Return spring  | 18 Wheel cylinder bolt | 25 Suspension arm            |
|                      |                   | 19 Spring washer       |                              |



plate and see that the other shoe is moved by the hydraulic piston when the brake pedal is depressed. Do not let the piston come right out or the system will need bleeding after reassembling it. If either piston will not move it must be seized. This will require overhaul or renewal as described in Section 6. If steady clips are fitted prise them out of the back plate.

3 To remove the shoes pull one end of a shoe back against the spring until it can be moved out of the slot in either the adjuster or piston. Once two ends have been released in this way they can all be easily removed. If either of the pistons show signs of coming out of the cylinder tie it up with a piece of string to keep it in.

4 The shoe lining surface should be not less than 0.5 mm (0.020 inch) above the rivet heads. Anything less and new linings should be fitted. If the linings have been contaminated with oil they will not work efficiently again and should be renewed. Great care should be exercised when handling brake shoes as oily or greasy hands can contaminate them significantly. The material is extremely absorbent. It is important to isolate the cause of contamination. If not the wheel cylinder, the only other source can be from grease flung out from the wheel bearing. Make sure the bearing grease seal is intact and renew it if necessary (see Chapter 11, which deals with front wheel bearings). Volkswagen supply linings and rivets to fit the original shoes. If you should contemplate renewing the linings yourself it is essential to have the proper punch tools for fixing the rivets. If you do not have these the simplest thing is to ask the supplier to fix them. Provided you have cut off the old linings and rivets it takes about two minutes per lining to fix the new ones, if you have the correct tools. One of the punches is clamped in the vice and the new lining, shoe and rivet head held over it whilst the end is belled over with the other special punch. Riveting should start from the centre and work outwards diagonally. Alternatively, other sources of supply may provide exchange shoes complete with linings fitted. Whatever you do it is important that the linings are all of the same make and type. It is best to fit a complete new set and make a proper job of it, or you will have uneven braking and trouble on wet road surfaces. Never try to renew the lining on one wheel only, always in pairs, and best in complete sets. Note also that the front brake shoes are wider than the rear ones and are not interchangeable.

5 Examine the friction surfaces of the brake drums. If they are in good condition they should be bright, shiny and perfectly smooth. If they show signs of deep scoring (due to over-worn brake linings) then they will need renewal. It may be possible to have them machined out on a lathe but if this is done it will be essential to fit oversize brake linings accordingly. This work should be carried out by a Volkswagen agent or an acknowledged brake specialist. It is a waste of time fitting new linings to work in scored drums (except when the scoring is only very light).

6 Before replacing the shoes the backplate should be thoroughly brushed off and the two adjusters removed and cleaned so that they can be freely turned. The threads may be treated with a very light touch of high melting point grease. Replace the adjusters; if the bottom one tends to fall out leave it until the shoes are refitted. Both adjuster should be screwed right in to the notched wheels.

7 Examine the hydraulic cylinder. The rubber boots should be intact and there should be no sign of fluid leakage. If there is then the cylinders must be overhauled.

8 Before starting to refit the shoes make sure you have them the right way round. The ends are different and the narrow end of the web fits into the adjuster.

9 Hook the two retractor springs in from the back of each shoe and whilst holding the two shoes and springs fit the ends of the rear shoe into the slots in adjuster and piston. Then use a screwdriver to lever the other shoe into the other slots.

There is a hydraulic fluid connecting pipe between the two cylinders on the back plate. Make sure this is not damaged when levering the shoes into position. After the shoes are in position make sure that the retractor springs are not touching the pipe. If they do they may wear a hole in it. Refit the steady clips.

10 Centralise the shoes (otherwise you may have difficulty replacing the drum) and then refit the drum and wheel bearing, adjusting the bearings as described in Chapter 10. If the wheel cylinders have been overhauled bleed the hydraulic system (Section 13).

11 Adjust the shoes to the drums as described in the previous section. If new linings have been fitted further adjustment may be needed after a few hundred miles.

#### 4 Rear drums and shoes - inspection and renewal

1 Rear brake shoes tend to wear most on the front shoe at the adjuster end. If, however, brake adjustment has been neglected they will wear more at the cylinder ends of the shoes. In such cases the visual check of the brake lining material through the inspection hole (later models only) could be misleading. There may be less material thickness at the other end of the shoe.

2 If the vehicle is pre August 1970 the rear drum and hub will be in one piece. To get these off the shaft nut must be undone as described in Chapter 7. On later models the drum can be removed separately. Take off the wheel and remove the two socket head cap screws holding the drum to the hub. Back off the brake shoe adjusters and remove the drum.

3 Before going any further check that both pistons in the hydraulic cylinder are working by using the method described in the previous section.

In the centre of each shoe a retaining pin, held in position by a spring loaded, slotted cup washer, must first be removed. This can be done with a pair of pliers, turning the washer so that the slot aligns with the head of the pin. Washer, spring and pin can then be removed. Some models may have clips fitted instead of the pins. These should be prised out of the backplate.

4 Unhook the lower of the two retractor springs and then unhook the handbrake cable from the operating lever.

5 Disengage the ends of the two shoes from the adjusters and the two shoes together with the handbrake lever and plate may be lifted out.

6 Linings should be renewed if the surface is worn to within 0.4 mm (0.02 inch) or less of the rivet heads at any point. Also, if there is any indication of oil contamination the linings must be renewed. Details for relining may be found in the section dealing with front brakes.

7 If the shoes are to be changed remember to remove the handbrake operating lever by pulling off the clip which fixes it to the shoe.

8 When reassembling the two shoes prior to refitting, the connecting rod should engage in the two slots and the shoe with the lever attached goes to the rear with the lever notch facing the rear (photos).

9 Make sure that the adjuster wheels are free-moving and fully backed off before locating the ends of the shoes in the slots. On vehicles made after August 1970 the brake shoes have angled ends. The adjuster slots are angled to suit them and it is important that the adjusting screws are fitted the right way up.

10 If there are signs of oil leaks from the hydraulic cylinder, or grease contamination from the bearings the renewal of seals must be carried out. Otherwise any repair work on the shoes is wasted.

#### 5 Disc pads - inspection and renewal

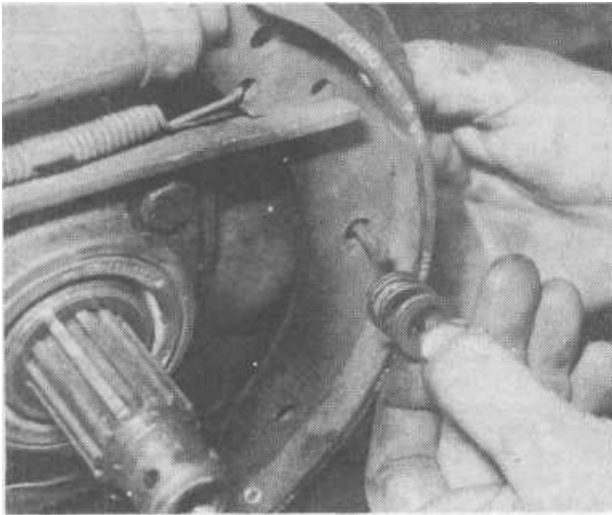
1 Remove the front wheel.

2 There are two visual examinations to be made before dismantling anything. These are the thickness of the friction pad and the gap between the pad and disc.

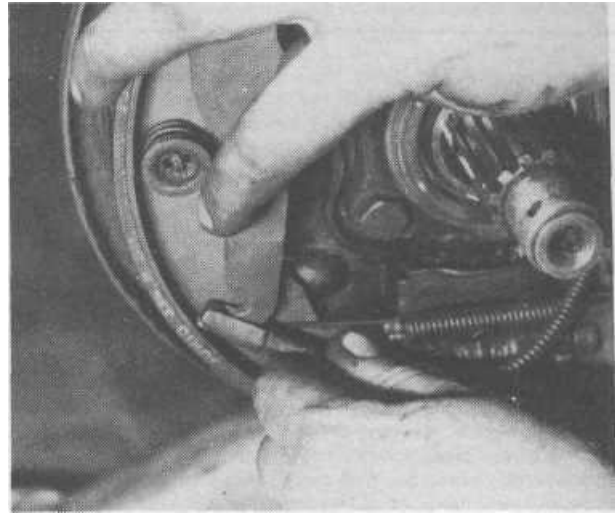
3 Pad friction material thickness must not be less than 2 mm otherwise the pads should be renewed.

4 The residual clearance should not be more than 0.2 mm (0.008 inch) between disc and pad. This can be measured with a feeler gauge.

5 If the gap is greater it is probably due to a sticking piston. A simple remedy is given later on in this section.



4.8a Fitting the steady pin, spring and washer whilst assembling the right rear brake shoe assembly



4.8b Hooking the handbrake cable to the lever on a right rear brake assembly

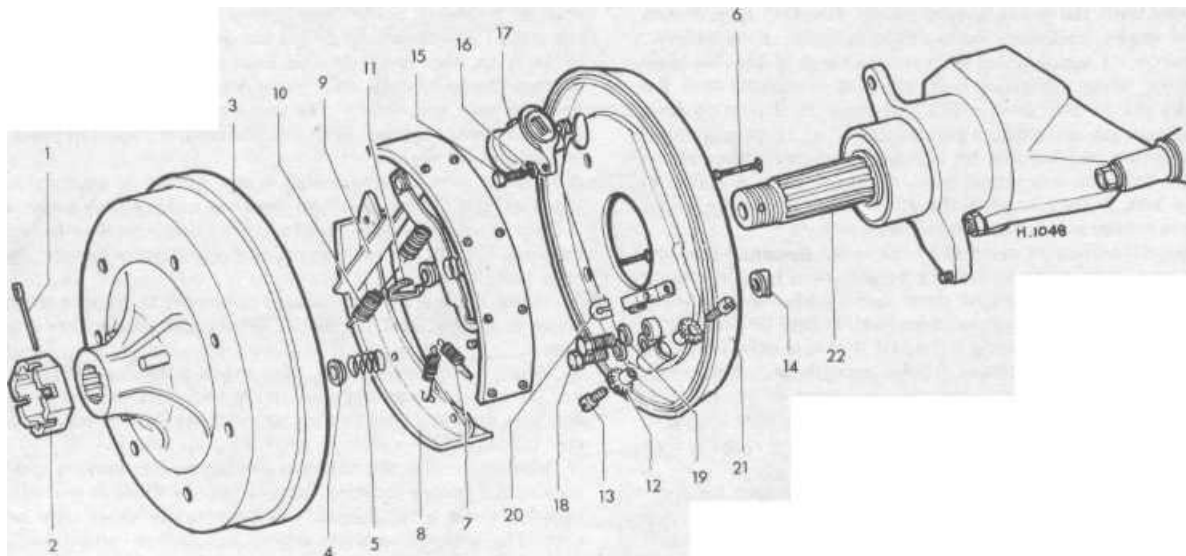


FIG. 8.5 REAR WHEEL BRAKE ASSEMBLY (ONE PIECE HUB AND BRAKE DRUM) (SEC. 4)

- |                      |                   |                    |                         |
|----------------------|-------------------|--------------------|-------------------------|
| 1 Split pin          | 6 Steady pin      | 11 Clip            | 17 Wheel brake cylinder |
| 2 Nut                | 7 Return springs  | 12 Adjusting nut   | 18 Bolt                 |
| 3 Brake drum and hub | 8 Brake shoe      | 13 Adjusting wheel | 19 Lock washer          |
| 4 Slotted cup washer | 9 Connecting link | 14 Plug            | 20 Brake cable          |
| 5 Spring             | 10 Return spring  | 15 Bolt            | 21 Back plate           |
|                      |                   | 16 Lock washer     | 22 Wheel shaft          |

6 If the pads are to be used again mark where they came from beforehand so they may be put back in the same position. Drive out the retaining pins from the outside with a long nosed punch. Lift off the spring plate.

7 Before removing the old pads it is best to force them away from the disc carefully, with a suitable flat metal lever. This will push the pistons back. Before doing this it will be necessary to remove some hydraulic fluid from the reservoir to prevent it overflowing when the pistons are pushed back. Do this with a suitable suction device such as an empty flexible plastic bottle.

8 Once the pistons are pushed back remove the pads. Do not disturb the piston retaining plate. If it does come out note the reassembly details in Section 7.

9 Blow out the aperture in the caliper and examine the seal which should show no signs of cracking or brittleness. If it does it should be renewed (see Section 7).

10 Fit the new pads. New pad retaining spring plates are normally provided with the pads and these should be used. When replacing the retaining pins (from the inside) do not use a punch smaller in diameter than the pin. Preferably, use no punch at all otherwise there is a possibility of shearing the shoulder off against the split clamping bush.

11 Pump the brake pedal to bring the pads up to the disc and check the level of hydraulic fluid in the reservoir.

12 If the clearance between the disc and pad is too great after brake operation then this is an indication that the inner piston rubber seal is sticking somewhat and distorting more than normally. This retracts the piston more than usual when the pressure is taken off. Movement of the piston can usually cure this. Remove a brake pad and put in a block of wood no less than 6 mm thick. Pump the brakes to force the piston further out and then force it back again. Do this a few times and the problem should disappear. If not it will be necessary to check the piston seals and caliper cylinders thoroughly as described in Section 7.

#### 6 Drum brake hydraulic wheel cylinders - renewal of seals and cylinders

1 If the wheel cylinders show signs of leakage, or of pistons being seized up, then it will be necessary to dismantle them and fit new seals. The cylinders in the front brakes have one piston and seal each. To renew the seals it is not necessary to remove the cylinder but the wheel, brake drum and brake shoes must all be taken off as described in Section 3. Seal the cap of the hydraulic fluid reservoir with a piece of plastic film to minimise fluid loss from the system.

2 Pull the rubber boot off the end of the cylinder and pull the piston out from the cylinder. If the piston is stuck tie up the opposite cylinder to prevent the piston coming out and depress the brake pedal to force the piston out. In extreme cases of seizure the cylinder must be renewed completely.

4 With the cylinder clear examine the bore surfaces for signs of ridging or scoring. Any residue stuck in the bore should be cleaned out with brake fluid or meths - if very stubborn a gentle rub with some No. 400 wet and dry paper will clean it up. Any noticeable scores or ridges indicate that a new cylinder should be fitted. No attempt should be made to smooth them out as this will be unsuccessful.

5 To remove the cylinder undo the brake pipe union from behind the backplate. Cover the end of the pipe with the dust cap from the bleed nipple pro tern. Then undo the union of the connecting pipe.

5 Undo the two securing screws from the backplate and the cylinder may be lifted out. If a new cylinder is fitted the diameter of the bore must be exactly the same as the diameter of the one being replaced, otherwise the balance of the brakes will be upset.

6 With the cylinder and piston perfectly clean fit a new seal on to the piston with the lip facing into the cylinder. Then lubricate the cylinder bore with hydraulic fluid and carefully insert the piston, making sure that the lip of the seal does not get turned

back.

7 Rear brake cylinders are somewhat different in that each contains two pistons. However the procedure for fitting new seals to the pistons is the same. Both lips should face inwards. Also, provided one piston comes out the other can be driven out if necessary using a piece of wooden dowel.

If new wheel cylinders are being fitted, front or rear take care in reconnecting the brake pipes. It is easy to cross the union threads or overtighten the union. Make sure that flexible hoses are not twisted or kinked during the course of tightening up.

#### 7 Disc caliper pistons and seals - inspection and renewal

1 Before assuming that anything is wrong which requires removal of the caliper pistons make sure that the checks in connection with renewal of the friction pads as described in Section 5 have been carried out.

2 Discs may deteriorate, if left unused, due to corrosion. If this happens it is best to let a VW agency repolish them with special blocks which can be inserted in place of the friction pads. Discs which are badly scored or distorted must be renewed. It is possible to have them re-machined but the economics of this against fitting new parts should be examined.

The run-out of the disc can be checked only with a clock gauge micrometer. With the bearing properly adjusted the run-out should not exceed 0.2 mm (0.008 inch).

3 To renew a disc or repair piston seals, the caliper assembly must first be removed. It is held by two bolts from the back of the steering knuckle. (If the disc only is to be removed it is not necessary to disconnect the hydraulic fluid hose. The whole assembly should be tied up onto the bodywork to prevent any strain on the hose). If the pistons are to be removed from the caliper thought must first be given as to how pressure can be applied to force them out. Only one piston can be worked on at a time as the other piston must be installed and clamped in position so as to maintain pressure to force the other out. Pressure can be applied from a foot pump if you rig up a spare hydraulic pipe union and short length of pipe to which the pump connector will fit. One piston will have to be clamped in such a way that there will still be room enough for the other to come right out. Here again a tong-like clamp may have to be made up from some T/4 x 1/8 inch flat steel bar if you are unable to obtain a suitable tool.

4 Mount the caliper assembly in the vice padding the jaws suitably so that the flange of the caliper will not be scored or marked. The friction pads and retaining plates should be removed (see Section 5).

5 Prise out the outer seal using a blunt plastic or wooden tool. Do not use sharp tools for fear of scoring the piston or cylinder.

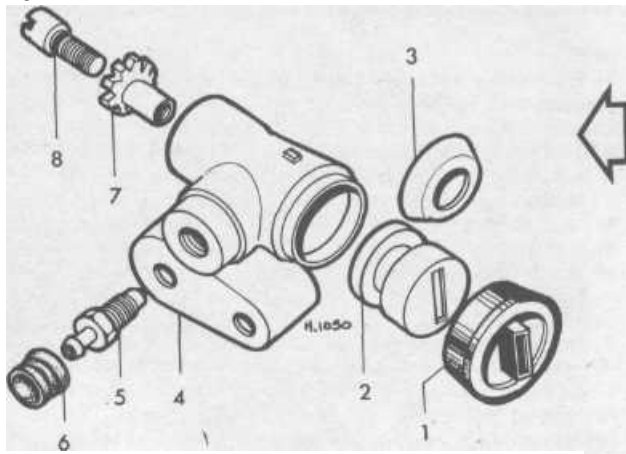
6 Using a clamp to hold one piston force the other out under pressure as described in paragraph 3. To prevent damage in case the piston should come out with force put some cloth in the caliper to prevent it striking the piston and clamp opposite.

7 With the piston out the rubber sealing ring can be taken out of its groove in the cylinder; once again use only a blunt article to get it out.

8 With methylated spirits or hydraulic fluid, clean the piston and cylinder thoroughly. If there are any signs of severe scoring or pitting then renewal will be necessary. With the cylinder this involves renewing the whole caliper unit.

9 When renewing seals the piston retaining plate must also be renewed. The VW service kit includes all the items needed. Use them. Before reassembly it is advantageous to coat the piston and new rubber seal with VW cylinder paste specially formulated for this job. Otherwise make sure they are thoroughly lubricated with clean hydraulic fluid. On no account use anything else.

10 Fit the rubber seal in the cylinder groove and then fit the piston into the seal. Great care must be taken to avoid misaligning the seal when doing this and the piston must be kept square while it is pushed in. The cut-out portion of the piston should lie facing in to the centre of the disc and against the direction of forward disc rotation.

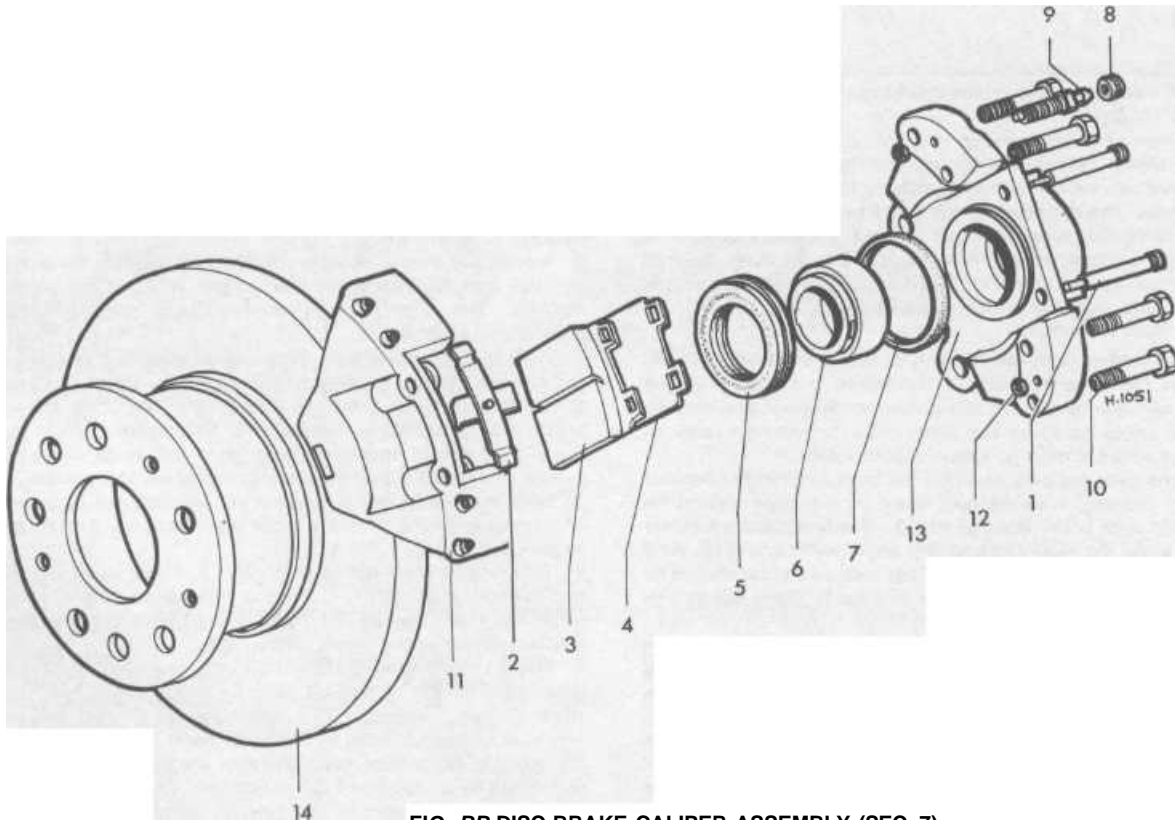
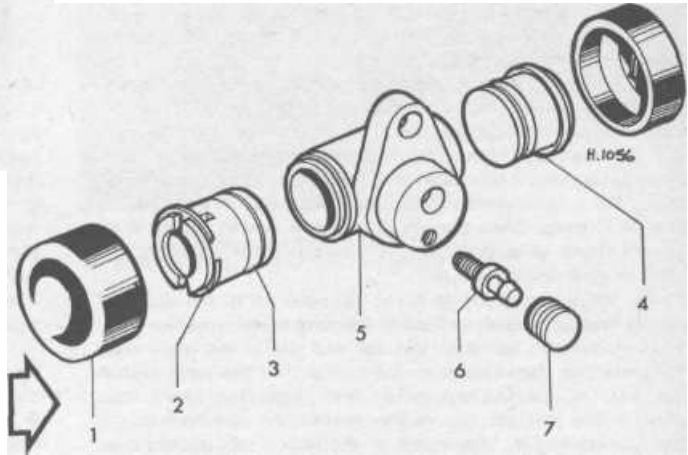


**FIG. 8.6 FRONT WHEEL HYDRAULIC BRAKE CYLINDER (SEC. 6)**

- |           |                   |
|-----------|-------------------|
| 1 Boot    | 5 Bleed valve     |
| 2 Piston  | 6 Dust cap        |
| 3 Cup     | 7 Adjusting nut   |
| 4 Housing | 8 Adjusting screw |

**FIG. 8.7 REAR WHEEL HYDRAULIC BRAKE CYLINDER (SEC. 6)**

- |           |               |
|-----------|---------------|
| 1 Boot    | 5 Housing     |
| 2 Piston  | 6 Bleed valve |
| 3 Seal    | 7 Dust cap    |
| 4 Circlip |               |



**FIG. BB DISC BRAKE CALIPER ASSEMBLY (SEC. 7)**

- |                          |              |                       |                       |
|--------------------------|--------------|-----------------------|-----------------------|
| 1 Pad retaining pin      | 5 Dust seal  | 9 Bleed valve         | 13 Caliper inner half |
| 2 Spreader spring        | 6 Piston     | 10 Screw              | 14 Brake disc         |
| 3 Friction pad           | 7 Fluid seal | 11 Caliper outer half |                       |
| 4 Piston retaining plate | 8 Dust cap   | 12 Sealing ring       |                       |

- 11 Fit the new outer seal.
- 12 Repeat the process for the other piston.
- 13 Refit the caliper to the knuckle, tightening the securing bolts to 72 lb ft/10 mkg. Replace the piston retainer plates noting that they should lie flush against the piston and have the two stamped lugs in the plate engaging the recess in the piston. If the plates cannot be made to fit flush then the piston should be rotated until they do.
- 14 The disc itself may be removed after the caliper is taken off.
- 15 Remove the hub cap - (on the left wheel, this involves removing the 'C' washer securing the speedo cable). Undo the bearing nut clamp screw, remove the nut and pull off the disc which is an integral part of the wheel hub.
- 16 Replace the disc in the reverse order and re-adjust the wheel bearing as detailed in Chapter 10.
- 17 Refit the caliper to the knuckle and tighten the two retaining bolts to the correct torque of 72 lb ft/10 mkg.
- 18 Do not split the two halves of the caliper. If the joint shows signs of leakage, renew the caliper complete.
- 19 When the caliper is replaced reconnect the hydraulic fluid hose and bleed the system as described in Section 13.

### 8 Master cylinder - removal, replacement and adjustment

1 Some of the earliest models were fitted with single circuit brake master cylinders. These were soon superseded by the dual circuit system for which a tandem master cylinder is fitted.

The tandem master cylinder comprises a single cylinder in which there are two pistons one behind the other. Each circuit is supplied independently with fluid. If the pressure in one circuit should fail the other is not affected. Provided the slave cylinders and fluid lines are all in good condition and there is no air in the system then any softness or sponginess in the system will probably be due to worn seals in the master cylinder. As these are internal there will be no visible leak to indicate this.

- 2 To remove the cylinder first take off the undertray covering the steering mechanism at the front underneath.
- 3 There is a plastic fluid reservoir mounted on the cylinder. Get a suitable container handy and press the reservoir up and out of the rear sealing plug. Catch the fluid as it drains out. Then push out the front end of the reservoir.
- 4 Disconnect the piston rod at the clevis pin, and undo the outlet pipe connections. Prior to August '69 there were two outlet pipes to the front brake circuit; after that there was only one, running to a T piece (photo).
- 5 Undo the screws securing the cylinder to its support and take it out.
- 6 Replacement is a reversal of the removal procedure. Replenish the reservoir with clean fluid (photo) and bleed the brake system at all four wheels. With disc brake models at least 1 pint of fluid will be required.
- 7 It is important that the pushrod which operates the plunger from the brake pedal is correctly set. In the rest position, the ball end of the pushrod should have a 1 mm clearance before it contacts the bottom of the recess in the piston. If this clearance is absent (and the piston cannot return fully) the operation of the system is seriously affected. On models up to Chassis No. 219238131 the adjustment is made on the brake pedal stop. The piston rod on these models is set at a length of 106 mm. from the end to the centre of the eye of the clevis and this must not be altered. The 1 mm clearance on the cylinder represents 4—6 mm movement at the top of the brake pedal. An adjustable back stop at the bottom of the pedal arm can be altered as required. From Chassis No. 2102000001 on the adjustment may be made on the piston rod itself. Undo the lock nut near the clevis and rotate the rod until the pedal movement is as required.

### 9 Master cylinder (single circuit) - overhaul

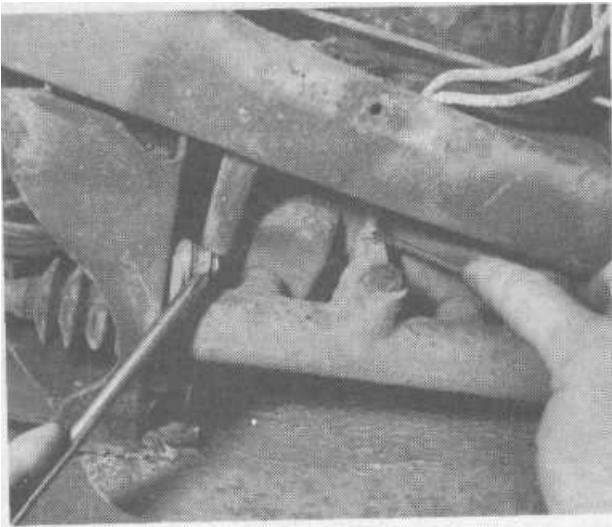
- 1 Obtain a complete repair kit which contains all the necessary

seals which must all be used.

- 2 Thoroughly clean the exterior before beginning dismantling.
- 3 Unclip the circlip from inside the cylinder bore and remove the various parts in order. Pull out the reservoir pipe sealing plug.
- 4 Examine the inside of the cylinder bore for any sign of scoring or pitting. Unless it is perfectly smooth the body should be renewed.
- 5 Thoroughly clean all parts. Pull off the seal from the groove in the piston.
- 6 Before reassembly lubricate all parts with clean brake fluid.
- 7 Assemble the wide end of the spring to the boss on the residual pressure valve and place both in position in the cylinder.
- 8 Place the new primary cup seal into the cylinder, concave side inwards and take great care to ensure that the lips of the seal edges do not turn back in the process. Put the piston washer in immediately behind it.
- 9 Take the piston and fit the new secondary seal into the groove at the rear end. This seal must be fitted so that the tapered lip faces into the cylinder when the piston is replaced. Make sure it is squarely seated in position.
- 10 Put the piston into the cylinder (the recessed end faces outwards) and when the seal goes in once again make quite sure that the lip does not turn back.
- 11 Fit the stop plate followed by the circlip which must snap securely into the annular groove in the cylinder.
- 12 Make sure that the rubber plug washer and elbow are intact and ready for connection to the reservoir feed pipe on installation. The rubber boot is fitted over the cylinder (or pushrod) before the cylinder is replaced.

### 10 Tandem master cylinder -overhaul

- 1 Thoroughly clean the exterior of the unit before starting to dismantle. Then remove the piston stop screw located between the two fluid inlet ports.
- 2 Remove the boot from the rear of the cylinder and take out the internal circlip.
- 3 The two pistons and all their component parts may then be drawn out. Do this carefully, taking note of the order and position in which they come out.
- 4 All internal seals are fitted to the grooves in the pistons. They can be pulled off and fitted without special tools but care must be taken not to overstretch them. The primary piston is fitted with three seals all the same size and shape. The front two face forward and the third to the rear. The secondary piston has two seals, both facing forwards. The front seal is the same as those on the primary piston but the rear one is the odd one out so do not confuse it with the others.
- 5 When reassembling the pistons into the cylinder first place the cup washer, cup seal, support washer, spring plate and spring, in that order over the nose of the primary piston (to which the new secondary cup and rear seal should have been already fitted). Hold the cylinder vertical with the open end downwards and feed the whole assortment back in so that the loose items do not fall off the piston.
- 6 The secondary piston primary cup is held in location by a support washer and spring plate also. These in turn are held firm by the stop sleeve and stroke limiting screw. By undoing the stroke limiting screw inside the stop sleeve all these component parts may be released. The new seal is then easily placed in position.
- 7 When replacing the secondary piston it should be pushed far enough forward to enable the stop screw to be put in so that it fits behind the rear end of the primary piston. This is most important. It must not be fitted so that it engages the recessed part in the shank of the primary piston.
- 8 Refit the stop ring, circlip and rubber boot over the end of the cylinder.



8.4 Mounting bolt and union, master cylinder



8.6 Filling the master cylinder fluid reservoir

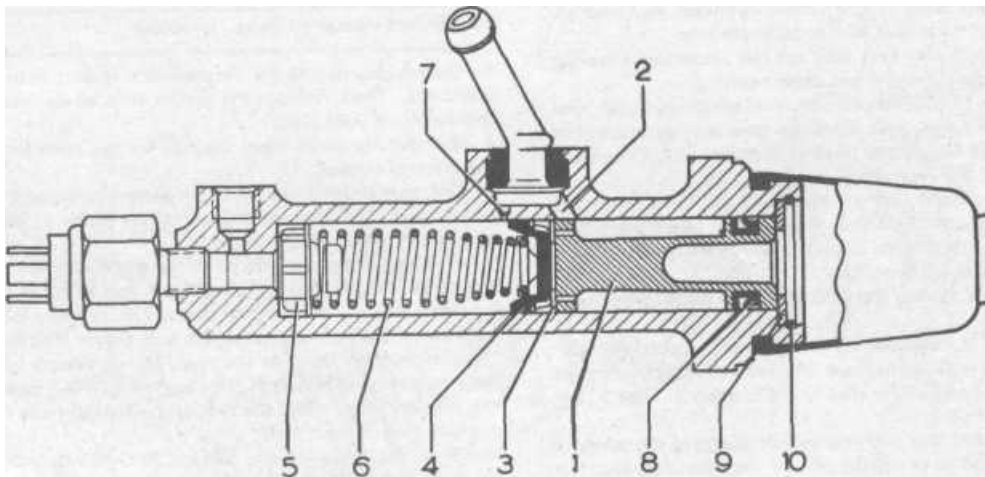


FIG. 8.9 HYDRAULIC MASTER CYLINDER (SINGLE CIRCUIT) CROSS SECTION (SEC. 9)

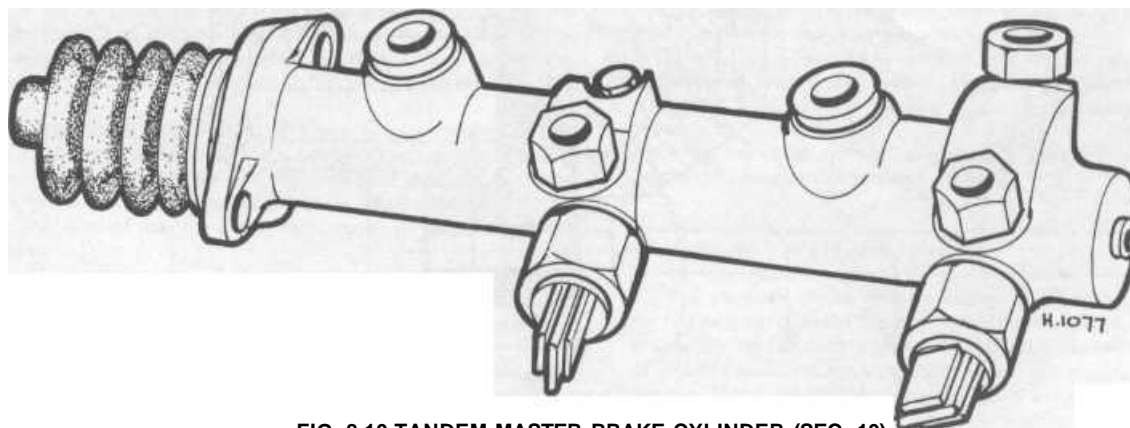
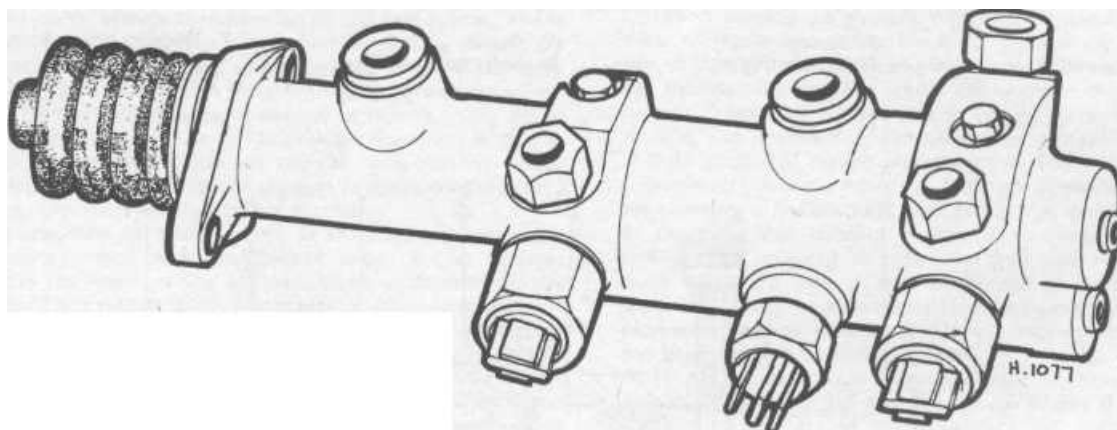
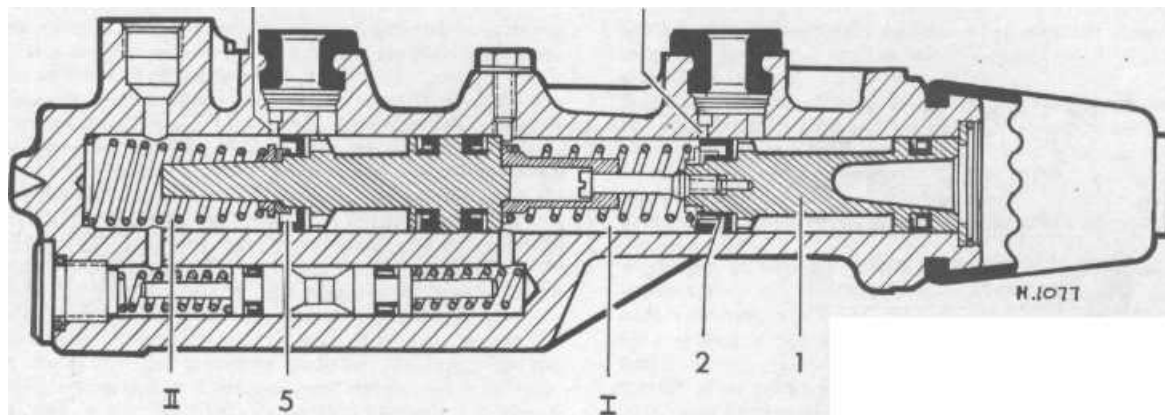
1 Piston  
2 Intake port  
3 Piston washer

4 Primary cup seal  
5 Residual pressure valve

6 Spring  
7 Compensating port

8 Secondary cup seal  
9 Stop plate  
10 Circlip





**FIG. 8.10 TANDEM MASTER BRAKE CYLINDER (SEC. 10)**

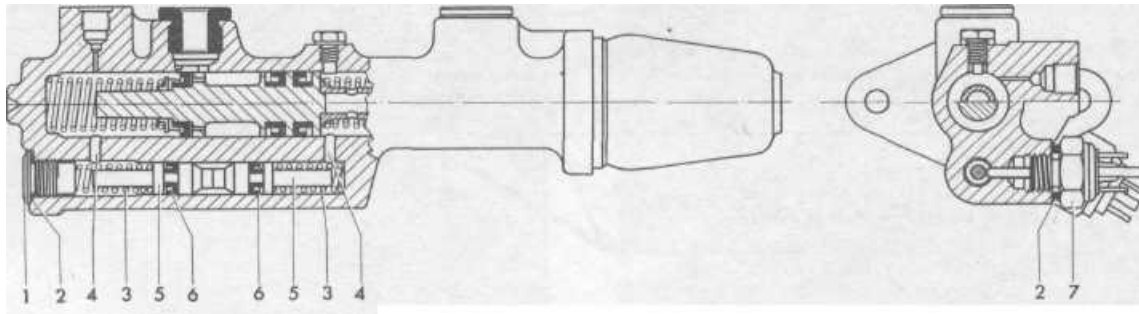
Top: Cross Section  
 1 Rear brake circuit piston  
 2 Primary cup  
 3 Port

4 Port  
 5 Primary cup

I Rear brake circuit  
 TJ Front brake circuit

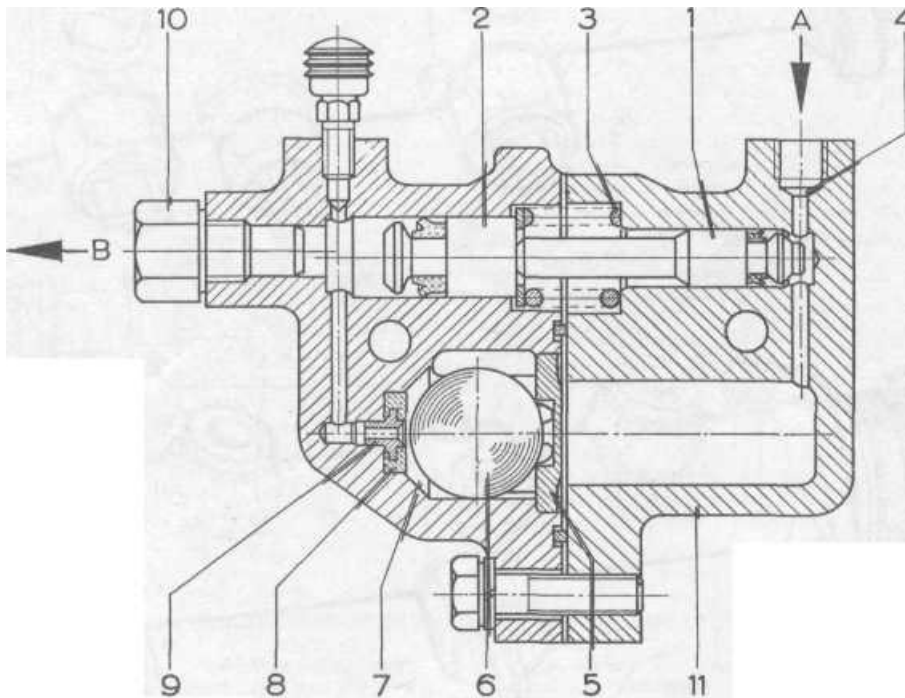
Centre: Tandem brake master cylinder with hydraulic warning device up to Chassis 219061567

Lower: Tandem brake master cylinder with electrical warning device from chassis 219061567



**FIG. 8.11 MASTER CYLINDER PRESSURE DIFFERENTIAL INDICATOR PISTON AND WARNING LAMP SWITCH; CROSS SECTION (SEC. 10)**

- |                  |                   |             |                               |
|------------------|-------------------|-------------|-------------------------------|
| 1 Plug           | 3 Spring          | 5 Piston    | 7 Warning lamp plunger switch |
| 2 Sealing washer | 4 Connecting port | 6 Seal cups |                               |



**FIG. 8.12 REAR BRAKE PRESSURE REGULATOR - CROSS SECTION**

- |                          |                       |                      |                            |
|--------------------------|-----------------------|----------------------|----------------------------|
| 1 Primary piston         | 4 Fluid inlet passage | 7 Ball chamber       | 10 Residual pressure valve |
| 2 Secondary piston       | 5 Spacer washer       | 8 Valve seal         | 11 Main housing            |
| 3 Spring between pistons | 6 Ball                | 9 Valve seat         |                            |
| A From master cylinder   |                       | B To wheel cylinders |                            |

9 Some cylinders incorporate a pressure differential warning system. This consists of a single piston held centrally in balance by the equal pressure of the two circuits.

If unequal pressure between the two circuits develops the piston moves one way or the other and operates a switch screwed into the cylinder. The switch has a plunger which engages in a groove in the piston when at rest. Movement of the piston pushes the plunger in. To remove the piston with its equilibrium springs the switch must first be screwed out of the body. Then the end plug can be removed and the internal components taken out.

Other types have a warning light operated by special brake light switches and this system is explained in Chapter 9.

For vehicles fitted with a servo assisted braking system the tandem master cylinder is further modified. The piston for the rear wheel brake circuit is of different design and a cylinder housing has a cast on neck for sealing between the piston chamber and the vacuum chamber of the brake servo unit. For details see Section 16.

### 11 Brake pressure regulator

1 On models fitted with front disc brakes a pressure regulator is installed which affects the operation of the rear brakes. This is because disc brakes have a more powerful braking action and accentuate the 'nose-dipping' attitude of the vehicle when sharp braking is used. This in turn lightens the load on the rear wheels and in certain circumstances when the vehicle is empty could cause the rear wheels to lock. The pressure regulation takes into account the rate of deceleration and the 'nose-dip' inclination and correspondingly reduces the pressure in the hydraulic system acting on the rear wheel cylinders if necessary.

2 The regulator consists of a ball in an inclined chamber and two spring loaded subsidiary pistons which act as pressure reducers. The angle of the inclined chamber depends on the position of the vehicle body. Consequently a loaded vehicle will not increase the angle so much as an empty one. When braking occurs the ball is thrown forward and depending on the rate of deceleration and the angle up which it has to roll it shuts off the direct fluid flow to the rear brake cylinders. Pressure is then applied to two intermediate pistons of different diameters, with a spring between them which effectively reduces the output pressure to the rear brakes.

3 Malfunction of the unit will result in either locking of the rear wheels or, at the other extreme, ineffective braking. It is not possible to test the regulator accurately without having the suitable hoses and gauges up to 1500 p.s.i. to connect to the front and rear brake circuits. When the front circuit pressure is 1420 p.s.i. the regulated pressure at the rear should be 780 - 925 p.s.i.

4 The regulator is mounted on the side frame member on the inside at the rear underneath. It is easily removed and replaced. The hydraulic line unions are disconnected and the securing screws taken out. The residual pressure valve screwed into the front end should be removed for fitting to a new unit as required.

### 12 Hydraulic fluid lines and hoses - examination, and renewal

1 Regular examination of the pipes which carry the pressurised fluid from the master cylinder to the four wheel cylinders is very important. Any sudden leak due to fracture or corrosion will result in loss of pressure and the front or rear brakes will be inoperative except for the handbrake which is inadequate for driving purposes.

2 Trace the routes of all the rigid pipes and wash or brush away accumulated dirt. If the pipes are obviously covered with some sort of underseal compound do not disturb it. Examine for signs of kinks or dents which could have been caused by flying stones. Any instances of this mean that the pipe section should be renewed but before actually taking it out read the rest of this

section. Any unprotected sections of pipe which show signs of corrosion or pitting on the outer surfaces must also be considered for renewal.

3 Flexible hoses, running to each of the front wheels and from the underbody to each rear wheel should show no external signs of chafing or cracking. Move them about and see if surface cracks appear. Also if they feel stiff and in-flexible or are twisted they are nearing the end of their useful life. If in any doubt renew the hoses. Make sure also that they are not rubbing against the bodywork.

4 Before attempting to remove any pipe for renewal it is important to be sure that you have a replacement source of supply within reach if you do not wish to be kept off the road for too long. Pipes are often damaged on removal. If a Volkswagen agency is near you may be reasonably sure that the correct pipes and unions are available. If not, check first that your local garage has the necessary equipment for making up the pipes and has the correct metric thread pipe unions available. The same goes for flexible hoses.

5 Where the couplings from rigid to flexible pipes are made there are support brackets and the flexible pipe is held in place by a 'U' clip which engages in a groove in the union (photo). The male union screws into it. Before getting the spanners on, soak the unions in penetrating fluid as there is always some rust or corrosion binding the threads. Whilst this is soaking in, place a piece of plastic film under the fluid reservoir cap to minimise loss of fluid from the disconnected pipes. Hold the hexagon on the flexible pipe coupling whilst the union on the rigid pipe is undone. Then pull out the clip to release both pipes from the bracket. For flexible hose removal this procedure will be needed at both ends. For a rigid pipe the other end will only involve unscrewing the union from a cylinder or connector. When you are renewing a flexible hose, take care not to damage the unions of the pipes that connect into it. If a union is particularly stubborn be prepared to renew the rigid pipe as well. This is quite often the case if you are forced to use open ended spanners. It may be worth spending a little money on a special pipe union spanner which is like a ring spanner with a piece cut out to enable it to go round the tube.

6 If you are having the new pipe made up, take the old one along to check that the unions and pipe flaring at the ends are identical.

7 Replacement of the hoses or pipes is a reversal of the removal procedure. Precautions and care are needed to make sure that the unions are correctly lined up to prevent cross threading. This may mean bending the pipe a little where a rigid pipe goes into a fixture. Such bending must not, under any circumstances, be too acute, otherwise the pipe will kink and weaken.

8 When fitting flexible hoses take care not to twist them. This can happen when the unions are finally tightened unless a spanner is used to hold the end of the flexible hose and prevent twisting.

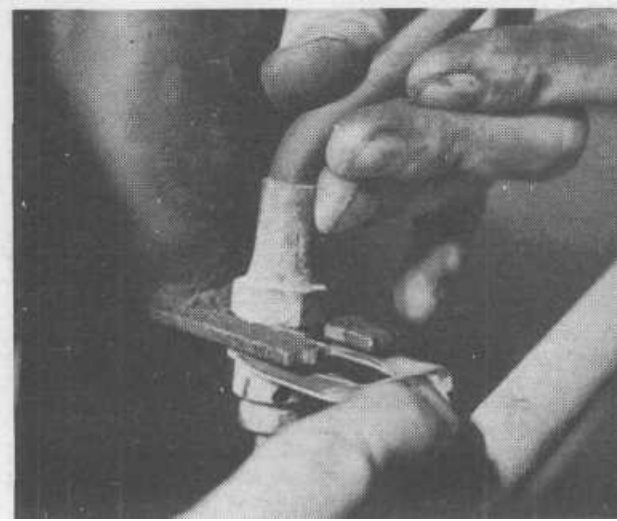
9 After removal or slackening of a brake pipe union the hydraulic system must be bled.

### 13 Hydraulic brake system - bleeding

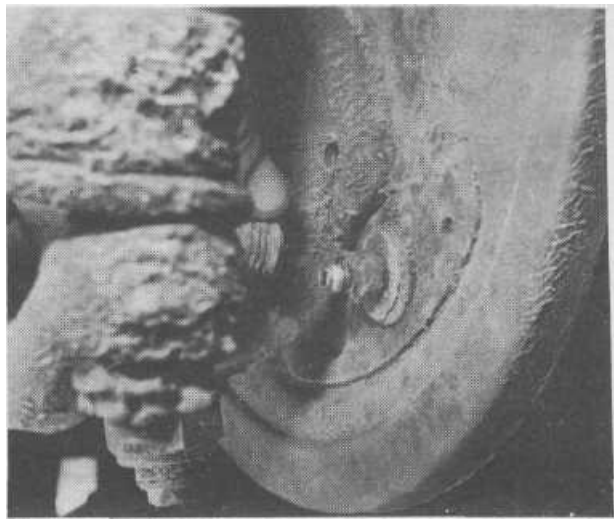
1 The purpose of the process known as bleeding the brakes is to remove air bubbles from the hydraulic system. Air is compressible - hydraulic fluid is not. Bleeding should be necessary only after work on the hydraulic system has allowed air into the system. If it is found necessary to bleed brakes frequently then there is something wrong and the whole system should be checked through to find where the air is getting into the system. Vehicles left unused for a long time may also require brake bleeding before full efficiency is restored.

2 Normally, if work has been carried out at the extremities of the system - e.g. at wheel cylinders or adjacent pipes, then it should only be necessary to bleed that particular section. Work on the master cylinder, however, would call for all four wheels to be bled.

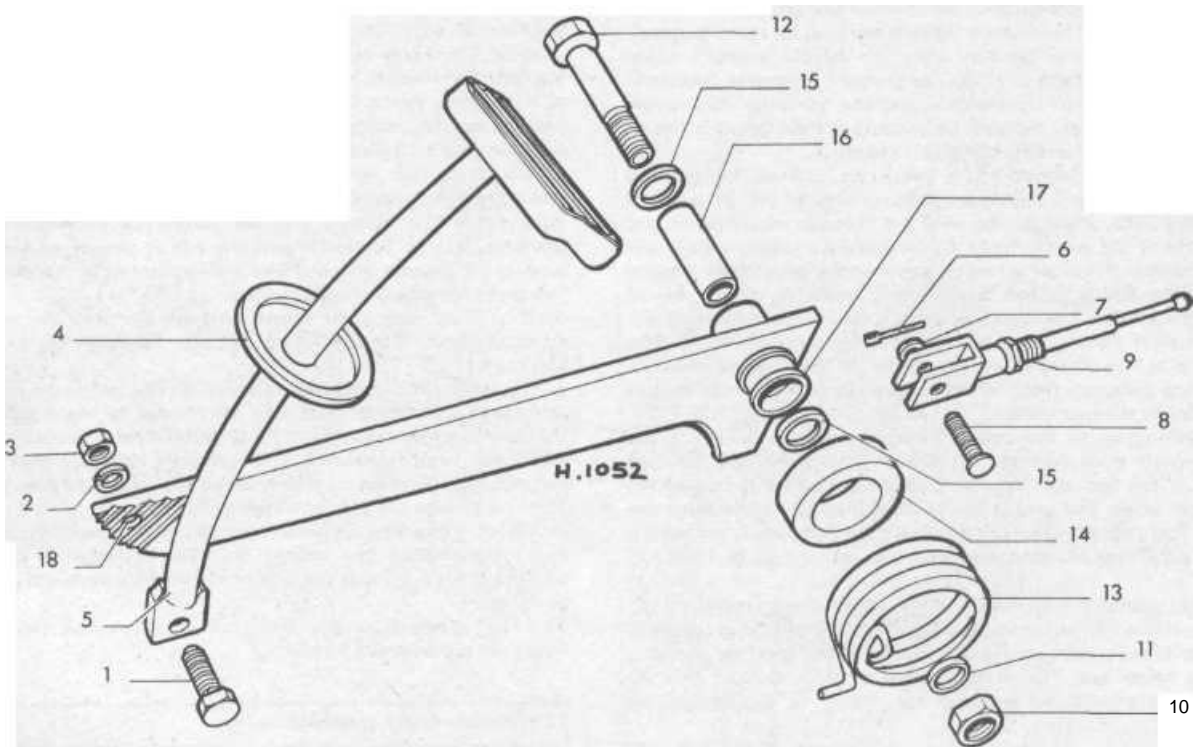
3 Before starting, make sure you have an adequate supply of



12.5 Flexible hose mounting bracket and clip



13.4 Bleed nipple cap removed, right hand front wheel



**FIG. 8.13 BRAKE PEDAL CLUSTER - EARLY VERSIONS R.H.D. AND ALL VERSIONS L.H.D. (SEC. 14)**

1 Bolt  
2 Lock washer  
3 Nut  
4 Seal

5 Brake pedal  
6 Split pin  
7 Washer  
8 Pin

9 Push rod  
10 Nut  
11 Lock washer  
12 Bolt  
13 Return spring

14 Plastic ring  
15 Seal  
16 Mounting tube  
17 Bush  
18 Brake pedal lever

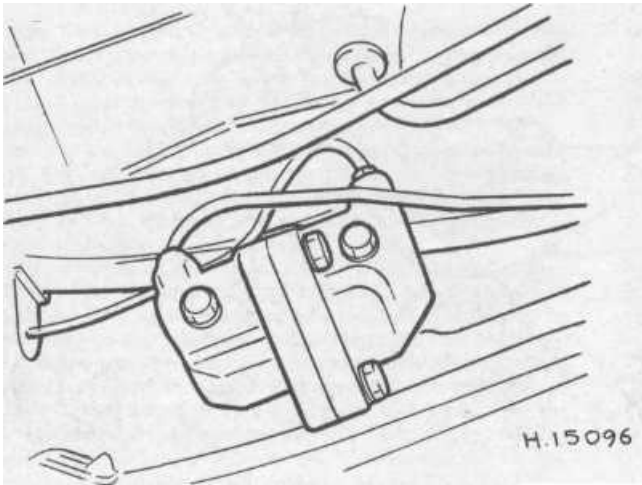


FIG 8.14 TYPICAL BRAKE PRESSURE REGULATOR  
(Sec. 11)

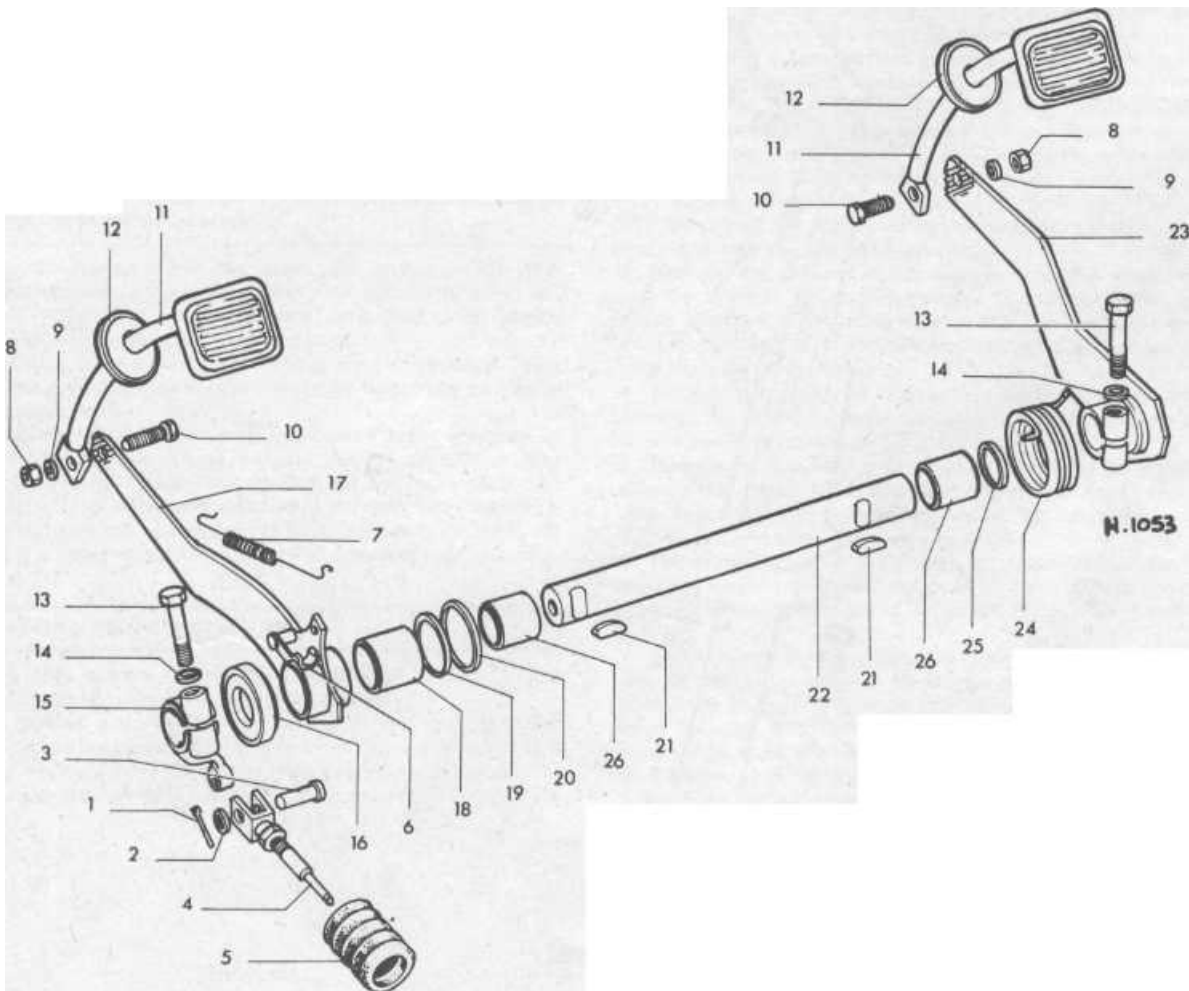
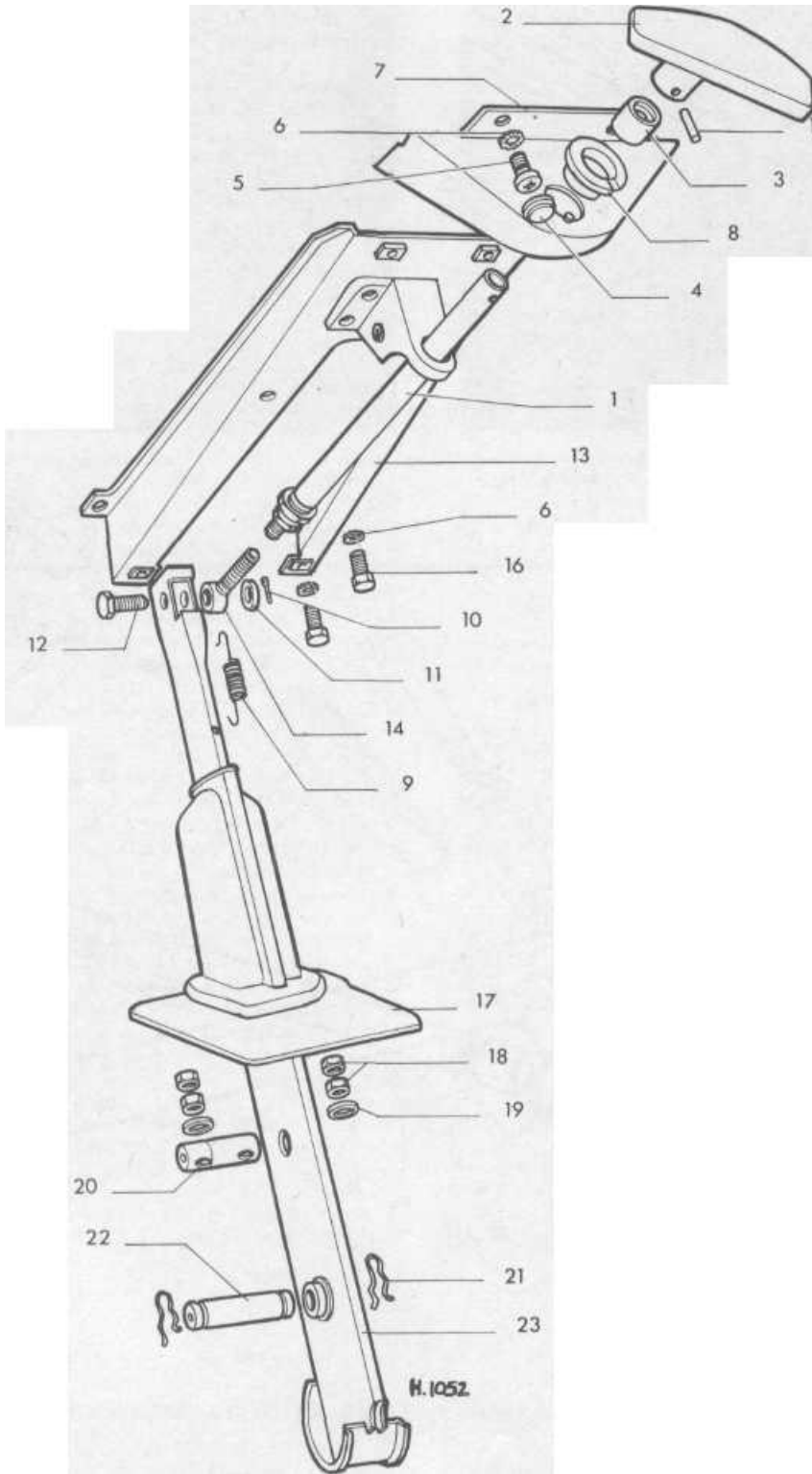


FIG. 8.15 BRAKE (AND CLUTCH) PEDAL CLUSTER - LATE VERSIONS R.H.D. (SEC. 14)

- |                       |                 |                      |                  |
|-----------------------|-----------------|----------------------|------------------|
| 7 Split pin           | 7 Return spring | 13 Clamp screw       | 20 Thrust washer |
| 2 Washer              | 8 Nut           | 14 Lock washer       | 21 Woodruff key  |
| 3 Clevis pin          | 9 Lock washer   | 15 Brake pedal lever | 22 Shaft         |
| 4 Push rod            | 10 Bolt         | 16 Seal              | 23 Brake pedal   |
| 5 Master cylinder cap | 11 Push rod     | 17 Clutch pedal      | 24 Return spring |
| 6 Pin and clip        | 12 Seal         | 18 Bush              | 25 Seal          |
|                       |                 | 19 Seal              | 26 Bush          |



**FIG. 8.16 HANDBRAKE LEVER ASSEMBLY (SEC. 15)**

- 1 Roll pin
- 2 Handle
- 3 Ratchet bar stop
- 4 Cover
- 5 Screw
- 6 Lock washer

- 7 Trim plate
- 8 Guide sleeve
- 9 Spring
- 10 Split pin
- 11 Washer
- 12 Pin

- 13 Ratchet bar
- 14 Eye bolt
- 15 Screw
- 16 Ratchet bar bracket
- 17 Boot
- 18 Nut

- 19 Washer
- 20 Anchor pin
- 21 Spring clip
- 22 Pin
- 23 Handbrake lever



the proper fluid, a clean receptacle and a tube which will fit over the bleed nipple securely and which is conveniently long enough. A useful device is the tube which is fitted with a non-return valve. This avoids the necessity of keeping the other end of the tube submerged in liquid whilst bleeding is in progress.

4 Clean off the bleed nipple (or pull off the protective cap) (photo). Put about 1 inch depth of fluid in the receptacle (a salad cream jar is ideal and needs less fluid!). Connect the pipe to the nipple and put the other end in the jar and undo the nipple about half a turn - no more is necessary.

5 A second person is needed to operate the brake pedal at your instruction. The pedal should be depressed smartly one full stroke to the floor and allowed to return slowly. This should be repeated until no more bubbles emerge from the tube in the jar. Smart operation of the pedal ensures that the air is forced along the pipe rather than by-passed. Keep a watch on the level of fluid in the reservoir. If it gets too low it will let air into the master cylinder and then you will have to bleed all four wheels.

6 Once all the air is expelled, the best moment to tighten the bleed nipple is during the return stroke of the pedal.

7 Repeat the procedure for each wheel as necessary. Do not put fluid bled out of the system back in. Always use fresh.

8 It is considered by many a good idea to completely replenish the brake fluid, by bleeding, at regular intervals. Such intervals would be two years or 30,000 miles, whichever came first. Renewal of the wheel cylinder seals at the same time would be well worth the small cost and time involved.

#### 14 Brake and clutch pedal assembly

1 Prior to August 1969 the brake and clutch pedals were mounted and supported independently for both RHD and LHD vehicles. After that, RHD vehicles only, had both pedals supported and pivoting on a common shaft.

2 There are few occasions when dismantling is necessary. These are in the case of a broken return spring or severely worn bushes for the pivot shaft.

3 Independently mounted pedals are more easily removed, as the pivot is threaded at one end and secured with a nut. The RHD versions with a common shaft have the brake pedal and brake pedal lever keyed and clamped to the shaft with the clutch pedal pivoting on it in between. If anything has to be taken off the shaft a puller might be necessary to draw items off the keys.

#### 15 Handbrake cables - renewal

1 The cable to each of the rear wheels is independent of the other and can be renewed if necessary separately.

2 To remove either cable first lift the rubber boot over the cable ends in the driving cab - just in front of the gear lever - and remove the nuts from the end of the cable (photo 2.7, page 121).

3 Remove the rear brake drum and then unhook the end of the

cable from the lever on the shoes.

4 Release the clip which clamps the cable outer sleeve to the backplate, and then draw the cable clear of the backplate. The cable may then be drawn out from the rear of the guide tube.

5. When fitting new cables ensure that they are well greased. When fitting the cable clip to the brake back plate the curved guide should face upwards and forwards (photo).

6 The handbrake lever assembly does not usually need dismantling. If it does, first detach the brake cables and remove the ashtray from the fascia panel. Then drive out the roll pin securing the handle to the ratchet bar. After that removal of the ratchet bar bracket securing bolts and the pins and spring will enable the various parts to be taken clear.

#### 16 Brake servo mechanism

1 The brake servo is operated by the brake pedal and is worked by the pressure differential between the vacuum in the intake manifold and atmospheric pressure. The servo mechanism is fitted on the end of a modified tandem master cylinder. It is possible to fit a servo system to existing vehicles not so fitted, but this work should be done only by the VW agent.

2 To remove the servo mechanism first clean all dirt from the brake master cylinder and the brake servo. Remove as much brake fluid as possible from the refill container using a siphon that has not been used for anything else except brake fluid.

Take off the pipe from the fluid reservoir (catch any fluid left) disconnect the brake pipes from the tandem master cylinder and disconnect the stop light switches.

3 Remove the tandem master cylinder from the servo unit. It may be tight so be careful, damage to the rear brake circuit piston shaft will give trouble later on. Remove the hose from the vacuum cylinder, take off the cover plate, and disconnect the air hose from the connecting pipe.

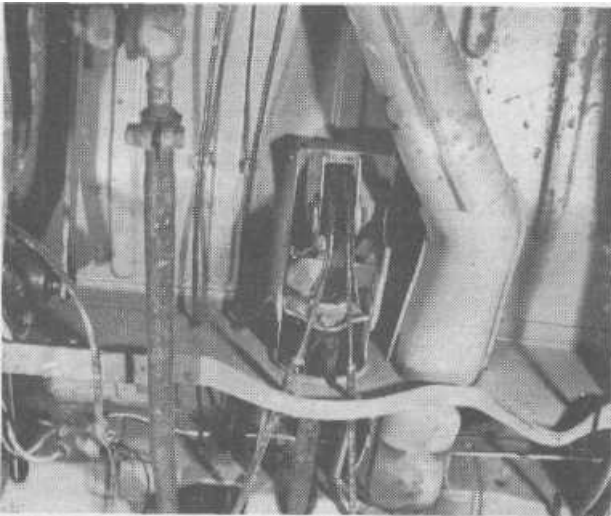
4 Slacken the push rod locknut on the brake servo and disconnect the push rod from the brake pedal. Remove the brake servo from its bracket and pull it away to the rear.

5 Reassembly is a reverse of removal; install the servo unit and connect the hoses, fit the tandem master cylinder to the servo unit, reconnect the brake lines, adjust the operating rod (see Section 10) and bleed the hydraulic system.

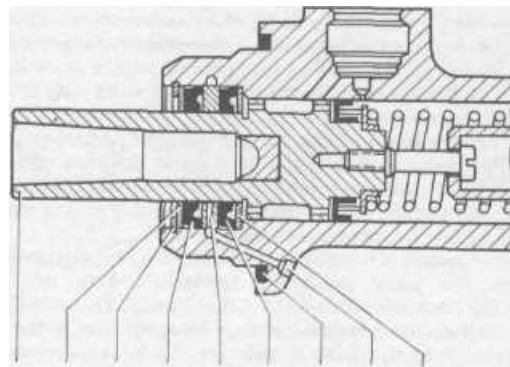
6 Repairs to the servo are limited to replacement of the filter damping washer, boot and sealing ring. These should always be replaced when the servo is removed. No further repairs are possible.

7 To dismantle the servo take the retaining ring from the boot, remove the circlip and pull off the air connection, and pull the boot from its seating. Using a screwdriver lever the cap off the valve housing. The damper ring and the filter may then be removed from the valve housing.

8 Reassembly is the reverse of dismantling. Be careful that the slits in the filter and damping ring are 180° apart.



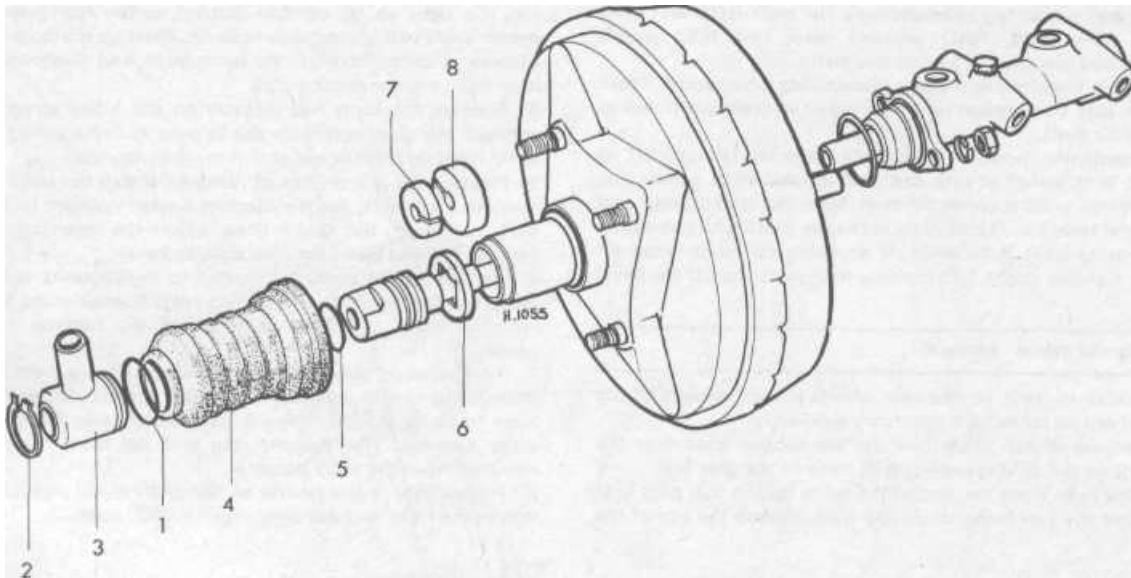
15.5 View of the handbrake cable from below



7 3 2 4 5 4 1 6 3

**FIG. 8.17 MODIFICATION TO TANDEM BRAKE MASTER CYLINDER FOR SERVO ASSISTED SYSTEM (SEC. 16)**

- |           |                     |
|-----------|---------------------|
| 7 Seal    | 5 Washer            |
| 2 Circlip | 7 Rear brake piston |
| 3 Washer  |                     |



**FIG. 8.18 SERVO MECHANISM. EXPLODED VIEW (SEC. 16)**

- |                  |                        |        |                |
|------------------|------------------------|--------|----------------|
| 1 Retaining ring | 3 Air connection       | 5 Seal | 7 Damping ring |
| 2 Circlip        | 4 Rubber dust excluder | 6 Cap  | 8 Filter       |

## 17 Fault diagnosis and remedies

Before diagnosing faults in the brake system check that any irregularities are not caused by:

- 1 Uneven and incorrect tyre pressures
- 2 Incorrect 'mix' of radial and cross-ply tyres
- 3 Wear in the steering mechanism
- 4 Defects in the suspension and dampers
- 5 Misalignment of the body frame

Symptom	Reason/s	Remedy
Pedal travels a long way before the brakes operate	Brake shoes set too far from the drums	Adjust the brake shoes to the drums. (This applies equally where disc brakes are fitted but only the rear drums need adjustment).
Stopping ability poor, even though pedal pressure is firm	Linings and/or drums badly worn or scored One or more wheel hydraulic cylinders seized resulting in some brake shoes not pressing against the drums (or pads against discs) Brake linings contaminated with oil	Dismantle, inspect and renew as required. Dismantle and inspect wheel cylinders. Renew as necessary.
	Wrong type of linings fitted	Renew linings and repair source of oil contamination. Verify type of material which is correct for the car and fit it.
	Brake shoes wrongly assembled One of the dual hydraulic circuits is leaking resulting in only front or only rear brakes in operation	Check for correct assembly. Examine hydraulic system for signs of leaks.
Car veers to one side when the brakes are applied	Brake linings on one side are contaminated with oil Hydraulic wheel cylinder(s) on one side partially or fully seized A mixture of lining materials fitted between sides Unequal wear between sides caused by partially seized wheel cylinders	Renew linings and stop oil leak. Inspect wheel cylinders for correct operation and renew as necessary. Standardise on type of linings fitted. Check wheel cylinders and renew linings and drums as required.
	Air is present in the hydraulic system	Bleed the hydraulic system and check for any signs of leakage.
Pedal feels spongy when the brakes are applied	Air is present in the hydraulic system	Bleed the hydraulic system and check for any signs of leakage.
Pedal feels springy when the brakes are applied	Brake linings not bedded into the drums (after fittings new ones)	Allow time for new linings to bed in after which it will certainly be necessary to adjust the shoes to the drums as pedal travel will have increased. Retighten mounting bolts.
	Master cylinder or brake backplate mounting bolts loose Severe wear in brake drums causing distortion when brakes are applied	Renew drums and linings.
Pedal travels right down with little or no resistance and brakes are virtually non-operative. (See note at end)	Leak in both hydraulic system circuits resulting in lack of pressure for operating wheel cylinders If no signs of leakage are apparent all the master cylinder internal seals are failing to sustain pressure.	Examine the whole of the hydraulic system and locate and repair leaks. Test after repairing each and every leak sources. Overhaul master cylinder.
Binding, juddering, overheating	One or a combination of causes given in the foregoing sections	Complete and systematic inspection of the whole braking system.
Servo mechanism (a) pedal pressure high no servo assistance	Vacuum line leaking Diaphragm leaking Master cylinder leaking	Tighten clamps New servo required. Check piston shaft for damage install sealing ring and cups.
	Damaged piston shaft in master cylinder	Repair master cylinder.

Note: Due to the safety feature of dual hydraulic circuits the possibility of both circuits failing simultaneously is very remote indeed.

# Chapter 9 Electrical system

For modifications, and information applicable to later models, see Supplement at end of manual

## Contents

General description ... .. 1	Direction indicators - fault tracing and repair ... .. 16
Battery - removal and replacement ... .. 2	Windscreen wipers - fault finding ... .. 17
Battery - maintenance and inspection ... .. 3	Windscreen wiper mechanism - removal and replacement ... .. 18
Electrolyte replenishment ... .. 4	Windscreen wiper motor - repair ... .. 19
Battery charging ... .. 5	Windscreen wiper spindle bearings - renewal ... .. 20
Dynamo - routine checking ... .. 6	Windscreen wiper switch and washer valve - removal and replacement ... .. 21
Dynamo - testing - general ... .. 7	Windscreen washer ... .. 22
Dynamo - no load regulated voltage check ... .. 8	Stoplamps and dual brake circuit warning lamp ... .. 23
Dynamo - no load unregulated voltage check ... .. 9	Horn ... .. 24
Dynamo - current output check and reverse current check ... .. 10	Headlamps, side lamps and rear lamps - bulbs and adjustment ... .. 25
Regulator - removal and replacement ... .. 11	Instrument panel and instruments ... .. 26
Dynamo - removal, repair and replacement ... .. 12	Steering column ignition/starter switch ... .. 27
Starter motor - testing, removal and replacement ... .. 13	Turn signal switch ... .. 28
Starter motor - repair ... .. 14	Computer diagnosis ... .. 29
Fuses and relays ... .. 15	Wiring diagrams ... .. 30

## Specifications

### Generator

Type ... ..	Bosch or V.W (D.C)
Max mum current (amps) ...	30 or 38*
Cut-in speed ...	1450 or 1300* rpm
Commutator minimum diameter ...	32.8 mm (1.29 in)
Segment insulation undercut	0.5 mm (0.02 in)
Brush length ...	To be greater than the holder

\* Higher output up to chassis 218 202 251

### Regulator

Type ... ..	Bosch or VW, matched to generator
-------------	-----------------------------------

### Starter motor

Type ... ..	Bosch or VW pre-engaged
Rating	12v0.7 H.P.

### Wiper motor

Type ... ..	2 speed, worm drive
Current consumption	Low speed 2.5 amps
	High speed 3.5 amps

### Lamps (12 volt)

Headlamp bulb	45/40 w
Sealed beam unit	50/40 w (12.8 v)
Turn signal bulb	21 w
Brake/tail light bulb	21/5 w
Rear number plate bulb	10 w
Reverse light bulb	25 w
Interior light bulb	10 w
Parking light ...	4 w
Warning light	1.2 w
Heated rear screen	60 w

Fuses	1967	1968-89	1970	1971-72
No of fuses	8	10	12	12
No1	Left headlamp. Low beam	Brake lights Horn Flashers	Interior light	Parking lights Right rear lamp Number plate
No 2	Right headlamp. Low beam	Windscreen wipers	Interior light Emergency flasher	Left rear light
No 3	Left head lamp. Main beam	Left head lamp. main beam	Horn Stoptlights	Right head lamp low beam
No 4	Right head lamp. Main beam	Right head lamp main beam	Direction indicators	Left head lamp low beam
No 5	Left rear light	Left headlamp low beam	Windscreen wipers	Right head lamp main beam
No 6	Right rear light	Right headlamp low beam	Spare	Left head lamp main beam
No 7	Brake lights Direction indicators	Right rear light Number plate	Left headlamp main beam	Spare
No 8	Windscreen wipers Horn Interior lights	Left rear light	Right head lamp main beam	Interior light Emergency flasher
No 9		Emergency flasher Interior lights	Left head lamp. Low beam	Interior light Ignition buzzer
No10		Radio	Right head lamp. Low beam	Horn Brake lights
No11			Left hand rear lights	Windscreen wipers
No12			Right hand rear lights	Direction indicators Brake lights Fuel gauge

Identification; Red 16 amp. ~~White 8 amp~~

NOTE: The fuse box arrangements given are a typical selection. There are so many different wiring circuits that it will always pay dividends to check which fuse controls which circuit when everything is working, quietly at home. This can easily be done by switching everything on and removing the fuses in turn to see what stops working and starts when the fuse is put back. Fuses usually blow in snow storms or in heavy traffic. It is useful to know which one to pull out when the horn will not stop operating.

Torque wrench settings	lbs/ft	mkg
Generator pulley nut	.43	6.0
Generator fan nut	.43	6.0

## 1 General description

The system is 12 volt comprising:

A battery with negative earth mounted at the right side of the engine compartment.

A D.C. generator mounted on a pedestal above the engine driven by a belt from the crankshaft pulley. The generator armature shaft also carries the cooling fan at the opposite end.

A voltage regulator and cut-out unit mounted behind the air cleaner in the engine compartment.

A starter motor of the pre-engaged type (one which meshes with the flywheel ring gear before the power is switched to the motor).

The battery provides the necessary power storage source for operating the starter and providing the current to operate the lights, accessories and ignition circuit. It is kept in a state of full charge by the generator. The regulator controls the generator output. This control automatically adjusts according to the state of charge of the battery, the electrical load demanded and engine revolutions in such a way that the generator is never overloaded and the battery never over or undercharged. It must be appreciated that indiscriminate additions of electrical accessories can upset this balance.

The starter motor is mounted on the transmission casing. Drive pinion engagement and switching is effected by a solenoid. The pinion is engaged by the solenoid before the same solenoid switches current to the starter motor itself. The pinion is driven through a one-way roller clutch to obviate any damage from over-run.

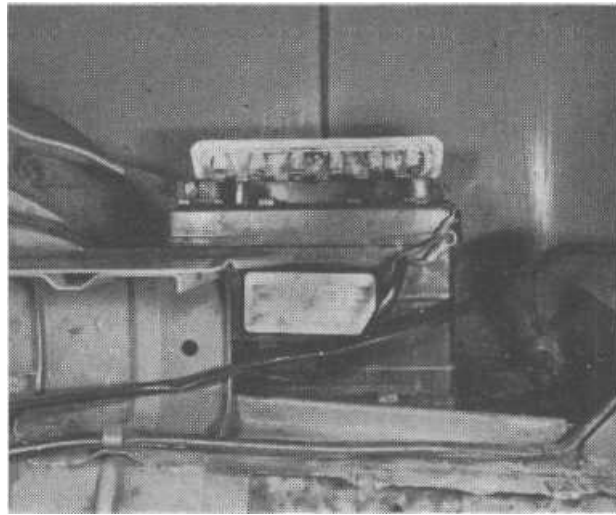
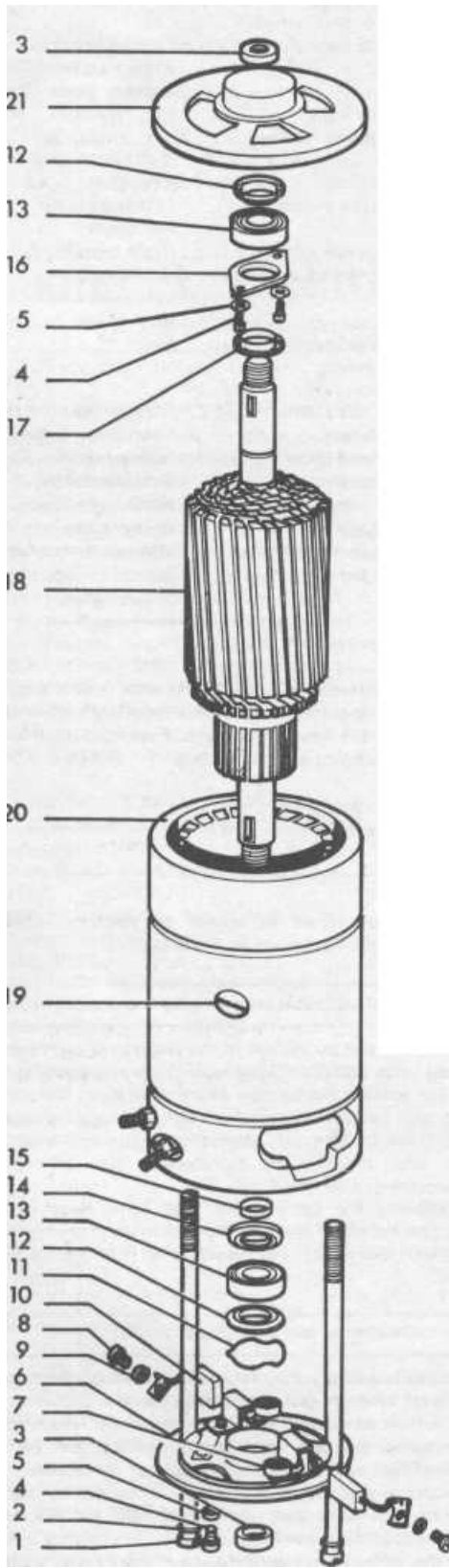
Later models are wired to accept an electrical diagnosis system, details of which are given in the chapter.

## 2 Battery - removal and replacement

- 1 The battery is fixed by clamps in the engine compartment.
- 2 On models with computer diagnosis there is a small lead to a connection for sensing the battery electrolyte level. Detach this.
- 3 Unclamp the battery terminals (earth or negative terminal first) and lift the battery out vertically to prevent electrolyte spillage. On later models, the air cleaner must be removed before the battery can be lifted out.
- 4 When replacing the battery see that both terminals and terminal clamps are clean and free from corrosion or deposits of any sort. Smear them with petroleum jelly (not grease) before connection.

## 3 Battery - maintenance and inspection

- 1 Normal weekly battery maintenance consists of checking the electrolyte level of each cell to ensure that the separators are covered by  $\frac{1}{8}$  inch of electrolyte. If the level has fallen, top up the battery using distilled water only. Do not overfill. If a battery is overfilled or any electrolyte spilled, immediately wipe away the excess as electrolyte attacks and corrodes any metal it comes into contact with very rapidly. As the battery is not conveniently accessible a small hand mirror is essential in order to see into the cells. A suitably shaped container, such as a flexible plastic bottle with an extended spout is needed to add distilled water with some measure of control. If you have neither of these take the battery out to check it.



2.1 Disconnect the battery

**FIG. 9.1 DYNAMO COMPONENTS (TYPICAL LAYOUT) (SEC. 12)**

- 1 Through bolt
- 2 Lock washer
- 3 Spacer ring
- 4 Screw
- 5 Lock washer
- 6 Commutator end plate
- 7 Brush spring
- 8 Screw
- 9 Lock washer
- 10 Carbon brush
- 11 Lock washer
- 12 Splash shield
- 13 Ball bearing
- 14 Splash shield
- 15 Thrust washer
- 16 Retaining plate
- 17 Splash shield
- 18 Armature
- 19 Pole shoe screw
- 20 Field coil
- 21 Fan end plate



2 As well as keeping the terminals clean and covered with petroleum jelly, the top of the battery and especially the top of the cells, should be kept clean and dry. This helps prevent corrosion and ensures that the battery does not become partially discharged by leakage through dampness and dirt.

3 Once every three months, remove the battery and inspect the battery tray and battery leads for corrosion (white fluffy deposits on the metal which are brittle to touch). If any corrosion is found, clean off the deposits with ammonia and paint over the clean metal with an anti-rust/anti-acid paint.

4 At the same time inspect the battery case for cracks. If a crack is found clean and plug it with one of the proprietary compounds marketed by firms, such as Holts, for this purpose. If leakage through the crack has been excessive then it will be necessary to refill the appropriate cell with fresh electrolyte as detailed later. Cracks are frequently caused in the top of the battery cases by pouring in distilled water in the middle of winter after instead of BEFORE a run. This gives the water no chance to mix with the electrolyte and so the former freezes and splits the battery case.

5 If topping up the battery becomes excessive and the case has been inspected for cracks that could cause leakage, but none are found, the battery is being over-charged and the regulator will have to be checked.

6 With the battery on the bench at the three monthly interval check, measure its specific gravity with a hydrometer to determine the state of charge and condition of the electrolyte. There should be very little variation between the different cells and if a variation in excess of 0.025 is present it will be due to either:

a) Loss of electrolyte from the battery at some time caused by spillage or a leak, resulting in a drop in the specific gravity of the electrolyte when the deficiency was replaced with distilled water instead of fresh electrolyte.

b) An internal short circuit caused by buckling of the plates or a similar malady pointing to the likelihood of total battery failure in the near future.

7 The correct readings for the electrolyte specific gravity at various states of charge and conditions are:

	Temperate	Tropical
Fully charged	1.285	1.23
Half charged	1.20	1.14
Discharged	1.12	1.08

#### 4 Electrolyte replenishment

1 If the battery is in a fully charged state and one of the cells maintains a specific gravity reading which is 0.025 or more lower than the others, and a check of each cell has been made with a voltage meter to check for short circuits (a four to seven second test should give a steady reading of between 1.2 to 1.8 volts), then it is likely that electrolyte has been lost from the cell with the low reading at some time.

2 Top the cell up with a solution of 1 part sulphuric acid to 2.5 parts of water. If the cell is already fully topped up draw some electrolyte out of it with a syphon.

3 When mixing the sulphuric acid and water NEVER ADD WATER TO SULPHURIC ACID - always pour the acid slowly onto the water in a glass container. IF WATER IS ADDED TO SULPHURIC ACID IT WILL EXPLODE.

4 Continue to top up the cell with the freshly made electrolyte and then recharge the battery and check the hydrometer readings.

#### 5 Battery - charging

1 In winter time when heavy demand is placed upon the battery, such as when starting from cold, and much electrical equipment is continually in use, it is a good idea occasionally to have the battery fully charged from an external source at the rate of 3.5 to 4 amps.

2 Continue to charge the battery at this rate until no further

rise in specific gravity is noted over a four hour period.

3 Alternatively, a trickle charger, charging at the rate of 1.5 amps, can be safely used overnight.

4 Specially rapid 'boost' charges which are claimed to restore the power of the battery in 1 to 2 hours are not recommended as they can cause serious damage to the battery plates through overheating.

5 While charging the battery note that the temperature of the electrolyte should never exceed 100°F.

6 Make sure that your charging set and battery are set to the same voltage.

#### 6 Dynamo - routine checking

1 The main requirement is maintaining the fan belt at the proper tension as described in Chapter 2.

2 Both armature shaft bearings are sealed and additional lubrication is not possible as a frequent routine.

3 Keep an eye on the condition of the commutator and carbon brushes. These can be seen through the aperture in the casing once the cover at the fan belt end is loosened and moved back. The brushes should protrude from the upper ends of their holders. If they do not then they are getting short and need renewal. The commutator should not show serious signs of discoloration and there should be no indication of a channel worn where the brushes track.

#### 7 Dynamo - testing - general

1 If the ignition warning light does not go out when the engine is running at a fast tickover or only goes out at high revolutions, it is usually due to a fault in either dynamo or regulator. If checked and dealt with quickly it is often possible to avoid expensive repairs.

2 First examine the dynamo brushes and the surface of the commutator. If the brushes are worn or commutator dirty it is possible to deal with them without removing the dynamo from the car. Section 12 explains how to remove the brushes and clean the commutator.

3 In order to carry out further checks a voltmeter is required.

#### 8 Dynamo - no load regulated voltage check

1 Disconnect the lead from terminal 61/B+ on the regulator (situated behind the carburettor air cleaner) (photo 11.1), and make sure the end cannot touch any nearby part and short to earth.

2 Connect the positive lead from the voltmeter to terminal 61/B+ on the regulator and the negative lead to earth (Fig. 9.2A).

3 Start the engine and increase speed slowly to a fast tickover. The voltmeter should rise to a reading of 13 - 14 volts and stay there. If there is no reading the fault is most likely in the generator. If the reading is incorrect then the regulator is most probably at fault. Nevertheless both could be faulty in either case.

#### 9 Dynamo - no load unregulated voltage check

1 This check will tell you if the generator is at fault and must be done quickly or you could damage an otherwise sound generator.

2 Disconnect the leads from terminals DF and D+ on the generator (Fig. 9.2B) (photo 10.2).

3 Connect the voltmeter + terminal to the D+ terminal on the generator and the voltmeter negative terminal to the D— terminal.

4 Start the engine. At a fast tickover - say 1500 generator rpm

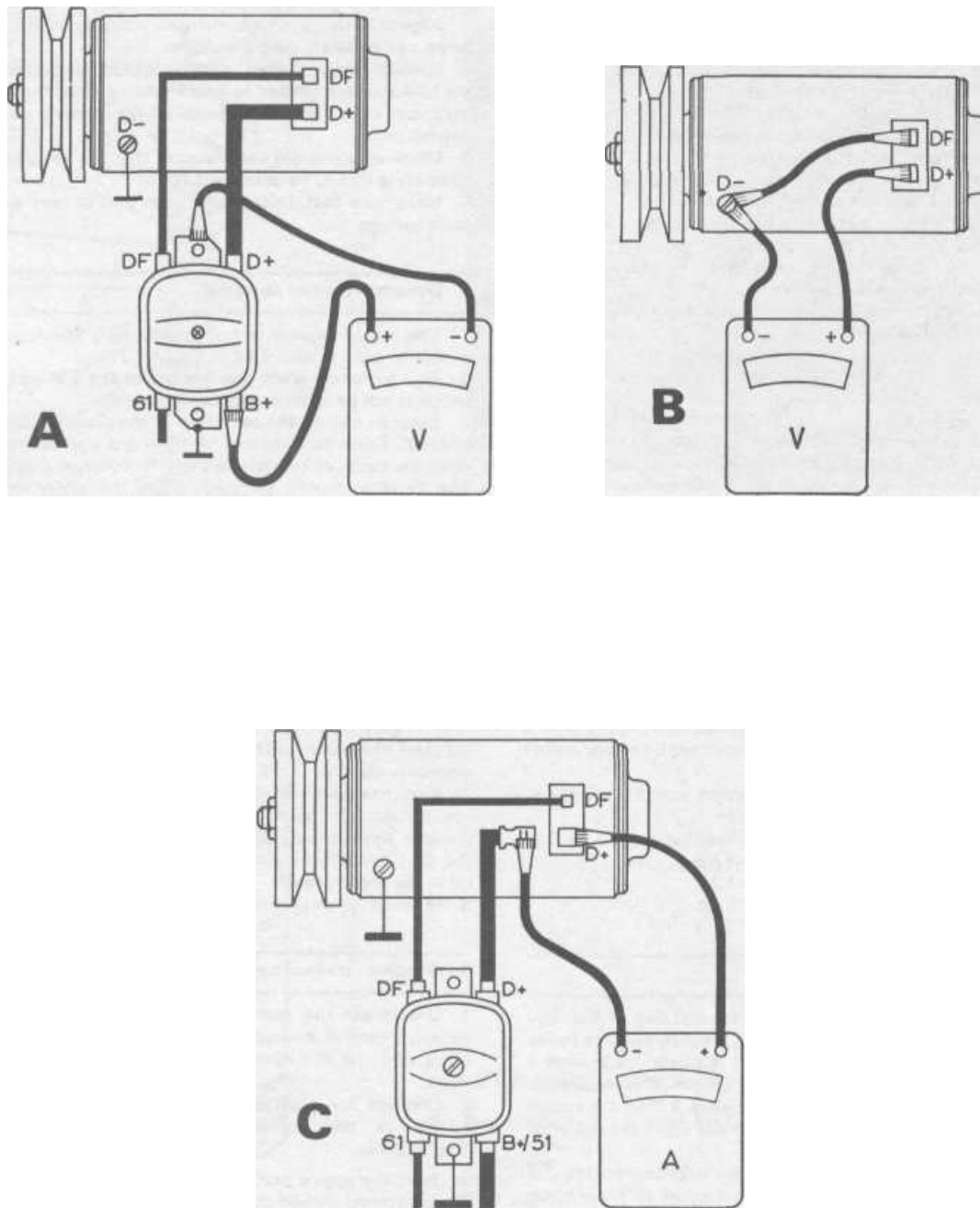
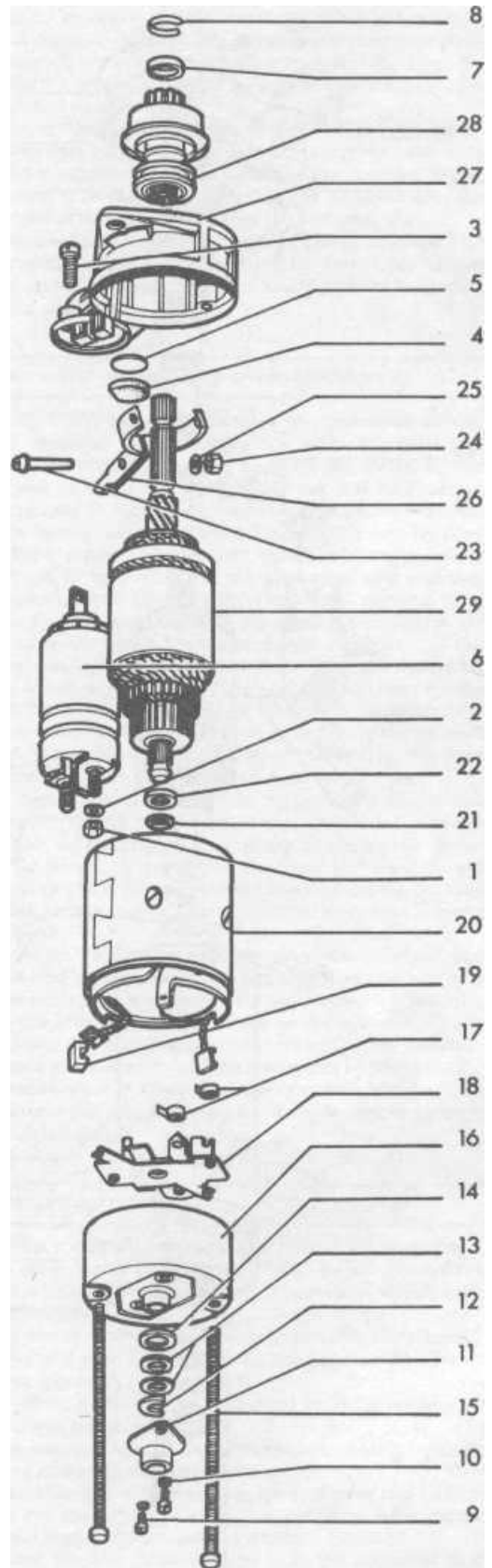


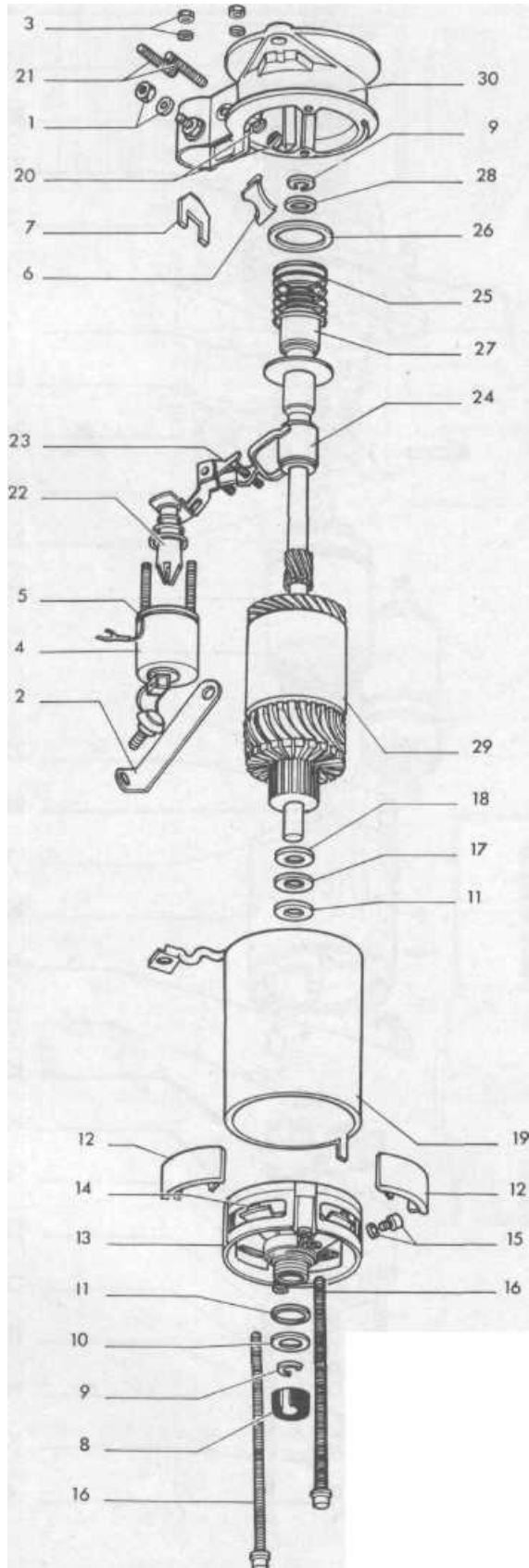
FIG. 9.2 DYNAMO AND REGULATOR TESTS

- A Voltmeter connection for no load regulated voltage check
- B Voltmeter connection for no load unregulated voltage check
- C Ammeter connection for current output check and reverse current check



**FIG. 9.3 STARTER MOTOR COMPONENTS (BOSCH)**

- 1 Nut
- 2 Lock washer
- 3 Screw
- 4 Rubber seal
- 5 Disc
- 6 Solenoid switch
- 7 Stop ring
- 8 Circlip
- 9 Screw
- 10 Washer
- 11 End cap
- 12 C washer
- 13 Shim
- 14 Sealing ring
- 15 Housing screw
- 16 End plate
- 17 Spring
- 18 Brush holder
- 19 Grommet
- 20 Housing
- 21 Insulating washer
- 22 Thrust washer
- 23 Pin
- 24 Nut
- 25 Lock washer
- 26 Operating lever
- 27 Mounting bracket
- 28 Drive pinion
- 29 Armature



**FIG. 9.4 STARTER MOTOR COMPONENTS V.W.**

- 1 Nut and lock washer
- 2 Connecting strip
- 3 Nut and lock washer
- 4 Solenoid housing and winding
- 5 Insulating disc
- 6 Moulded seal
- 7 Insulating plate
- 8 Cap
- 9 Circlip
- 10 Steel washer
- 11 Bronze washer
- 12 Brush inspection cover
- 13 Commutator end plate
- 14 Brush holder and brushes
- 15 Screw and lock washer
- 16 Housing screws
- 17 Dished washer
- 18 Steel washer
- 19 Housing and field windings
- 20 Spring clip
- 21 Pin
- 22 Solenoid cone
- 23 Linkage
- 24 Connecting bush
- 25 Spring
- 26 Intermediate washer
- 27 Drive pinion
- 28 Dished washer
- 29 Armature
- 30 Mounting bracket

the voltage should be approximately 12 volts. At twice this speed the voltage should increase to 36 volts. Check quickly and switch off within a few seconds. If the voltage is nil or low then the generator is faulty.

#### 10 Dynamo - current output check and reverse current check

1 The two previous tests have confirmed the presence or lack of voltage. This does not confirm the presence or lack of amps which are needed to charge the battery (even though the warning light may go out). For the current output check you will need an ammeter - with a range of 50 amps negative and positive. (If you have fitted an ammeter as an extra into the charging circuit already, this, of course, performs the function of this test and in fact tells you at all times whether the generator is doing its job properly).

2 Disconnect the D+ cable from the generator and connect an ammeter in circuit (Fig. 9.2C.) (photo 10.2). Under no circumstances run the engine with the D+ connection out of circuit or the dynamo field windings will be damaged.

3 Start the engine. At low speed the ammeter should show a discharge although at very low idling speed it should move to zero when the regulator cut-out functions. At high engine speed the ammeter should show a positive reading. Try this with some lights switched on to ensure that it maintains a positive charge rate.

4 If the ammeter continues to show a discharge even at low idling speed it means that the cut-out is not functioning and current is flowing back from the battery to the generator.

5 If the cut-out is not functioning the regulator unit must be changed.

#### 11 Regulator - removal and replacement

1 First disconnect the battery. The regulator is held by two screws to the body panel behind the air cleaner in the engine compartment, (photo). Disconnect the cables from the four terminals on the regulator.

2 Replacement is a reversal of this procedure. Note that the thicker of the two wires from the generator is the one that connects to terminal + (D+). It is most important to get these connections correct. Otherwise the generator and regulator could be ruined in the first few seconds of operation.

#### 12 Dynamo - removal, repair and replacement

1 The dynamo is removed in the manner described in Section 4 of Chapter 2. Before deciding to take it out completely make sure that the renewal of the brushes and cleaning the commutator are not the sole things to be done because these can be dealt with without removing the dynamo.

2 If the brushes need renewing remove the end cover. Hook up the ends of the springs which press them into the holders. Then pull the brushes out. Then undo the screw which connects the leads (photos).

3 Whilst the brushes are removed the commutator can be cleaned with a piece of clean cloth soaked in petrol. If the commutator is very scored, changing the carbon brushes may improve things temporarily but the improvement in dynamo output is likely to be small and short lived.

4 When fitting new brushes make sure that they are of the correct type and fit snugly in the holders and slide freely. Brushes which are too loose will clatter about and soon wear out. Those which are tight will probably stick and eventually lose contact with the commutator as they wear away (photo).

5 If any of the brush retaining springs are broken or the commutator is scored the dynamo must be removed for the repairs to be made.

6 To dismantle the dynamo is not a procedure we recommend, principally because there is very little the normal do-it-yourself

man can do to repair it anyway. If the bearings have failed (a very rare occurrence) then the armature will need reconditioning. Skimming the commutator must be done in a lathe. Should the insulation of the armature or field coils have broken down then they will need renewal.

7 Having removed the dynamo and taken off the fan, therefore, we recommend it be replaced with an exchange unit or overhauled by a specialist firm dealing with auto electrics. Make sure when taking it to the repair firm that the regulator goes with it as their tests after rebuild will cover the complete unit.

8 Replacement of the dynamo is described in Chapter 2. Check that the spacer collars behind both the fan and pulley hubs are in position, otherwise when the nuts are tightened they will jam against the end frames.

#### 13 Starter motor - testing, removal and replacement

1 On the Volkswagen the starter is an inaccessible article and short of checking that the mounting bolts are tight and the electrical connections properly made to the solenoid, there is nothing else to be done except take it out if it malfunctions. If the starter fails to kick at all, ascertain that current is being fed from the starter switch to the solenoid. This can be done by connecting a suitably long lead to test each of the terminals on the solenoid in turn. Connect the other end via a voltmeter or bulb to earth. When connected to the smaller terminal (the lead from the ignition switch), there should be an indication on the bulb or voltmeter when the starter switch is operated. If there is not then check the other end of the wire at the starter switch terminal in the same way. If there is no voltage then the fault is not with the starter. Then connect the lead to the larger terminal on the solenoid. If there is no voltage when the starter switch is operated the solenoid is defective. If there is voltage and the starter does not turn, the starter is defective.

2 The starter is held by a bolt at the top and a stud and nut at the bottom. The bolt head is not hexagonal (photo). It is circular with a flat which engages in a recess in the starter mounting flange. To remove it the nut on the other end must be undone and access to this is between the fan housing and the bulkhead in the engine compartment. The nut on the lower stud is accessible under the car.

3 Disconnect the battery and from underneath the car, pull off the small lead at the connection and then undo the nut securing the large cable. All this must be done mainly by feel. Do not confuse the two large terminal nuts on the solenoid. The lower one connects the strap between solenoid and starter (photo).

4 Remove the lower nut and the starter can be lifted out.

5 Replacement is a reversal of the removal procedure. Before fitting, grease the end of the pinion shaft. It runs in a plain bush in the clutch housing.

#### 14 Starter motor - repair

1 The first stage of dismantling is to remove the end cover plate so as to get access to the brushes. If these do not protrude above the tops of their holders renewal is necessary, which calls for further dismantling.

2 Undo the nut connecting the strap between the solenoid and the starter and then the two screws holding the solenoid to the end frame (photos).

3 The solenoid can now be unhooked from the operating lever inside the end frame, (photo)

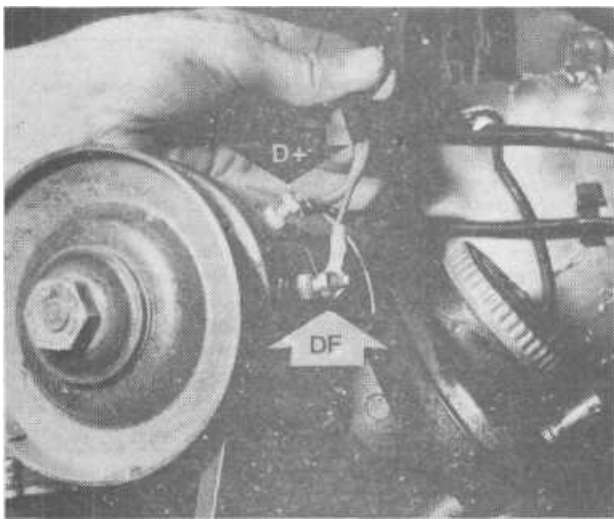
4 If the solenoid only is faulty this is as far as it is necessary to go. A new solenoid unit can be fitted now.

5 Remove the two screws holding the end cover cap (photo).

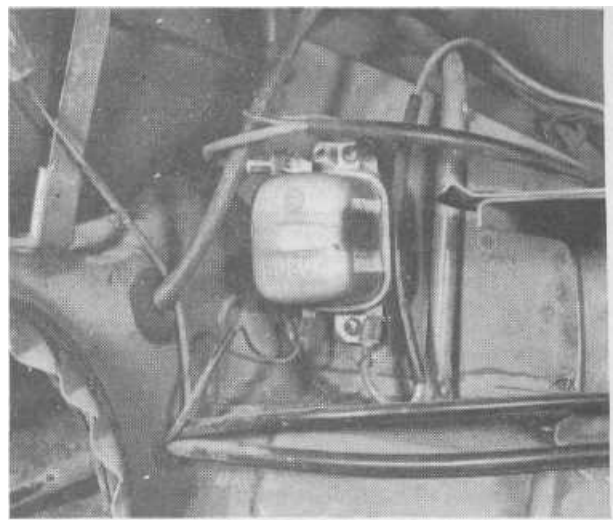
6 Slide out the 'U' clip and remove the shims from the end of the shaft. These shims control the endfloat (photos).

7 Remove the two through bolts from the end cover and the end cover may then be taken off giving access to the commutator brushes (photos).

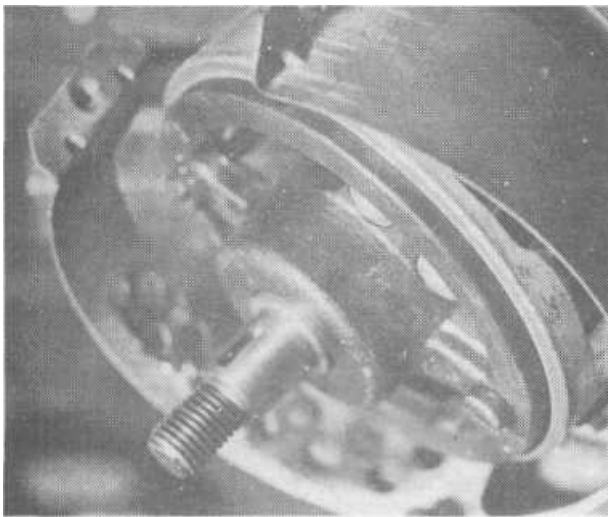
8 Hook up the springs holding the carbon brushes in the



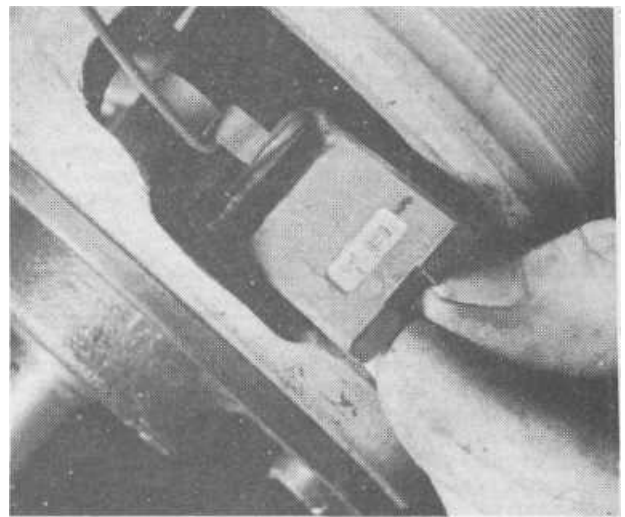
10.2 Terminals D+and DF on the generator



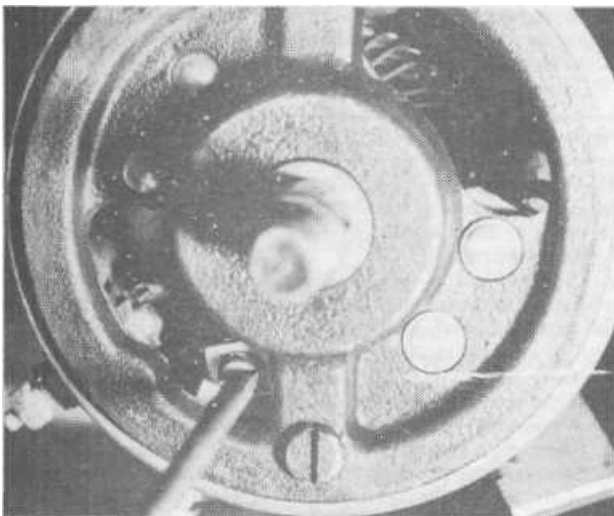
11.1 The regulator is behind the air cleaner in the engine compartment



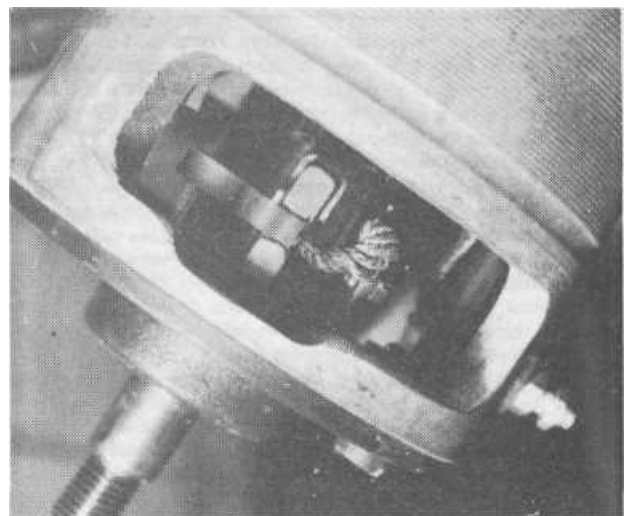
12.2a Removing the aperture cover from the dynamo



12.2b Hooking up spring to pull the brush from the holder

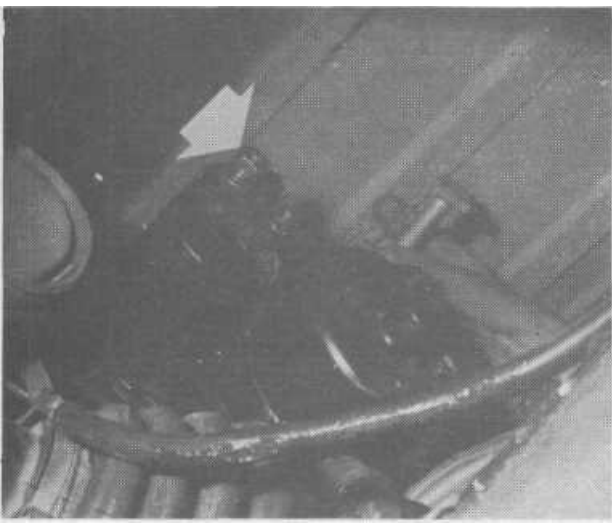


1 2.2c Undo the brush terminal tag screw

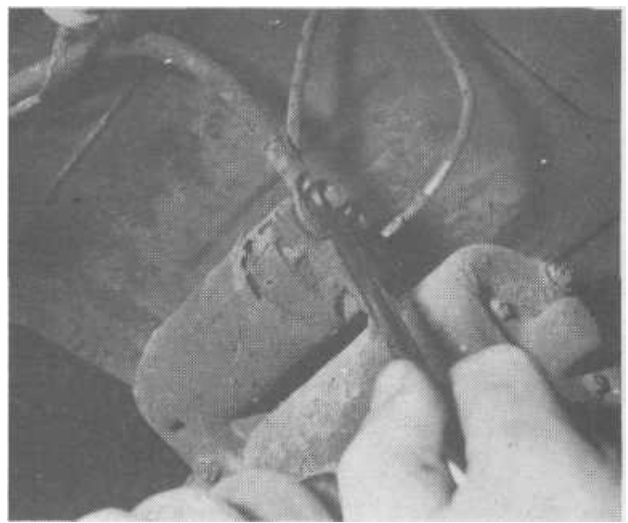


12.4 Brush and spring correctly fitted in position





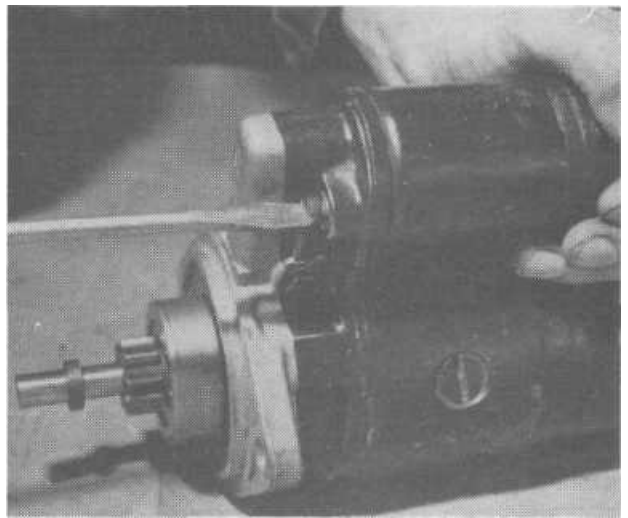
13.2 Removing the starter top bolt. Note the bolt head and terminal (arrowed) for the main cable connection



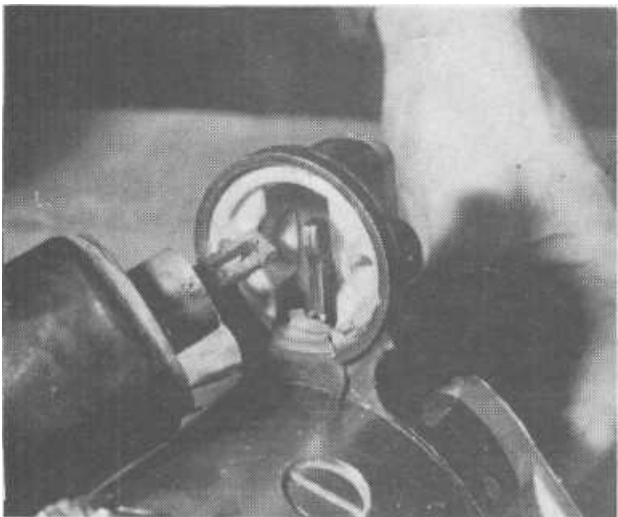
13.3 Do not confuse the two nuts on the solenoid



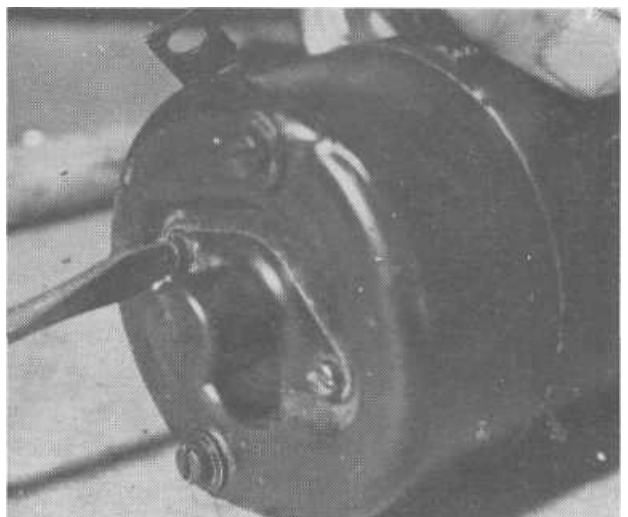
14.2a Undoing the connecting strap terminal nut



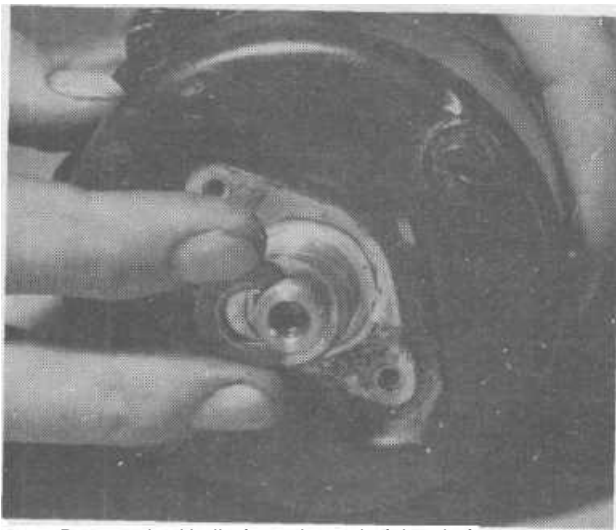
14.2b Removing the solenoid retaining screws



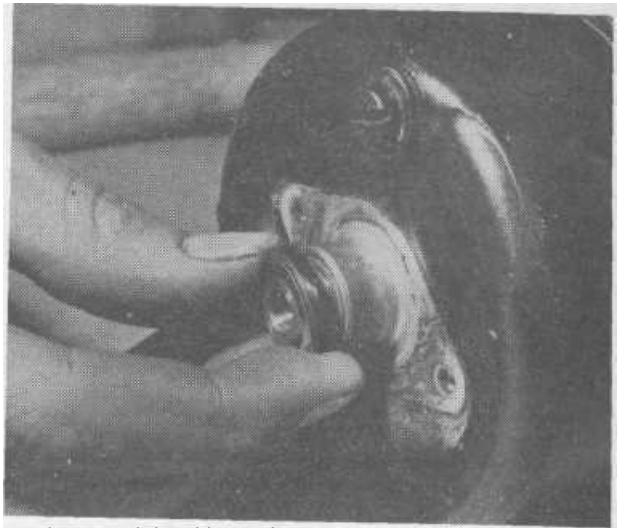
14.3 Unhook the solenoid from the operating lever



14.5 Remove the end cover cap screws



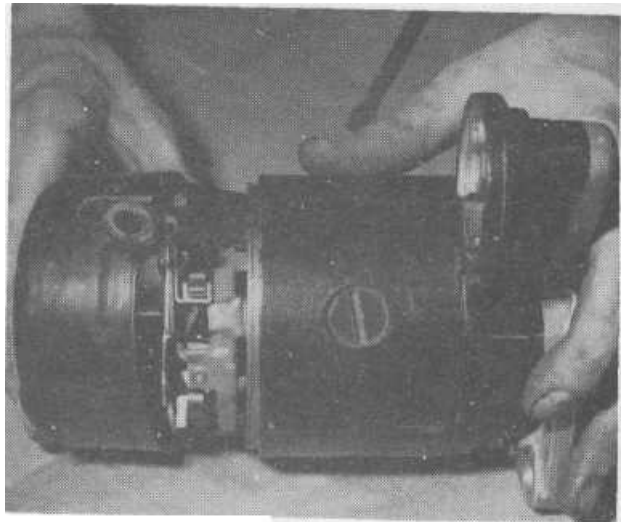
14.6a Remove the U clip from the end of the shaft



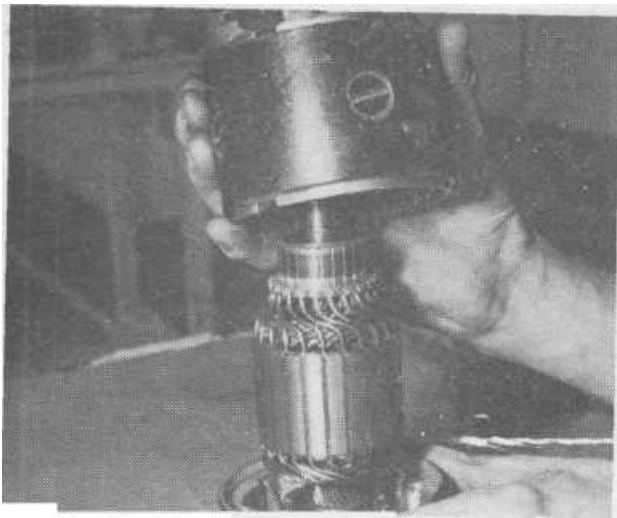
14.6b. . . .and the shim washers



14.7a Remove the through bolts



14.7b Take off the end cover



14.8 Lift the yoke and brush holder assembly off the armature



14.1 2 Refit the yoke so that the tongue and cut out fit together

holders and push them to one side so that the pressure is relieved. The yoke complete with the brush holder mounting plate may then be drawn off the armature. Watch out for the washers on the end of the shaft (photo).

9 To renew the brushes, two may be detached by simply removing the screws whilst the other two need to be cut off and new ones soldered to the braided leads. Leave sufficient length to solder the new ones onto easily.

10 To remove the end frame from the drive end of the shaft first push back the stop ring with a suitable tube so that the jump ring underneath can be released from its groove. The end cover assembly complete with pinion may then be drawn off.

11 The pinion drive should turn one-way only inside the clutch easily. If it does not the whole unit needs renewing. The pinion teeth should not be badly worn or chipped. The yoke of the pinion operating lever should be a good fit in the groove of the pinion sleeve.

12 Reassembly is a reversal of the dismantling procedure. Thoroughly grease the moving parts of the pinion operating lever first. When replacing the yoke engage the cut-out and tongue correctly (photo).

13 The carbon brushes should all be held up in their holders and this can be achieved if the springs are jammed against the sides of the brushes. The armature has two washers on the end and these must be fitted so that the thrust washer goes on first and the insulating washer after that.

14 When the pinion stop ring is refitted stake it into position over the jump ring after the latter has been fitted in its groove.

15 When refitting the solenoid ensure the plunger hooked end is securely placed over the operating lever.

16 The screw heads and joint faces of the commutator end cover, the solenoid and end frame should all be treated with sealing compound to keep water out. Use the Volkswagen product specially prepared for this if possible. It is important that it is not applied too thickly, otherwise clearance distances may be upset. If, after reassembly, the endfloat of the shaft exceeds 0.012 inch it should be reduced by adding shim washers under the U retaining clip on the end of the armature shaft under the small cover.

17 Because the pinion end bearing (bush) is located in the clutch housing, it is not possible to rotate the starter under load or at speed when not fitted to the engine. The customary bench tests are therefore not applicable to this starter.

## 15 Fuses and relays

1 The fuses are located under the dash panel, (photo) If any fuse should blow it is normally due to a short in the circuit concerned. With the aid of the wiring diagram, therefore, first check visually at all the points in the circuit where such a fault is most likely to occur. Likely places are where wires pass through individual holes into lamp units or through holes in the body-work where grommets have been disturbed. In the ignition circuit check the connections at the coil and choke. Feel switches to see if they are hot, which they should not be.

2 If no obvious solutions occur disconnect all items on the particular circuit (e.g. the parking light bulbs if that is the circuit concerned). Fit another fuse of the proper rating. Then reconnect one item at a time, switching on each time until the fuse blows again. This will isolate the faulty part of the circuit and a closer examination can be made in that area. If you choose to fit a fuse of a much higher rating to try and overcome persistent blowing, the least that can happen is that the wiring will burn out somewhere. The worst result could be a fire.

3 Relays are in effect remote switches which avoid having to carry the full operating current of the apparatus through the actual operating switch (a starter solenoid is a relay). The fuse rack incorporates a relay console as well so that they may be simply plugged into it for renewal or additional wiring requirements. There are normally at least two relays fitted, one a combined relay for lights, flashers, horn etc, and another for the turn signal/emergency flasher circuit. Relays should be checked

by substitution of a servicable unit where malfunction of a circuit covered by them occurs.

4 On pre-August 1969 models which are fitted with an emergency flasher system the relay is not mounted on the fuse rack but separately on top of the upper steering column support bracket. It is best to remove the dash panel when making connections to it so that the wires may be seen easily.

5 If additional electrical accessories are to be connected to the fuse block, it is easier to make a neat job if the fuse rack is first detached in the following way.

6 Remove the glovebox or parcels shelf to expose the fuse rack securing screws and the retaining clip.

7 Release the clip and pull the fuse rack straight up out of its holder. The screws and wiring harness clip may be released if necessary to provide even more working access.

## 16 Direction indicators - fault tracing and repair

1 One of the most usual causes of failure is due simply to bad connections to earth. This can occur at the bulb holders (usual) or the terminal connections. If, therefore, the flashers can be heard but do not light - or only operate slowly - check all the bulbs, holders and screws for signs of whitish corrosion deposits (which may have been caused by seepage of water past the lamp housing seals). Check also the appropriate fuse.

2 First check that the flasher relay itself is not faulty. The simplest way to do this is by substitution with a new one. The relay is located on the fuse rack under the dash panel or in pre-August 1969 models on the steering column support bracket.

3 If the fault is in the switch itself the steering wheel must be taken off (Chapter 11) so that the switch may be removed. This combined switch if faulty must be renewed as a unit (photo).

## 17 Windscreen wipers - fault finding

1 If the wipers do not work when they are switched on, first check the fuse. If this is sound then there is either an open circuit in the wiring or switch, the wiper motor is faulty, or the pivot spindles or linkages may be binding.

2 If the wipers work intermittently then suspect a short circuit in the motor or a poor contact to earth. The earth is connected at the main mounting screw. Alternatively, the armature shaft endfloat adjustment may be too tight or the wiper linkage may be binding.

3 Should the wipers not stop when they are turned off there must be a short circuit in the switch or wiring.

4 Do not run the wipers with the blades on a dry screen when testing. Excessive friction overloads the motor.

## 18 Windscreen wiper mechanism - removal and replacement

1 Disconnect the battery earth lead.

2 Slacken the clamping screw on the wiper arm brackets and pull the arms off the spindles.

3 Remove the hexagon nut, washers and seals from around the spindles.

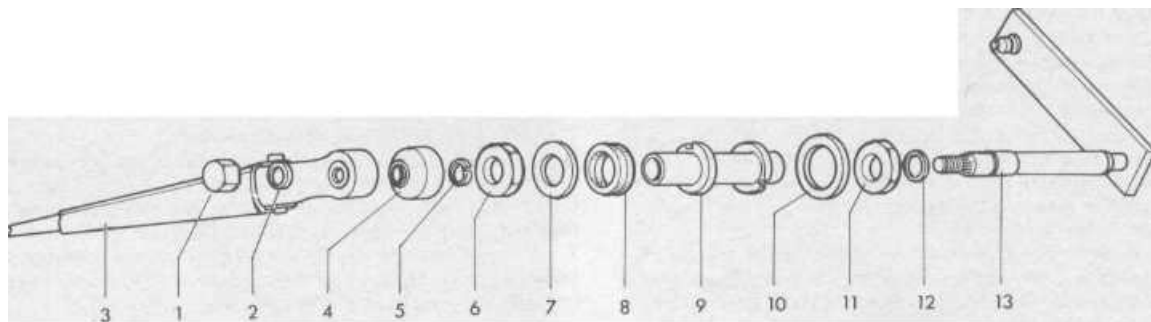
4 Remove the heater branch connections under the instrument panel.

5 Disconnect the cables from the motor.

6 Undo the screw which holds the motor and frame to the mounting bracket. The motor and the linkage can then be removed together.

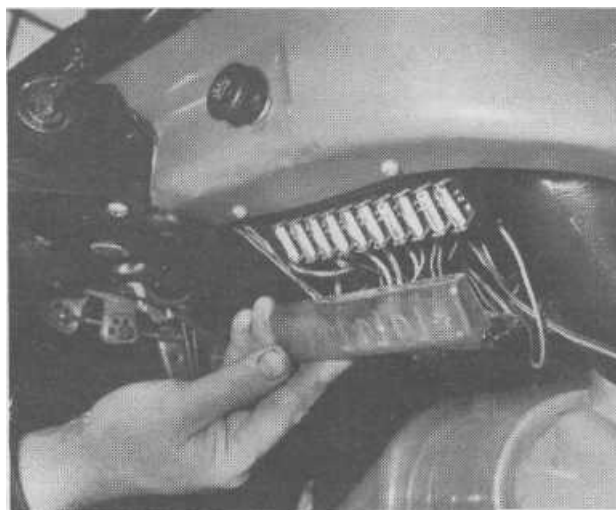
7 To separate the motor from the wiper mechanism first mark its position in relation to the frame. Then pry the ball joint connections apart with a screwdriver and undo the securing screws.

8 Replacement of the motor and wiper mechanism is a reversal

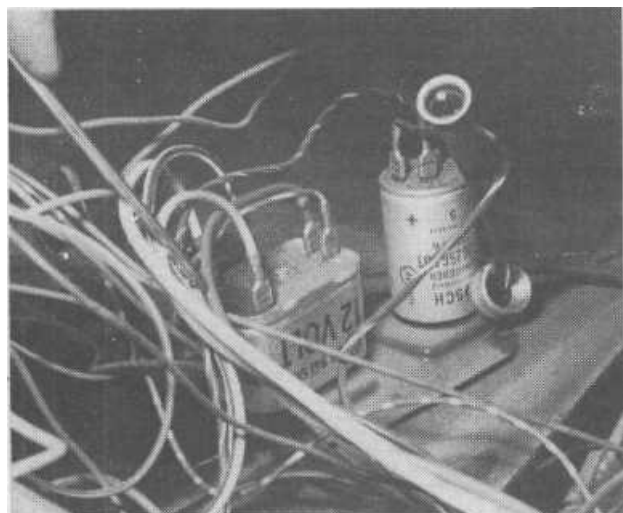


**FIG. 9.5 WINDSCREEN WIPER SPINDLE AND BEARING ASSEMBLY**

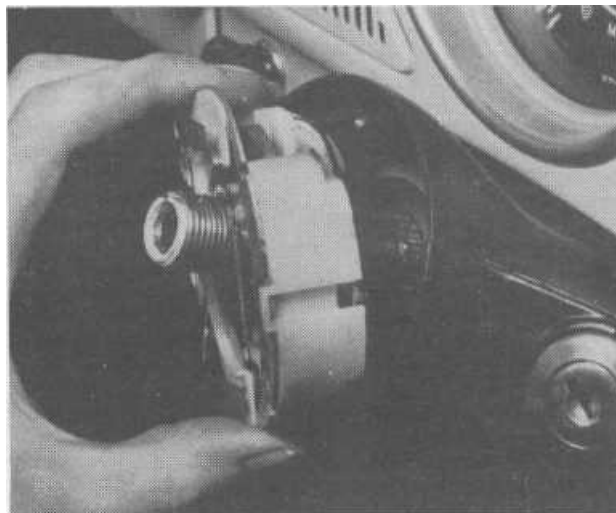
- |   |                  |
|---|------------------|
| 7 Cap nut (early models had clamp nuts) | 7 Washer         |
| 2 Lock washer                           | 8 Seal           |
| 3 Wiper arm                             | 9 Shaft bearing  |
| 4 Bearing cover                         | 10 Spring washer |
| 5 Circlip                               | 11 Brass nut     |
| 6 Nut                                   | 12 Spring washer |
|   | 13 Wiper shaft   |



15.1 The fuse box is located under the dash panel.



15.4 Pre August 1969 the relays are on the top of the steering column support bracket



16.3 Removing the direction indicator switch

of the removal procedure. When refitting the unit to the car make sure the spindles are at right angles to the windscreen. The mounting hole in the frame is slotted to permit adjustment. The earthing strip contact at the mounting screw should be clean.

9 The sealing washers around the spindles must be correctly positioned and care taken not to overtighten the clamping screw the correct torque being 2–3 lb/ft. (30–40 cm kg).

### 19 Windscreen wiper motor - repair

1 Other than for renewal of the carbon brushes, dismantling for further repair is not economical.

2 To renew the carbon brushes the wiper motor and frame assembly must be removed from the car as described in the previous sections and the motor separated from the frame.

3 Remove the armature end cover by undoing the clip.

4 Renewal of the brushes means renewing the complete brush plate assembly unit.

5 The contacts for the self parking switch should be clean and have a gap setting of 0.8 mm/0.032 inch.

6 The brush holders are held in tension against the commutator by a common spring. Unhook this and swing the holders outwards. The old brushes can be removed with a pair of fine nosed pliers. The new ones should be a tight fit in the holders and should seat squarely onto the commutator when the holder is moved back into position.

7 On motors fitted with a self-parking device check that the points gap is 0.8 mm (0.032 inch) and that the points are clean.

### 20 Windscreen wiper spindle bearings - renewal

1 One of the causes of jamming could be due to wear in the spindle bearings and these can be renewed after the assembly has been removed from the car.

2 Having disconnected the driving link and connecting rod by means of removing the spring clips and washer, take off the seal and washer and undo the locknut securing the bearings to the frame.

3 Replace any of the smaller nylon bushes that may be worn also.

### 21 Windscreen wiper switch and washer valve - removal and replacement

1 The combined wiper switch and washer valve can be easily removed after first disconnecting the battery earth cable and unscrewing the knob from the switch.

2 Then, from behind the panel, pull off the wires and washer pipes. Unscrew the retaining ring and take off the switch.

### 22 Windscreen washer

1 The washer is operated by a valve incorporated in the wiper switch. The water reservoir tank is mounted on the front panel in the drivers compartment and a detachable cover gives access to the filler cap and pressure hose. The container is filled and then pressurized from an ordinary air pump to 42 p.s.i.

When the wiper switch button is depressed the valve opens and fluid under pressure passes through the jets onto the screen.

2 If no water issues from the jets, first check that all pipes are connected and intact and that the reservoir is pressurised correctly.

3 Then check that the nozzles of the jets are clear. Use a piece of fine wire to poke them out if necessary.

4 If it becomes obvious that the switch/valve is not working, then it must be renewed.

### 23 Stop lamps and dual brake circuit warning lamp

1 The stop lamps are operated by either one of two hydraulic switches. These are fitted into the four way distribution union mounted just above the master cylinder (photo).

2 If, after checking that the bulbs, fuse, and connections are in

order, the brake lights still do not work (with the ignition switched on) pull off the leads from each hydraulic switch in turn and touch them together. If the stop lights now work the switch is at fault and must be renewed.

If there are three leads to each switch the two to connect are those to terminals 81 and 82a (the two side ones).

If a switch is removed for any reason it will be necessary to bleed the braking system at all four wheels.

3 If the stop lights still do not work when the terminals of the switch are bridged then the fault lies in the wiring circuit. Check that voltage is coming to the switch and carry on from there tracing back with the aid of the wiring diagram.

4 As mentioned in Chapter 9 some models are fitted with a pressure differential piston in the master cylinder which operates a single switch plunger and warning lamp.

Other versions use special brake light switches instead and these are identifiable by having three terminals each. Inside each switch is a two way contact. Should either one of the switch contacts not move due to inadequate fluid pressure the current from terminal 81 (see diagram) on the other operative switch will feed through terminal 81a on the non-operative switch and light up the warning lamp. The warning lamp also has a direct feed from the ignition circuit which enables the bulb to be tested by depressing the face of the lamp housing.

In the rare circumstances of pressure failing on both circuits, neither the brake nor warning lights will operate; but this will be the least of your problems!

### 24 Horn

1 The horn is mounted on a bracket under the front of the vehicle. It is fed by the ignition circuit but is separately fused. The circuit is completed when the horn button is pressed.

2 If the horn fails to work first check that current is reaching the horn when the ignition is switched on. If this is O.K. check that there is continuity from the end of the horn earth wire to earth when the wire is detached from the horn and the button is pressed. This is the most usual area for faults to occur. The button contact surfaces themselves can be checked by levering the central cap out of the steering wheel with a screwdriver (photo).

3 The earth return wire goes via the bottom of the steering column where there is an insulated connection and tag attached to the bottom of the column tube. To get at this involves removing the steering wheel and column tube as described in Chapter 10. The column tube acts as part of the earth circuit for the horn and must therefore be effectively insulated from the bodywork and the steering shaft.

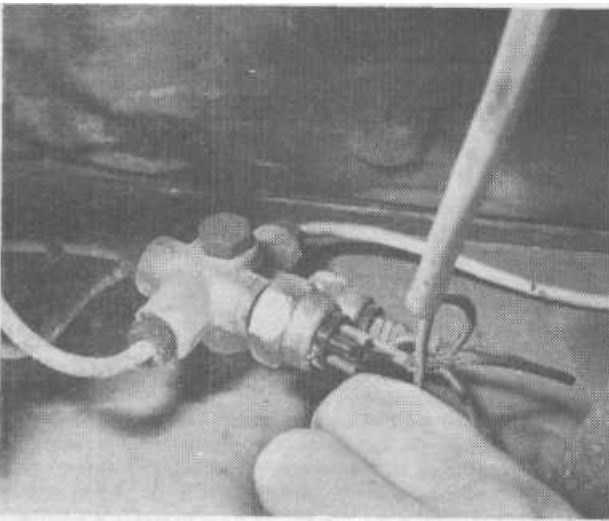
4 If the horn does not function correctly make sure that the connections are all clean and tight and that the body of the horn is not touching any of the nearby bodywork.

5 If, by a process of elimination, it is found that the horn itself is faulty, some results may be achieved by turning the adjusting screw in the back (photo). This however is a last resort as it will alter the contact points setting inside. Indiscriminate movement of the adjusting screw may ruin the horn completely.

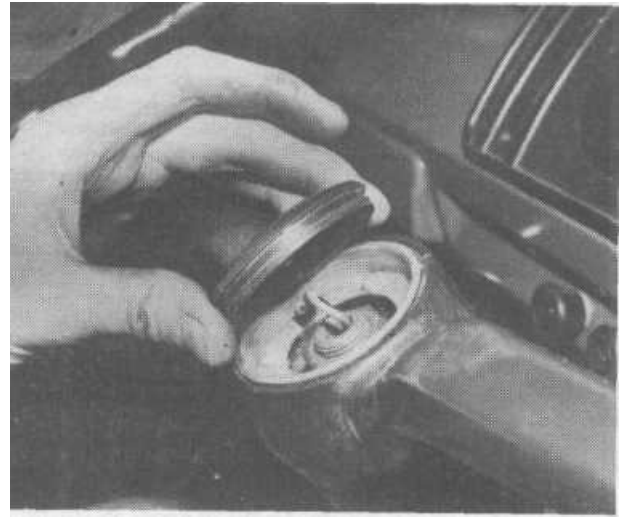
### 25 Headlamps, side lamps, rear lamps, bulbs and adjustment

1 Rear lamp bulbs are accessible after removing the lenses. These are held by two screws on the outside (photo). The same goes for the front side lamps (photo). With the lenses removed the bulbs can be extracted by pressing them in firmly and turning them anticlockwise and releasing.

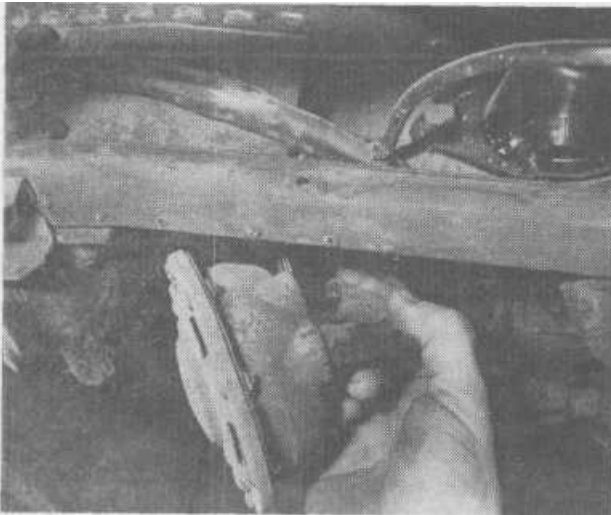
2 Depending on the regulations of the country the front parking lamps are incorporated with the turn signal as a double filament bulb or in the headlamp as a separate small bulb which is fitted on the main lamp holder and shines through a clear patch in the reflector (photo). On later models, a waterproof type side lamp bulb holder is used incorporating a two pin connector plug. It is important with this type of holder that the



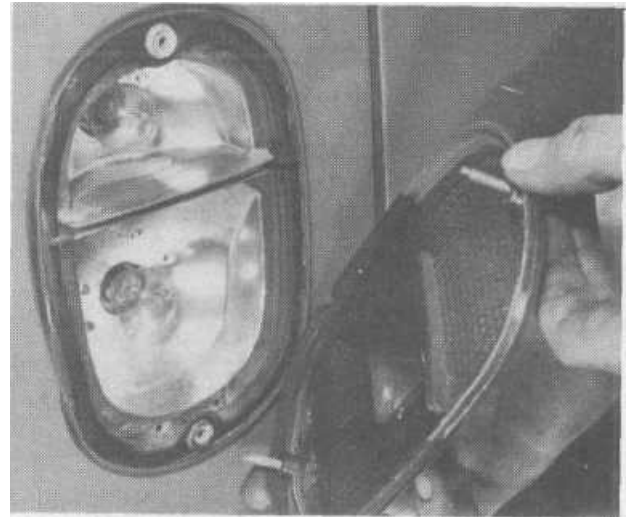
23.1 The stop light switch is connected to the four way distributor just over the master cylinder



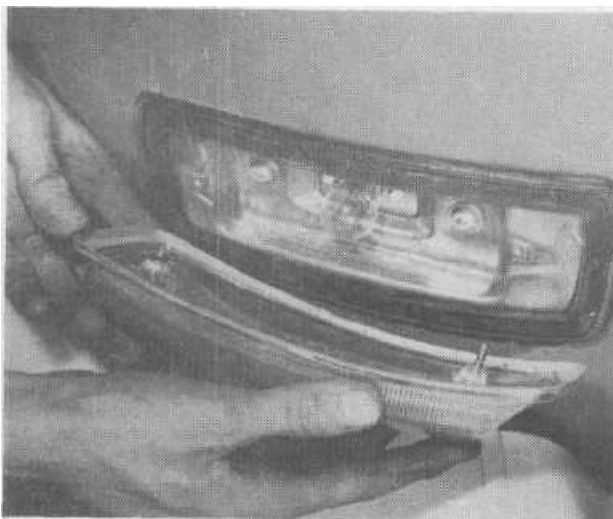
24.2 Prise out the cap from the centre of the steering wheel



24.5 As a last resort try moving the adjusting screw



25.1a Two screws to remove the rear lamp lens

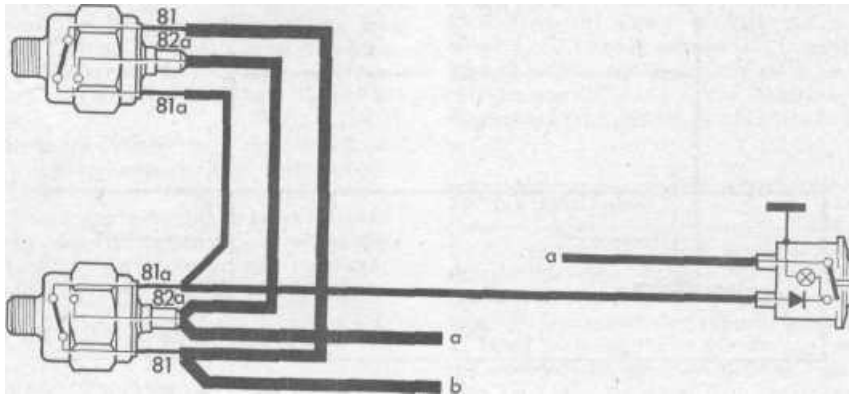


25.1 b Two screws to remove the front side lamps



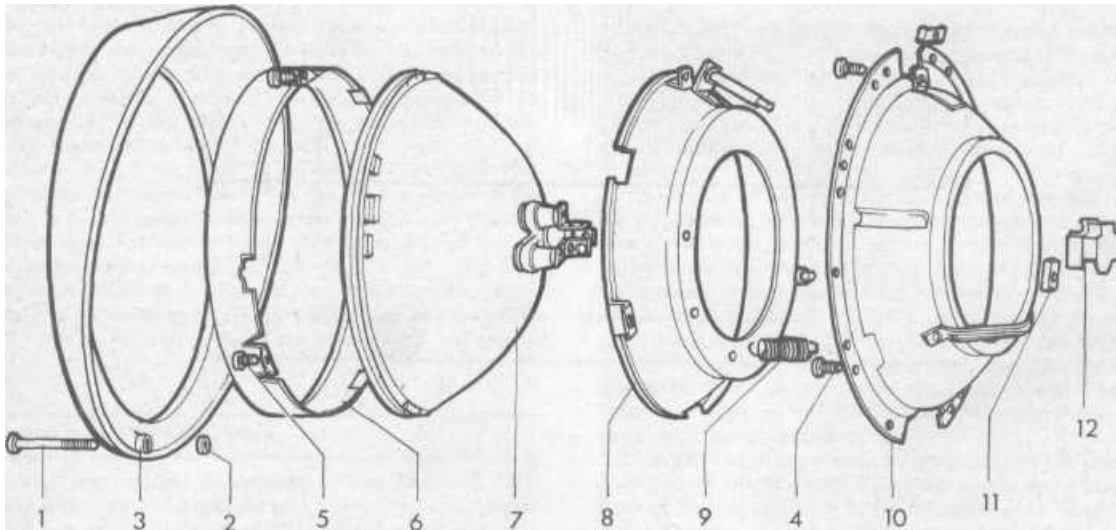
25.2 On some models the parking lamp is in the head light reflector





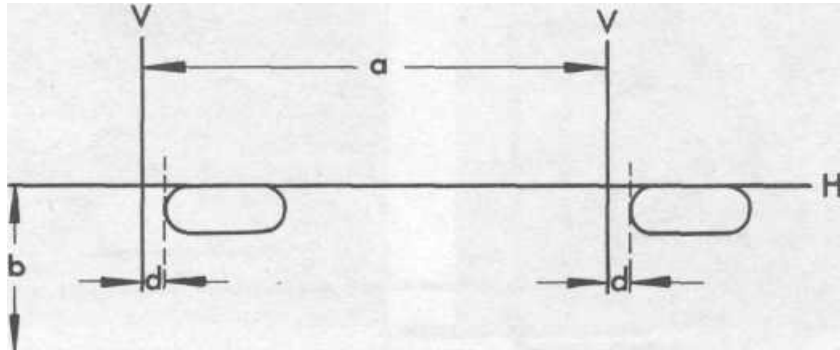
**FIG. 9.6 BRAKE LIGHT/BRAKE PRESSURE WARNING SWITCHES. CIRCUIT DIAGRAM (SEC. 23)**

- a. *current feed to brake lights*
- b. *current feed to brake pressure warning switches*



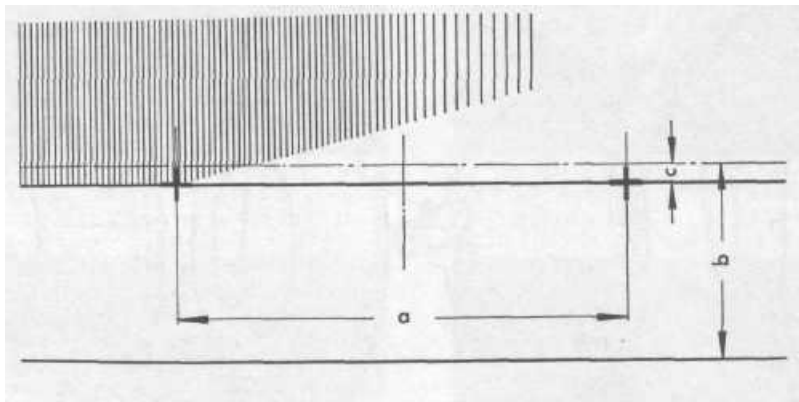
**FIG. 9.7 SEALED BEAM HEADLAMPS - COMPONENTS (SEC. 25)**

- |                      |                        |                                    |                   |
|----------------------|------------------------|------------------------------------|-------------------|
| 1 Rim securing screw | 4 Securing ring screw  | 7 Sealed beam unit                 | 10 Securing ring  |
| 2 Rubber washer      | 5 Retaining ring screw | 8 Aiming ring with 2 aiming screws | 11 Tapped plates  |
| 3 Rim                | 6 Retaining ring       | 9 Retaining ring spring            | 12 Terminal block |



**FIG. 9.8 HEADLAMP BEAM AIMING DIMENSIONS SEALED BEAM UNITS. RIGHT SIDE DIP**

- A Distance between lamp centres (1080 mm/42.5 in)
- B Height of lamp centre above ground (measure on vehicle)
- D 2.0 ins/50 mm
- H Lamp horizontal centre line
- V Lamp vertical centre lines



**FIG. 9.9 HEADLAMP BEAM AIMING DIMENSIONS, REPLACEABLE BULBS, RIGHT SIDE DIP**

- A Distance between lamp centres (1080 mm/42.5 in)
- B Height of lamp centre above ground (measure on vehicle)
- C Dip angle height (1%) for distance i.e. 50 mm/2 ins.
- N.B. Mirror diagram for left dip

plug is connected the correct way round — grey wire positive.

3 All double filament bulbs fit only one way round because the wattage of each filament is different - the flasher filament being brighter. For this reason the bayonet pins are offset. See that you get them the right way round on replacement.

4 To remove the headlamp unit from the vehicle unscrew the lowest screw which secures the rim. Do not confuse this with either of the two beam aiming screws. Lift up the lower edge of the rim to unhook the top edge and then pull the whole lot out.

5 To remove the bulb undo the bulb holder from the back of the reflector by turning it anticlockwise and then pull the bulb and connection apart (photo).

6 When fitting the new bulb try to remember to avoid handling the glass with the fingers which will leave a deposit which can eventually cause discolouration. Fit the bulb and connector together and then fit the holder into the reflector so that the lugs and notches line up.

7 Should the headlamp lens need renewal proceed as described in paragraphs 4 and 5.

8 It will then be necessary to remove the adjusting screws; so if these are very rusty, clean them properly first.

9 The reflector is held into the rim with spring clips.

10 When fitting a new glass the same type must be used and the sealing ring should be in perfect condition. Make sure the glass is fitted the correct way up.

11 Replace the spring clips and put the adjusting screws back.

12 On sealed beam lamps the bulb and reflector are a single unit and can be identified by the absence of a bulb holder. The wire connection fits straight onto the three terminals at the back of the unit. This item is removed and replaced in the same way that would be used for releasing the reflector and glass on a conventional model.

13 Headlamp alignment is a task which can only be done properly with optical alignment equipment. However, a rough setting can be made until the time when the beams can be properly set.

14 The accompanying diagrams show the setting dimensions for lamps with replaceable bulbs and sealed beam units for vehicles with lamps which dip to the right (ie drive on the right of the road). For vehicles which drive on the left and dip to the left both diagrams should be mirrored. The adjusting screws for the vertical adjustment of the beams are at the top of the rim and those for the lateral adjustment at the side.

15 The vehicle should be standing on level ground with tyre pressures correct and the equivalent of the drivers weight in the driving seat. It should face a vertical *screen which should be 16.4 ft (5 metres) away for conventional bulb units and 25 ft (7.6 metres) away for sealed beam units.*

16 The vehicle should be settled on the suspension by rolling backwards and forwards and each light should be checked with the other covered up. All settings are made with the beams dipped.

## 26 Instrument panel and instruments

1 Disconnect the battery if removal is contemplated. The instruments are housed in a console which is held to the dash by four screws (photo). Before the console can be lifted away the four ventilation and heating control levers have to be taken off and this is described in Chapter 2. It is not simply a matter of pulling the blue and red knobs off. They do not come off. The lever itself is fixed inside.

2 With the four levers removed and the screws taken out lift the console out a little way and detach the speedometer cable. This is done by screwing off the cable union (photo). Hold the union near the end with a piece of adhesive tape.

3 Instruments may be removed from the console once the electrical connections have been removed from their terminals (photo). If there is any question of doubt about being able to replace the wires to their correct terminals mark them with tape or coloured tags before pulling them all off.

## 27 Steering column - Ignition/starter switch

1 To remove the switch first disconnect the battery and then detach the cables leading to the switch behind the dash.

2 Remove the screws holding the switch and then those securing the steering column tube support plate. Then turn the housing to the right until the small grub screw in the switch cylinder can be undone. The switch may then be drawn out. Replacement is a reversal of this procedure.

## 28 Turn signal switch

1 To remove the switch first disconnect the battery. Then remove the screws holding the switch housing to the column followed by the screws holding the switch to the switch housing (photos). Disconnect the cables to take the switch off.

2 When replacing the switch the gap between the housing and the underside of the steering wheel hub must be 2 mm (.080 ins).

## 29 Computer diagnosis

Volkswagen has developed a maintenance check system linked into a recording and measuring apparatus.

The main purpose of the system is to reduce the human error, primarily one of omission, in the check list for their 6000 mile service.

A standard print-out sheet to cover all models lists 88 separate checks. 65 of these checks apply to all models.

It must be emphasised that the scheme is purely a diagnosis and that apart from ensuring that the tyre pressures are correct to start with (so that headlamp alignment may be measured correctly) the diagnosis service man does not do any rectification work.

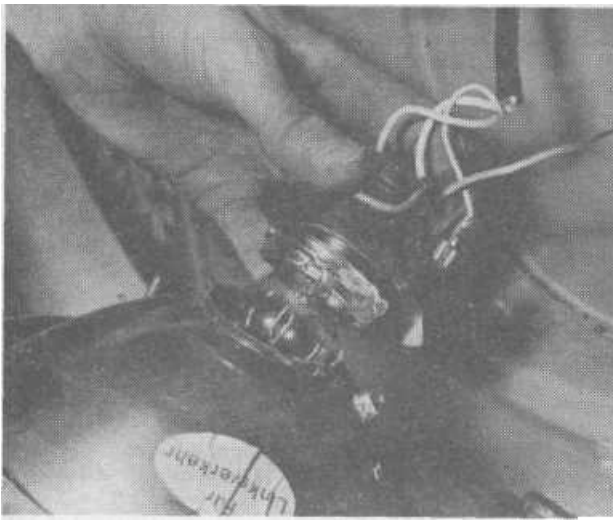
All models from August 1971 onwards (1972 model year) are fitted with a central multipin socket which is wired to all the necessary points for the computer which is plugged into it. For models prior to that time back as far as about 1966 (depending on the model in question) the diagnosis equipment can be hooked up on a special cable fitted with crocodile clips attached to the strategic terminals.

The model of vehicle is first determined together with any of the standard options fitted. Since the introduction of the plug-in socket *every car carries* a sticker in the engine compartment showing its computer diagnosis code number. This number corresponds with a plastic card measuring about 1.2 x 6 inches which is punched full of holes corresponding to the specifications for that particular car. This card is fed into the computer. From then on everything measured on the vehicle is compared with the norm on the punch card. The print-out indicates + (OK) or — (not OK) for those operations where the checking is done automatically.

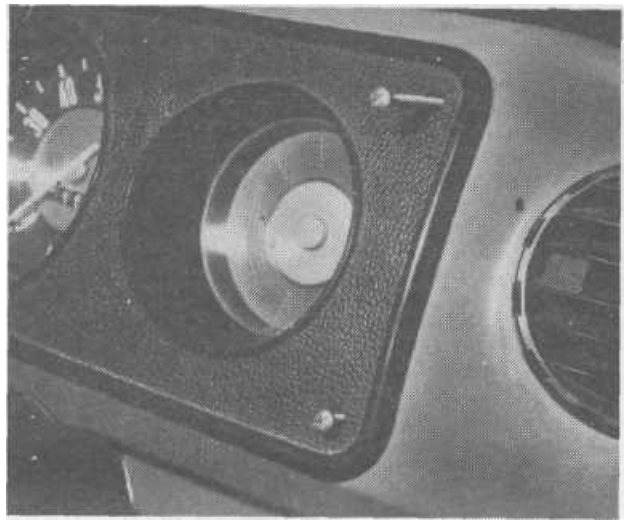
The technician has a hand set connected to the computer and a window in this hand set shows each check requirement. At the time of writing only 24 of the 88 items are checked automatically. The rest are checked by the technician and where all is well he presses a button on the hand set marked '+'. If not applicable there is another button and if unsatisfactory a third button marked '—'. When any of these is pressed the mark is noted on the print-out sheet and the window in the hand set moves forward to the next item for checking.

The items which are measured by the equipment automatically are the steering geometry, ignition and charging systems and cylinder compression. Lights and battery conditions are checked automatically only on those models fitted with the connection socket.

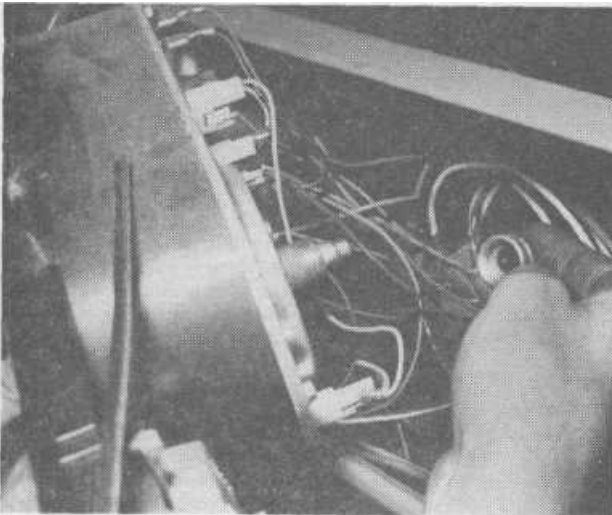
The steering geometry is checked by photo electric beams and mirrors as the steering wheel is turned through 180°, 90° each side of the straight ahead position. This is done within a 20



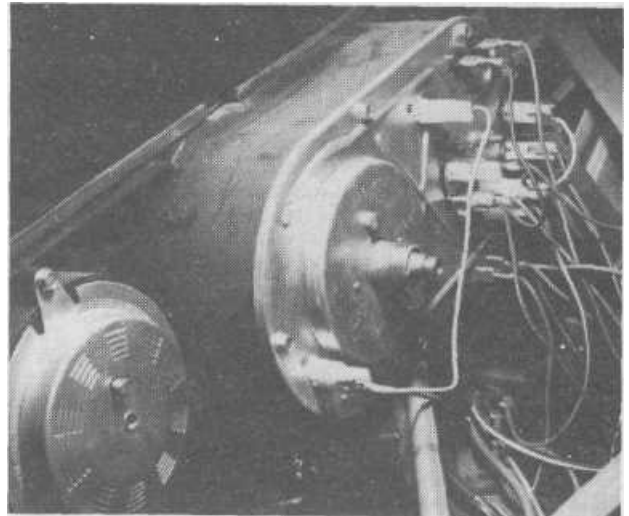
25.5 Turn the bulb holder anti-clockwise and take it out



26.1 Four screws hold the instrument panel



26.2 Ease the panel forward and disconnect the speedo cable



26.3 The connections at the rear of the panel



28.1a Undo the screws holding the switch to the column (Note steering wheel has been removed to give a better photo)



28.1b Disconnect the cables to take the switch off

second period and measures toe and camber and prints out the answer in degrees and minutes. The ignition and charging systems are measured by the resistances of the various circuits. It is important that all connections are clean and that cable sizes are standard.

The cylinder compression is measured by calculating the load on the starter motor when the engine is turned over. The state of the battery and the temperature of the engine oil is measured and taken into account for this check.

There is no doubt that the system is quick, accurate and calculated to tell the unhappy customer all the awful things wrong with his vehicle in the shortest possible time. However, it is gratifying to be able to record that like all computer systems it is dependent on the information it is given and in this case the information is based on the experience and conscientiousness of the technician in control.

As far as the car owner is concerned there are a few words of warning to be given. The diagnosis can only be carried out accurately (as far as the automatic side of it is concerned) when the vehicle being processed conforms exactly to the types and options of the computer card which sets the standard. Additions and modifications in the electrical system can upset the measured resistances. Damage to the wiring system, or unusual resistances caused by faulty connections, corrosion or deteriorated insulation can also affect readings. It is perhaps for this

reason that the automatic diagnosis is as yet not very extensive, depending as it does on electrical measurement within the vehicle circuitry.

To sum up therefore, it can be seen that the computer diagnosis system has the following positive advantages as part of any routine maintenance programme.

- 1 A complete check list which follows a logical sequence in the shortest possible time — thus saving time and money.
- 2 A great reduction in the possibility of human error by omission.
- 3 A printed record of the decision made on each and every check by the diagnosis technician.
- 4 Provided the record is kept regularly the car's value is maintained at a much higher level than otherwise.
- 5 But the system is still only as good as the personnel using it.

### 30 Wiring diagrams

Due to the number of wiring diagrams produced by VW for the 1600 Transporter, it is not practical to include them all. Therefore, the diagrams included are a representative selection only.

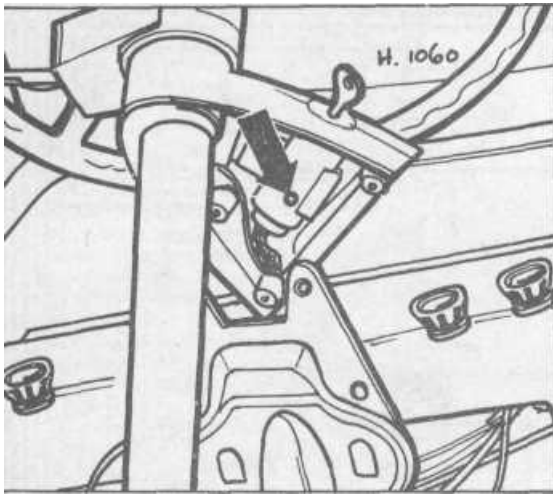


FIG. 9.10 IGNITION/STARTER SWITCH REMOVAL (SEC. 27)  
(LOCKING SCREW IS ARROWED)

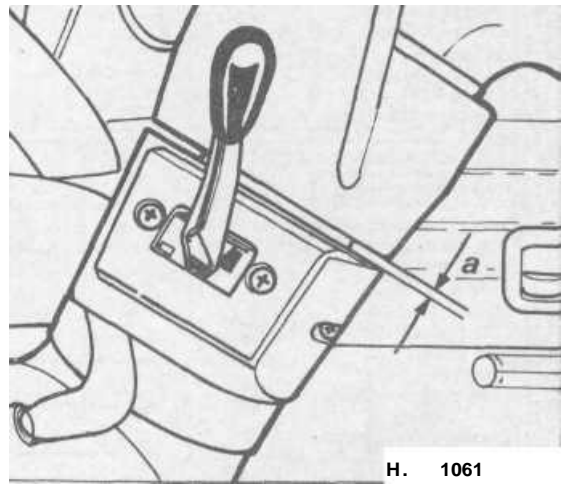
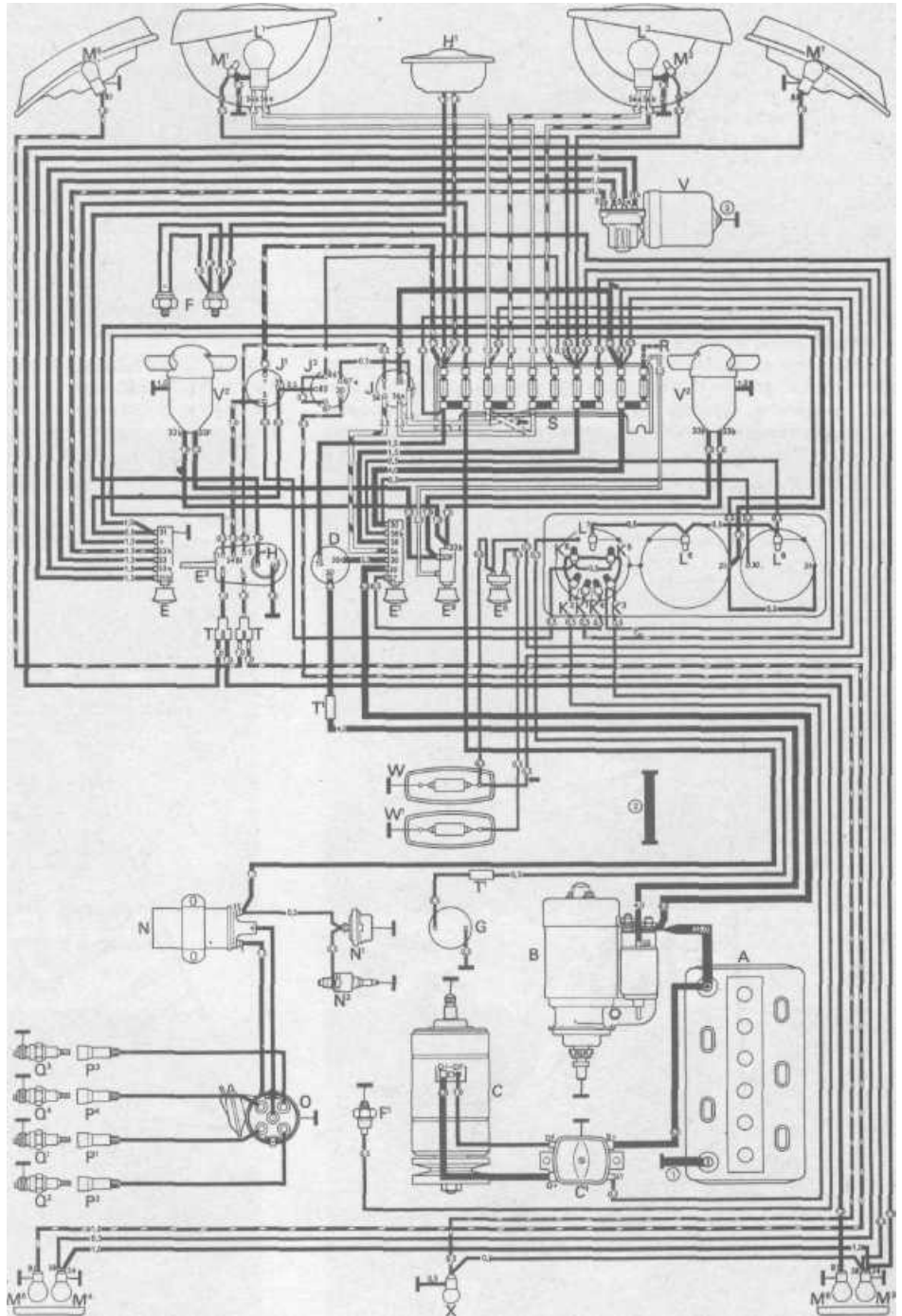


FIG. 9.11 TURN SIGNAL SWITCH MOUNTING (SEC. 28)  
(GAP 'a' IS 2 MM/0.08 INS)

WIRING DIAGRAM 1968 TO 1969 EXCEPT NORTH AMERICAN MODELS

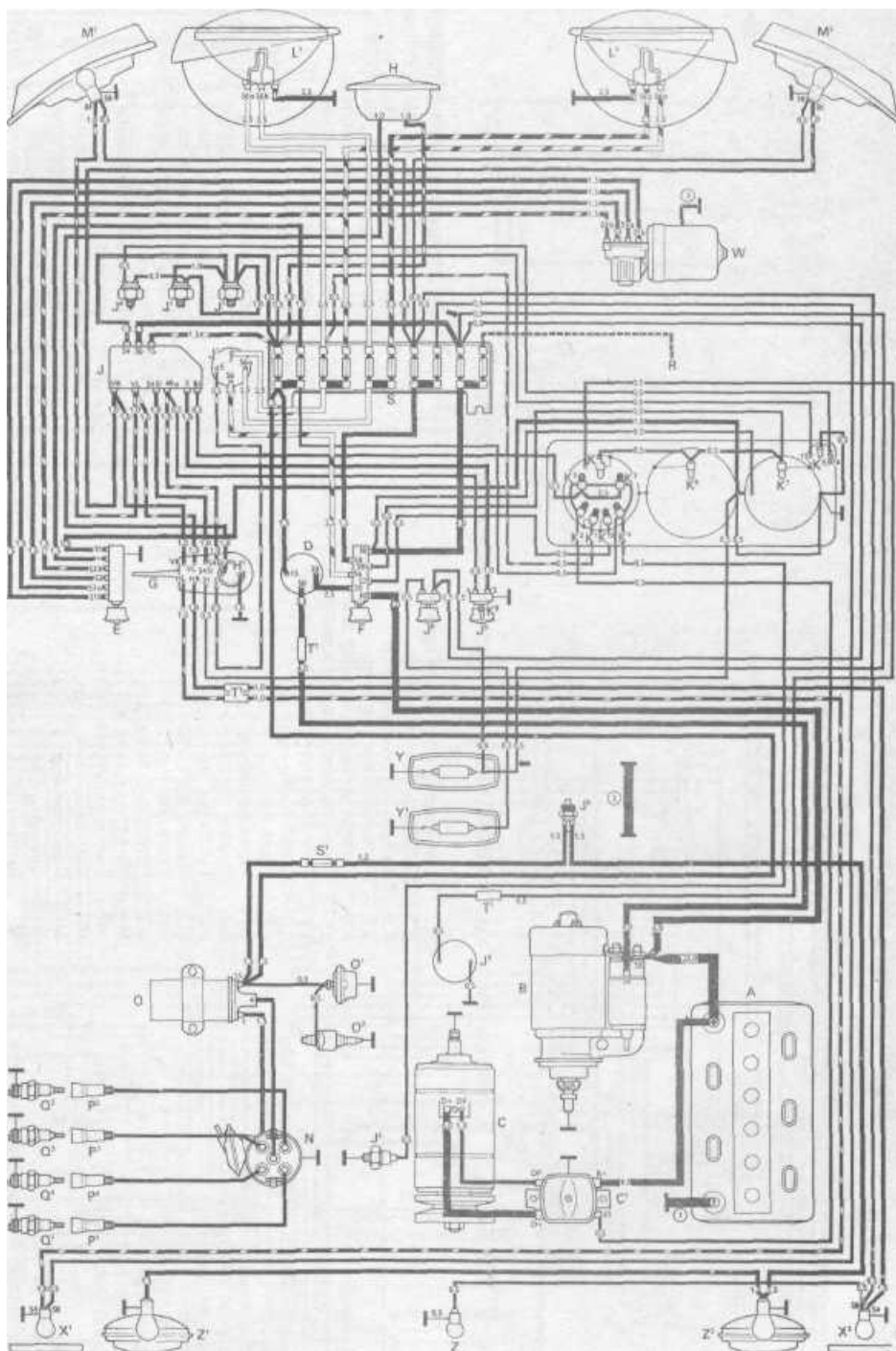
- A Battery
- B Starter
- C Generator
- C1 Regulator
- D Ignition/starter lock
- E Windscreen wiper switch
- E1 Lighting switch
- E2 Headlight flasher and dimmer switch
- E6 Interior light switch
- E9 Ventilator fan motor switch
- F Brake light switch
- F1 Oil pressure switch
- G Fuel gauge sender unit
- H Horn half ring
- H1 Horn
- J Headlight flasher and dimmer relay
- J1 Turn signal relay
- J3 Parking light relay (for Austria only)
- K1 High beam warning lamp
- K2 Generator charging warning lamp
- K3 Oil pressure warning lamp
- K4 Parking light warning lamp
- K5 Turn signal warning lamps
- L1 Twin filament bulb, left, for headlight
- L2 Twin filament bulb, right, for headlight
- L6 Speedometer light
- L7 Fuel gauge light
- L8 Clock light
- M1 Parking light, left
- M2 Parking light, right
- M3 Brake and tail lights, right
- M4 Brake and tail lights, left
- M5 Turn signal, front left
- M6 Turn signal, rear left
- M7 Turn signal, front right
- M8 Turn signal, rear right
- N Ignition coil
- N1 Automatic choke
- N3 Electro-magnetic cut-off valve (fuel)
- O Distributor
- P1 Spark plug connector, No 1 cylinder
- P2 Spark plug connector, No 2 cylinder
- P3 Spark plug connector, No 3 cylinder
- P4 Spark plug connector, No 4 cylinder
- Q1 Spark plug, No 1 cylinder
- Q2 Spark plug, No 2 cylinder
- Q3 Spark plug, No 3 cylinder
- Q4 Spark plug, No 4 cylinder
- R Radio
- S Fuse box
- T Cable adaptor
- T1 Cable connector, single
- V Windscreen wiper motor
- V2 Ventilator fan motor, front



- |    |                               |   |   |
|----|-------------------------------|---|---|
| W  | Interior light front          | 2 | Transmission to frame ground strap          |
| W1 | Interior light, rear          | 3 | Windscreen wiper motor to body ground strap |
| X  | License plate light           |   |   |
| 1  | Battery to frame ground strap |   |   |

WIRING DIAGRAM 1968 TO 1969 NORTH AMERICAN MODELS

- A Battery
- B Starter
- C Generator
- C1 Regulator
- D Ignition/starter switch
- E Windshield wiper switch
- F Lighting switch
- G Turn signal switch and hand dimmer
- H Horn
- H1 Horn button
- J Hazard warning light relay
- J1 Brake light switch (2x)
- J2 Oil pressure switch
- J3 Fuel gauge sender unit
- J4 Warning switch for brakes
- J5 Hazard warning light switch
- J6 Interior light switch
- J7 Dimmer relay
- J9 Back-up light switch
- K1 High beam warning lamp
- K2 Generator and fan warning lamp
- K3 Turn signal warning lamps
- K4 Oil pressure warning lamp
- K5 Speedometer light
- K6 Fuel gauge light
- K7 Clock light
- K8 Hazard warning light warning lamp
- K9 Brake system warning lamp
- L1 Sealed beam unit, left
- L2 Sealed beam unit, right
- M1 Parking light, left
- M2 Parking light, right
- N Distributor
- O Ignition coil
- O1 Automatic choke
- O2 Electro-magnetic pilot jet
- P1 Spark plug connector. No 1 cylinder
- P2 Spark plug connector. No 2 cylinder
- P3 Spark plug connector. No 3 cylinder
- P4 Spark plug connector. No 4 cylinder
- Q1 Spark plug for No 1 cylinder
- Q2 Spark plug for No 2 cylinder
- Q3 Spark plug for No 3 cylinder
- Q4 Spark plug for No 4 cylinder
- R Radio
- R1 Aerial connection
- S Fuse box
- S1 Back-up light fuse
- T1 Cable connector
- U1 Turn signal, front left
- U2 Turn signal, front right
- W Windshield wiper motor
- X1 Brake, turn signal and tail light, left
- X2 Brake, turn signal and tail light, right
- Y Interior light, front
- Y1 Interior light, rear
- Z License plate light
- Z1 Back-up light, left

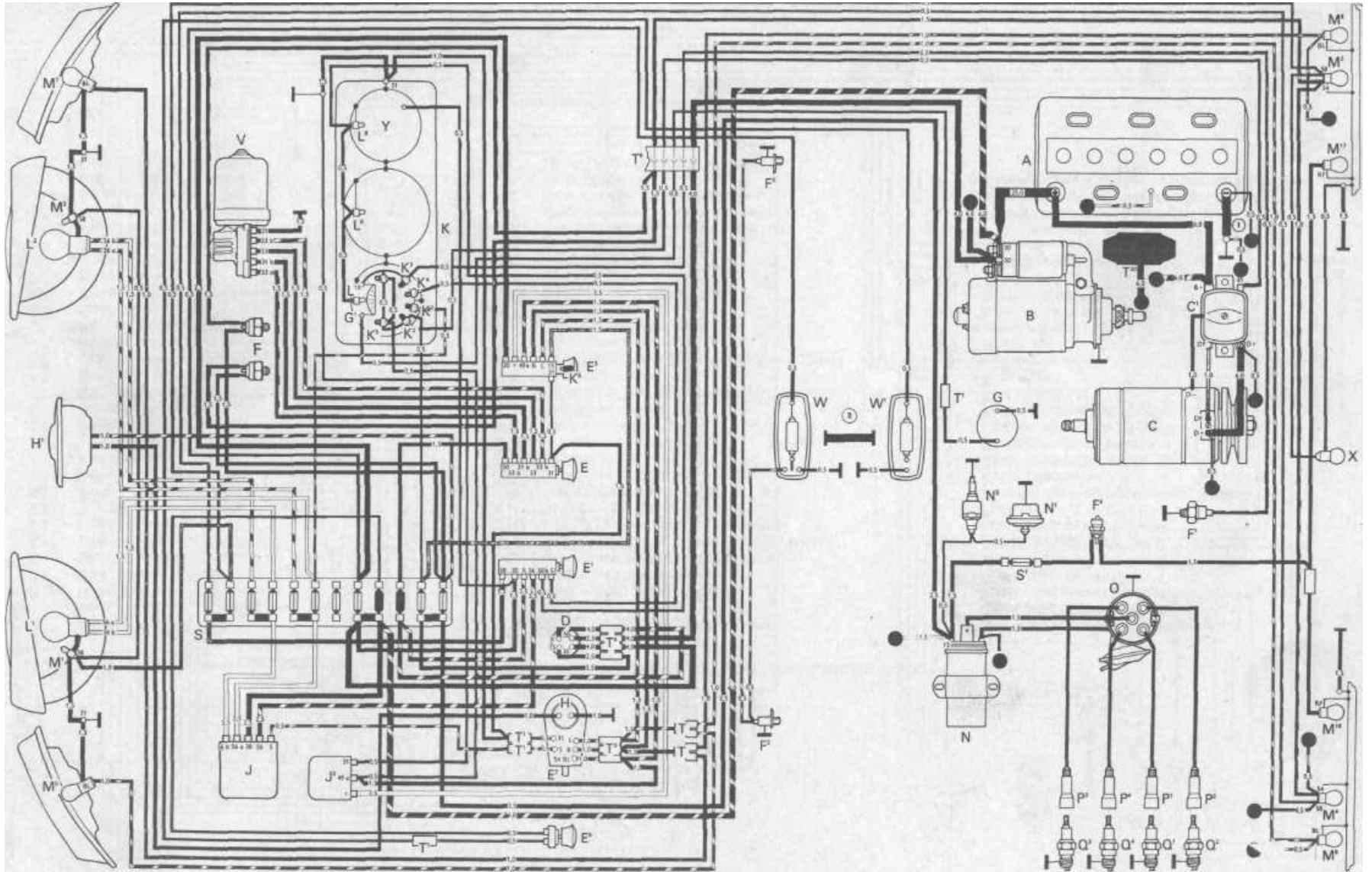


- Z2 Back-up light, right
- 3 Windshield wiper motor ground cable
- 1 Battery to body ground strap
- Black dotted lines = optional extras
- 2 Transmission to body ground strap
- All fuses: 8 amps.



### WIRING DIAGRAM 1972 ONWARDS EXCEPT NORTH AMERICAN MODELS

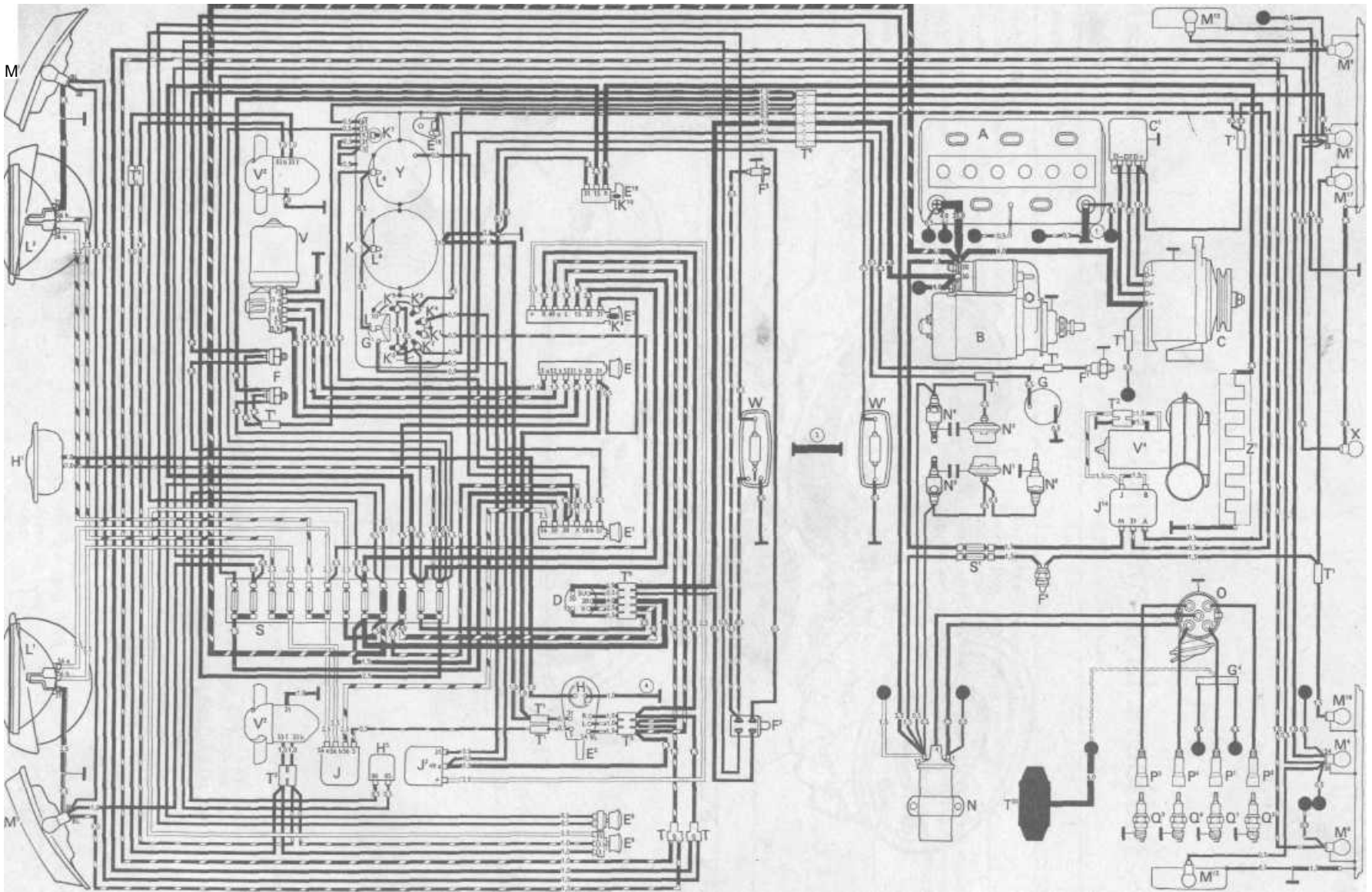
A	Battery	K2	Generator charging warning lamp	P1	Spark plug connector. No. 1 cylinder
B	Starter	K3	Oil pressure warning lamp	P2	Spark plug connector. No. 2 cylinder
C	Generator	K4	Parking light warning lamp	P3	Spark plug connector. No. 3 cylinder
C1	Regulator	K5	Turn signal warning lamp	P4	Spark plug connector, No. 4 cylinder
D	Ignition/starter lock	K6	Emergency flasher warning lamp	Q1	Spark plug. No. 1 cylinder
E	Windscreen wiper switch	L1	Twin-filament bulb, left headlight	Q2	Spark plug. No. 2 cylinder
E1	Lighting switch	L2	Twin-filament bulb, right headlight	Q3	Spark plug. No. 3 cylinder
E2	Turn signal switch (switch for hand dimmer and headlight flasher)	L6	Speedometer light	Q4	Spark plug, No. 4 cylinder
E3	Emergency flasher switch	L8	Clock light	S	Fuse box
E6	Switch for interior light rear	L10	Instrument panel light	T	Cable adaptor
F	Brake light switch	M1	Parking light, left	T1	Cable connector, single
<b>F1</b>	Oil pressure switch	M2	Tail/brake light, right	T3	Cable connector, 3 point
<b>F2</b>	Door contact switch left	M3	Parking light, right	T4	Cable connector, 4 point
F3	Door contact switch right	M4	Tail/brake light, left	T6	Push-on connector, 8 pin
F4	Reversing lamp switch	M5	Turn signal, front, left	T20	Test socket
G	Fuel gauge sender unit	M6	Turn signal, rear, left	V	Windscreen wiper motor
G1	Fuel gauge	M7	Turn signal, front, right	W	Interior light, front
H	Horn half ring	M8	Turn signal, rear, right	W1	Interior light, rear
H1	Horn	M16	Reversing lamp	X	Rear number plate lamp
J	Relay for hand dimmer and headlight flasher	M17	Reversing lamp		
J2	Emergency flasher relay	N	Ignition coil	1	Ground strap from battery to frame
K	Instrument panel insert	N1	Automatic choke	2	Ground strap from transmission to frame
K1	High beam warning lamp	N3	Electro-magnetic cut-off valve (fuel)		
		0	Distributor		



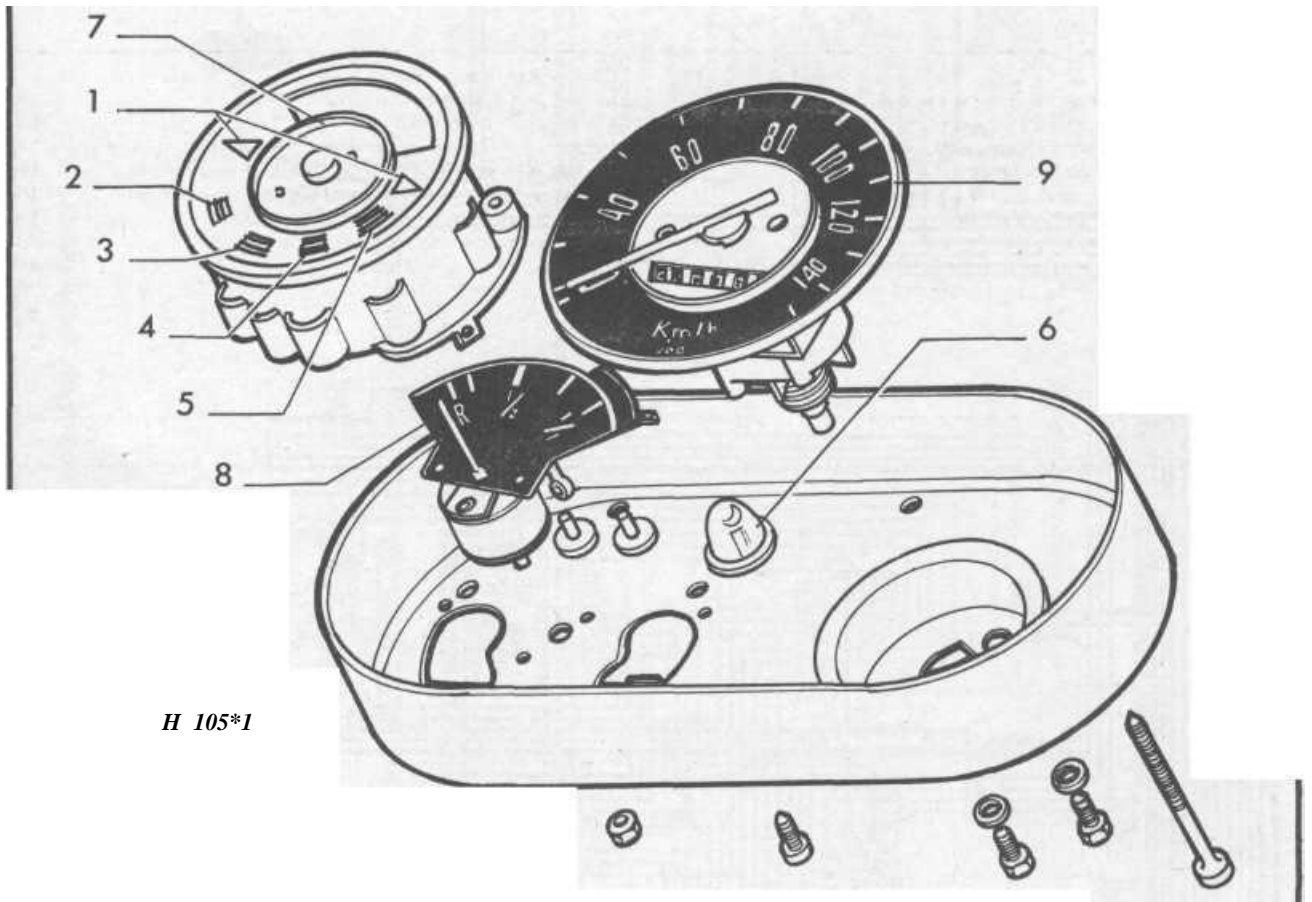
WIRING DIAGRAM 1972 ONWARDS EXCEPT NORTH AMERICAN MODELS

### WIRING DIAGRAM 1972 ONWARDS NORTH AMERICAN MODELS

A	Battery	K2	Generator charging warning lamp	P2	Spark plug connector, cylinder no. 2
B	Starter	K3	Oil pressure warning lamp	P3	Spark plug connector, cylinder no. 3
C	Generator	K4	Parking light warning lamp	P4	Spark plug connector, cylinder no. 4
C1	Regulator	K5	Turn signal warning lamp	Q1	Spark plug, cylinder no. 1
D	Ignition/starter switch	K6	Emergency flasher warning lamp	Q2	Spark plug, cylinder no. 2
E	Windshield wiper motor	K7	Dual circuit brake system warning lamp	Q3	Spark plug, cylinder no. 3
E1	Lighting switch	K10	Heated rear window warning lamp	Q4	Spark plug, cylinder no. 4
E2	Turn signal and headlight dimmer switch	L1	Sealed beam insert, left	S	Fuse box
E3	Emergency flasher switch	L2	Sealed beam insert, right	S1	Fuse for back-up lights, warm air fan
E6	Switch for interior light, rear	L6	Speedometer light	T	Cable distributor
E9	Fan motor switch	L8	Clock light	T1	Cable connector, single
E15	Heated rear window switch	L10	Instrument panel light	T2	Cable connector, double
E16	Switch for warm air fan	M2	Brake/tail light right	T3	Push-on connector, 3 point
F	Brake light switch	M4	Brake/tail light left	T6	Push-on connector, 8 point
F1	Oil pressure switch	M5	Turn signal and parking light, front, left	T20	Test socket
F2	Door contact switch, left with contact for buzzer H5	M6	Turn signal, rear, left	V	Fan motor
F3	Door contact switch right	M7	Turn signal and parking light, front, right	V2	Fan motor
F4	Switch for back up lights	M8	Turn signal, rear, right	V4	Heater fan
G	Fuel gauge sender unit	M12	Side marker lights, rear	W	Interior light, front
G1	Fuel gauge	M16	Back-up light, left	W1	Interior light, rear
G4	Ignition timing sender unit	M17	Back-up light, right	X	License plate light
H	Horn button	N	Ignition coil	Y	Clock
H1	Horn	N1	Automatic choke left	Z1	Heated rear window
H5	Buzzer for ignition key warning device	N2	Automatic choke right		
J	Relay for dimmer	N3	Electro-magnetic cut-off valve left		
J2	Emergency flasher relay	N4	Electro-magnetic cut-off valve right	1	Ground strap from battery to frame
J14	Relay for warm air fan	N8	Cut-off valve for central idling	2	Ground strap from transmission to frame
K	Instrument panel insert	0	Distributor	4	Ground cable from horn button to steering coupling
K1	High beam warning lamp	P1	Spark plug connector, cylinder no. 1		



WIRING DIAGRAM 1972 ONWARDS NORTH AMERICAN MODELS



H 105\*1

**FIG. 9.12 INSTRUMENT CONSOLE (CLOCK NOT SHOWN)**

Turn signal warning lights  
 Generator warning light  
 High beam warning light  
 Parking light warning light  
 Oil pressure warning light

6 Instrument illumination  
 light  
 7 Warning light holder  
 8 Fuel gauge  
 9 Speedometer

# Chapter 10 Suspension, dampers and steering

For information applicable to later models, see Supplement at end of manual

## Contents

General description	1	Steering gear - adjustment*	11
Maintenance - axle beams and steering linkage	2	Steering gear - removal and replacement	12
Front wheel bearing removal, replacement and adjustment	3	Steering gear - overhaul	13
Front suspension ball joints - inspection and renewal	4	Steering wheel, column and tube - removal and replacement	14
Torsion arms - removal and replacement	5	Steering linkage and ball joints - checking and renewal	15
Torsion bars (front) - removal and replacement	6	Steering damper - removal, checking and replacement	16
Stabiliser bar - removal and replacement	7	Front axle assembly - removal and replacement	17
Dampers - removal, checking and replacement	8	Steering (geometry and wheel alignment)	18
Rear suspension diagonal arm - removal and replacement	9	Wheels and tyres (to 1970)	19
Rear torsion bars and spring plates - removal, replacement and setting	10	Wheels and tyres (1971 on)	20
		Fault diagnosis	21

## Specification

Wheelbase	2,400 mm (94.5 in)	
Track		
Front - drum brakes	1,384 mm (54.5 in)	
Front - disc brakes	1,386 mm (54.6 in)	
Rear	1,426 mm (56.1 in)	
Turning circle		
Kerbs	11.3 m (37.1 ft)	
Walls	12.3 m (40.3 ft)	
Front suspension		
Type	Independent, twin transverse leaf torsion bar* with trailing arms to steering knuckles	
Torsion bars		
number of leaves	9	
length of bar	980 mm 138.6 in	
fitting angle		
pre August 1969	B* * 30°	
August 1969 on	6.0 - 1°	
Steering ball joints		
Max. play (vertical only)	2 mm (0.08 in)	
Rear Suspension		
Type	Independent diagonal trailing arm on transverse torsion bar	
Torsion bar diameter		
freight vehicles	67 • 71	28.1 mm (1.12 in)
	71 on	28.9 mm (1.14 in)
passenger vehicles	-67 - 71	26.2 mm (1.03 in)
	71 on	26.9 mm (1.06 in)
Spring plate settings		
28.1 mm bars	21° 10'	
28.9 mm bars	20°	
26.2/26.9 mm bars	23°	
Slewing	Up 10 August 1972	August 1972 onward
Type	Worm and peg	Worm and roller
Steering gear ratio	1.5:0	16.3
Overall steering ratio	15.7	17.8
Steering wheel turns, lock to lock	2%	3%

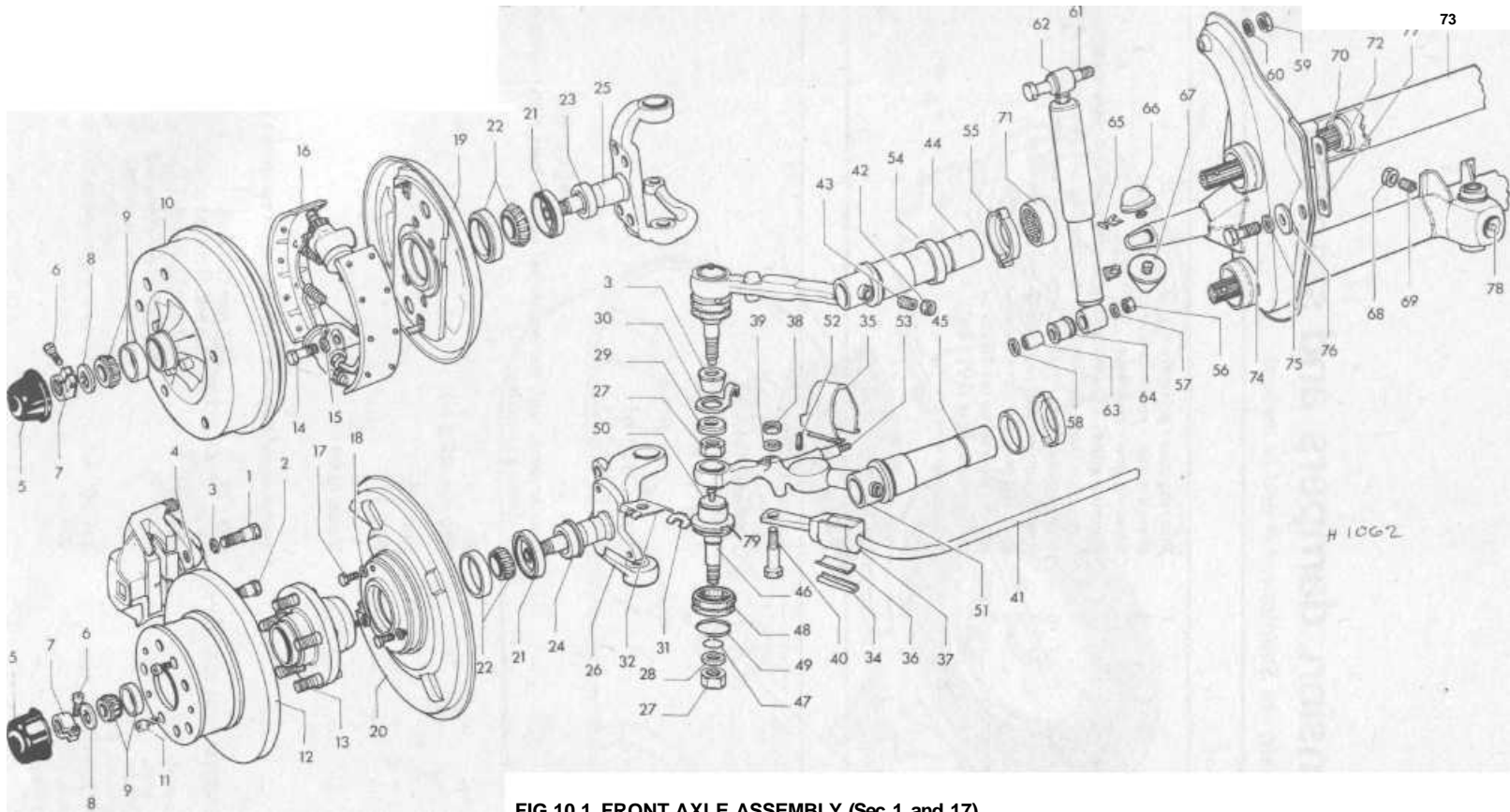


FIG.10.1 FRONT AXLE ASSEMBLY (Sec 1 and 17)

- |                               |                                  |                              |                              |   |
|-------------------------------|----------------------------------|------------------------------|------------------------------|---|
| 7 Caliper bolt                | 17 Bolt                          | 33 Eccentric bush            | 49 Ball joint retaining ring | 65 Retaining plate                      |
| 2 Shouldered bolt             | 18 Spring washer                 | 34 Retaining clip            | 50 Plug                      | 66 Bump stop buffer, upper              |
| 3 Spring washer               | 19 Backplate                     | 35 Clamp                     | 51 Sealing washer            | 67 Bump stop buffer, lower              |
| 4 Caliper                     | 20 Splash shield                 | 36 Plate                     | 52 Pin                       | 68 Nut                                  |
| 5 Hub cap                     | 21 Seal                          | 37 Stabilizer mounting       | 53 Shock absorber pin        | 69 Set screw                            |
| 6 Bearing nut clamp screw     | 22 Taper roller bearing, inner   | 38 Nut                       | 54 Seal                      | 70 Torsion bar                          |
| 7 Bearing clamp nut           | 23 Spacer ring, drum brakes      | 39 Lock washer               | 55 Seal retainer             | 71 Needle bearing                       |
| 8 Thrust washer               | 24 Spacer ring, disc brakes      | 40 Bolt                      | 56 Nut                       | 72 Metal bush                           |
| 9 Taper roller bearing, outer | 25 Steering knuckle, drum brakes | 41 Stabilizer                | 57 Lock washer               | 73 Axle beam                            |
| 10 Brake drum                 | 26 Steering knuckle, disc brakes | 42 Nut                       | 58 Lock washer               | 74 Bolt                                 |
| 11 Socket head screw          | 27 Self locking nut              | 43 Set screw                 | 59 Nut                       | 75 Spring washer                        |
| 12 Brake disc                 | 28 Washer                        | 44 Torsion arm, upper        | 60 Lock washer               | 76 Lock washer                          |
| 13 Wheel hub                  | 29 Washer                        | 45 Torsion arm, lower        | 61 Bolt                      | 77 Packing plates .5 mm                 |
| 14 Backplate bolt             | 30 Brake hose clamp-drum brakes  | 46 Ball joint                | 62 Shock absorber            | 78 Grease nipple                        |
| 15 Spring washer              | 31 Lock plate                    | 47 Ball joint retaining ring | 63 Sleeve for bush           | 79 Eccentric bush for camber adjustment |
| Front brake                   | 32 Brake hose clamp-disc brakes  | 48 Boot                      | 64 Bush                      |   |



**Steering geometry**

Toe in	
•front wheel unpressed ... ..	1571.6 mm
•front wheel 15 Kg pressure ... ..	570.6 mm
rear wheel.	±5'±10'

\*Note toe in variations of 1 571.6 mm either way are acceptable

**f Camber angle**

Front wheel. . . . .	+ 40'1 20'
Rear wheel (negative). . . . .	-50'±30'

tNote: Camber angles are greater on heavy vehicles (ambulances, fire tenders)

**Caster angle.** . . . . . **3° ±40'**

**King pin inclination** ... .. **5°**

**Shock absorbers (dampers)** ... .. Hydraulic, telescopic double acting

**Wheels and Tyres**

Type ... ..	Steel disc 5 bolt or 5 stud fixing.			
	Wheels for disc brakes have different hole positions from wheels for drum brakes			
Rims. . . . .	.To August 1971 ... 5J K x 14			
	August 1971 on 5 <sup>1</sup> / <sub>2</sub> Jx14			
Tyres				
To 1970. . . . .	.Cross ply (tubeless) 7.00-14 6PR or 8PR			
1971 on. . . . .	.Radial (with tubes) 185 R.14.C			
Pressures (psi/kgcm <sup>2</sup> ) ... ..	Cross ply		Radial	
	To % load	Full load	To % load	Full load
Front . . . . .	28/2.0	28/2.0	30/2.1	30/2.1
Rear. . . . .	35/2.5	42/3.0	30/2.1	38/2.7

**Torque wrench settings**

	lbs/ft	mkg
Wheel bolts or nuts ...	94	13
Front axle mounting bolts to frame	65-90	9-12.5
Steering damper to axle tube	29-32	4-4.5
Steering ball joint to knuckle	72	10
Stabilizer to torsion arm	25-36	3.5 - 5.0
Tie rod to steering knuckle	22	3.0
Shock absorber to torsion arm	18-25	2.5-3.5
Shock absorber to side plate	36	5.0
Drop arm to sector shaft - slotted nut	58-80	8- 11
Tie rod clamp bolt ...	11 -14	1.5- 2.0
Drag link to drop arm	14-22 *	2-3
Drag link to swing lever	14-22 *	2-3
Drag link clamp	11-14	1.5- 2.0
Back plate to steering knuckle	36-43	5- 6
Steering gear to side member	25-36	3.5 - 5.0
Diagonal arm to rear wheel bearing housing	94	13
Diagonal arm to frame	58	8
Spring plate bearing cover ...	32	4.5
Steering wheel/column nut	36	5

\* and turn to next cotter pin hole

**1 General description**

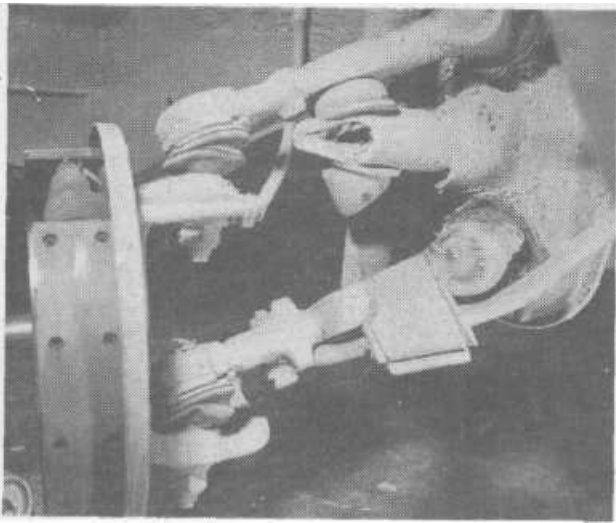
VW suspension has always been noted for its robustness and the transporter is no exception. The front suspension is identical in layout to that of the VW Beetle 1200/1300 range. It is merely scaled up to take the additional load.

Two torsion bars - made of leaves clamped together - are mounted across the vehicle, one directly above the other. Each runs in a tube and in the centre it is clamped to the tube. The outer ends fit into the tubular ends of the torsion arms (which support the wheels). These tubular ends of the torsion arms themselves fit inside the axle tubes and pivot on needle roller

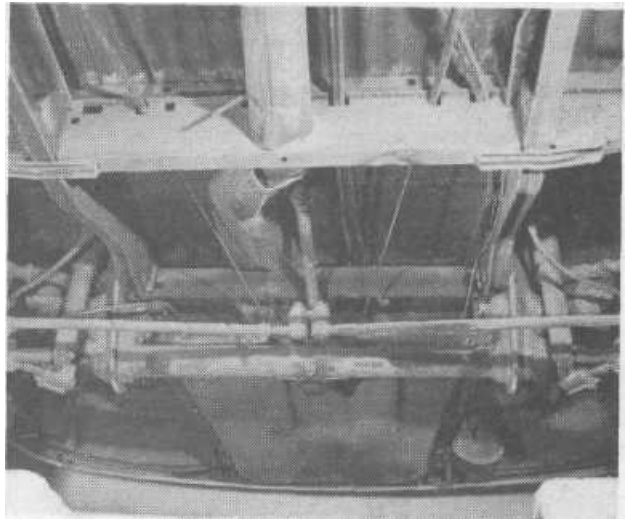
bearings and plain bushes. The rearward facing torsion arms, two on each side support the steering knuckles on ball joints (photo).

A single telescopic hydraulic damper is attached to the lower torsion arm on each side. An anti-roll bar connects the lower torsion arms on each side also.

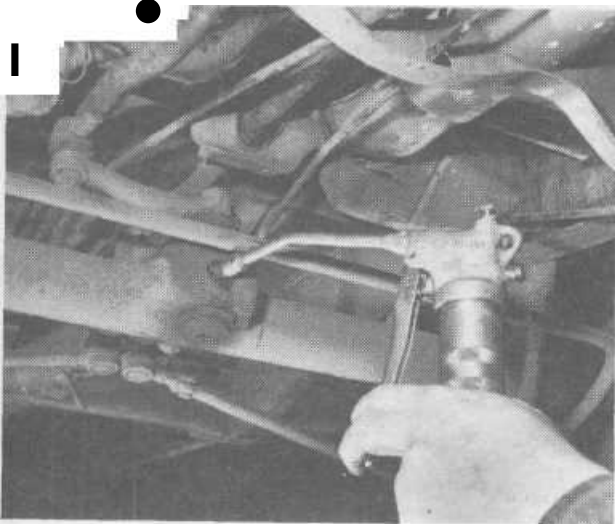
The rear suspension is torsion bar sprung also. A cross tube across the floor frame encloses two shafts the inner ends of which are locked in a splined collar in the tube and the outer ends to spring plates which connect to the diagonal arms. The diagonal arms pivot on brackets on the floor frame at the inner end and the outer end supports the wheel bearings and shaft. The drive shafts connect to the wheel shafts and transmission by means of flanges and can be removed independently.



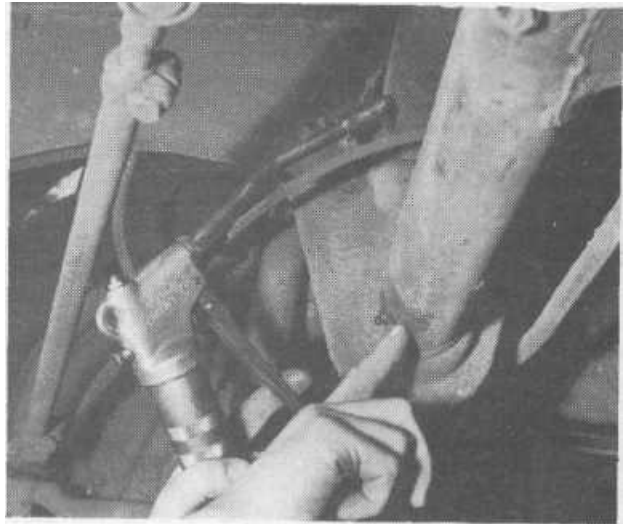
1.1a View of the steering knuckles and ball joints (wheel and drum removed to give clearer photo)



1.1b General view of the front suspension and steering linkage from beneath



2.1a Grease point in the centre of the axle beam and....



2.1b....one at each end

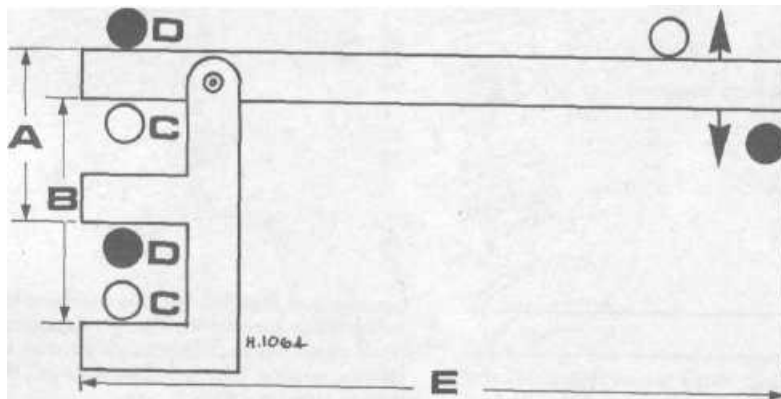


FIG.10.2 DIMENSIONS OF SPECIAL LEVER REQUIRED TO CHECK PLAY IN THE FRONT SUSPENSION BALL JOINTS (Sec 4)

A- 6"/15 cm approx  
 B- 3/23 cm approx  
 C- Position of torsion arms//

lever, for checking play in lower joint

D- Position of torsion arms/ lever for checking play

E- 2.5"/75 cm in upper joint

Prior to 1972 the steering gear was of the worm and peg type but in 1972 this changed to worm and roller. At the same time the steering ratio was increased making the steering lighter than before. The linkage from the steering gear to the wheels requires more sections due to the forward drive layout of the vehicle. From the drop arm (pitman arm) there is a drag link to a swing lever, independently pivoted and from this the tie rods run to each steering arm on the wheels. A hydraulic steering damper unit is also installed (photo).

## 2 Maintenance axle beam and steering linkage

Careful maintenance of the front suspension will save you money. Prior to 1967 there were greasing points on the tie rod ends, four on the axle tubes, four on the king pin links on either side, and two on the swing lever to service every 3000 miles. Since 1967 the tie rods do not need lubricating, one point is provided on the swing lever and one at the axle end of the steering damper. There are three points on the axle beam, one in the centre and one at each end (photo). Before greasing, which should be done annually or every 6000 miles, whichever is the soonest, jack the car up under the frame to take the weight off the front wheels and suspension, and clean off the grease nipple. If you do not take the weight off the front wheels grease will not go in. Maintenance for the rest of the suspension and steering is discussed under the appropriate section.

## 3 Front wheel bearings - removal, replacement and adjustment

1 The front wheel hubs each run on two taper roller bearings. Adjustment is effected by a clamp nut which is locked into position by a socket head screw incorporated into it.

2 The left hand front hub has a left hand thread. The axle is hollow to permit the speedometer drive cable to go through it. This cable is driven by a square hole in the bearing dust cover. Jack up the wheel and remove the securing bolts and wheel.

3 To remove the bearing dust cover, first take out the circlip securing the speedometer cable and tap the dust cover from side to side until it comes free.

4 Undo the socket head screw and undo the wheel bearing clamp nut.

5 If the thrust washer is now taken off the hub may be removed. There will be the outer races of each bearing left in the hub and the inner race of the inner bearing left on the axle. These should be drifted out of the hub from the inside if the bearings are to be renewed. If the same bearings are being replaced, they may be left in position and merely flushed out. The race on the shaft should be drifted off also. Note that if the races are renewed then the oil seal on the inner part of the hub will be driven out at the same time as the race. This must be renewed as well.

6 It is possible that the bearing race is a loose fit on the shaft. If this is so, which would tend to let it turn, a few centre punch marks around the axle where it fits will give it some grip once again when fitted.

7 Refitting new bearings means that the outer races will first have to be driven into the hub and the new oil seal fitted on the inside. Coat the bearings and the space between them in the hub with liberal quantities of Castrol LVM Grease and place the hub back on the shaft. Fit the outer bearing followed by the thrust washer and screw on the clamp nut (photos).

8 To adjust the bearing endfloat correctly the nut should be tightened up firmly to make sure the bearings are properly located, spinning the wheel at the same time to ensure the bearings are not overtightened. Then the nut should be backed off until the axial play is between 0.03 - 0.12 mm (0.001 - 0.005 inch) at the spindle. This seems quite a lot and can result in some quite noticeable rock at the outer rim of the wheel. It is nevertheless correct although the axial play should be kept to the lower limit where possible. When correct tighten the socket screw (photo).

9 Replace the hub cover and re-secure the speedometer drive cable where appropriate.

## 4 Front suspension ball joints - inspection and renewal

1 With the exception of the correct setting of the camber adjusting bush on the upper joint pin there are no adjustments which can be made. When the joints are worn beyond specification limits they must be renewed. Each joint has a removable plug (photo). When removed, a grease nipple can be fitted to add more grease if the joint should squeak. Regular greasing is not necessary. These plugs are not fitted for this reason. They merely cover a special recess which is used in conjunction with a special jig for checking that the arm is not bent. Later models do not have the plugs. A special recess is machined to the body of the joint.

2 Testing of the play in the suspension ball joints cannot be carried out as on some cars by the accepted method of jacking up the vehicle and then lifting the wheel independently. This is because the lower halves of the ball joint bearing cups are strongly spring loaded. The play is therefore measured by drawing the pins of the ball joints downwards to see how far they move. As the pins are attached to the steering knuckle this means that the wheel has to be moved downwards in relation to the torsion arms. This is done by means of a lever with a pivoting hooked section attached (see Fig.10.2). To check the lower joint play hook the swinging section under the lower torsion arm and lever the upper torsion arm down. To check the upper joint put the hook and arm between the torsion arms to lever the upper arm up.

3 In order to renew the ball joints they have first to be removed from the knuckle by unscrewing the taper pin nuts and pressing them out of the knuckle eyes with a claw clamp. This may be done without removing the hub or backplate but care must be taken to avoid damaging the hydraulic pipe. If a claw clamp is not available and it is known that the ball joints are going to be renewed anyway it is possible to loosen the tapers by striking the sides of the eyes in the steering knuckle. Such striking should be firm and smart. Excessive striking could distort the knuckle.

4 The ball joints then have to be removed from the torsion arms. As they are a splined press fit into the torsion arms the torsion arms will have to be removed. This is not difficult (see next section).

5 With the torsion arms removed the best thing to do is to take them along to a VW agent and get him to fit the new ball joint to them. Without the proper press tools the greatest difficulty will be encountered in removing the old joints and installing the new ones. If the torsion arm should get damaged it could be very expensive.

6 The eccentric bush on the upper joint pin will have to be removed and fitted to the new joint.

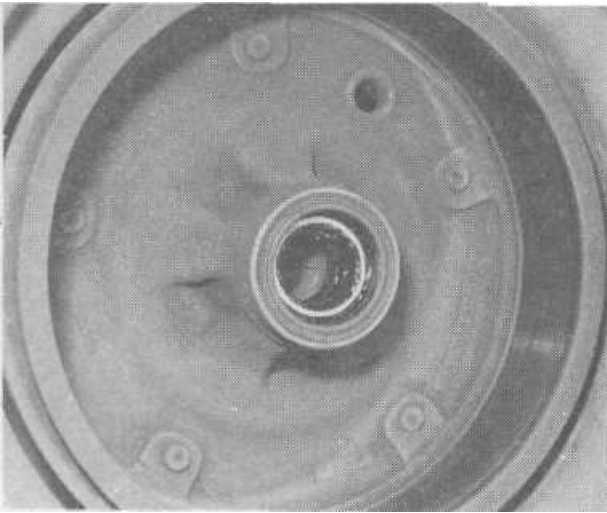
7 Replace the torsion arms and then refit the ball joint pins into the steering knuckle. Note that the eccentric bush of the top joint pin has a notch which normally faces forward. If the notch did not face forward on the joint you took off then it would be as well to have the steering geometry checked out completely. This is a wise precaution in any case.

## 5 Torsion arms - removal and replacement

1 If indications show that a torsion arm is damaged then it must be renewed.

2 First remove the wheel hub assembly. If a lower torsion arm is being removed the stabiliser bar must also be taken off (see Section 7.)

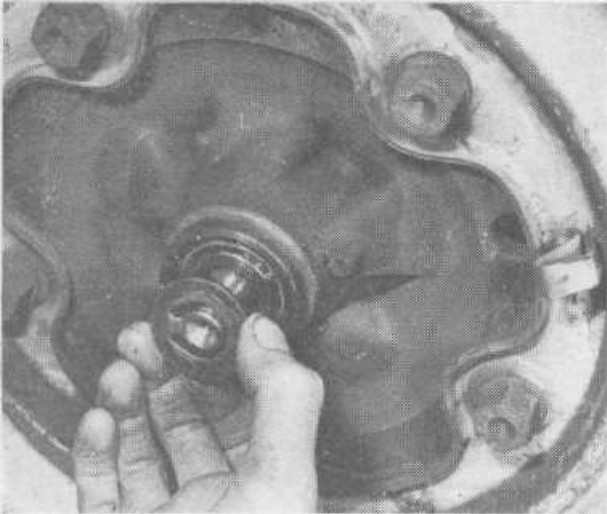
3 Loosen the locknuts on the ends of the torsion arm securing and then screw the pins right out. The torsion arm can then be pulled out of the axle tube. The torsion arm tube is positioned in two bearings - an inner bush and outer needle roller. If either of these is seriously worn causing radial movement of the torsion



3.7a Bearing packed with grease



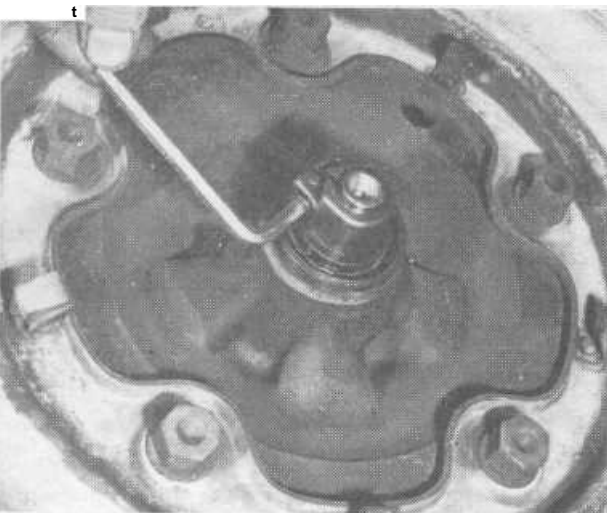
3.7b . . . fit the outer bearing



3.7c . . . followed by the thrust washer . . . .



3.7d . . . replace the clamp nut



3.8 . . . and tighten the socket head sere



4.1 The plug may be replaced by a grease nipple

arm they should be renewed by a specialist with the correct tools. If you have already carried the dismantling of the front axle a considerable way it may be simplest to disconnect the brakes and steering gear as well and detach the whole assembly from the car. This can be done by removing the four securing screws (see Section 12 for complete procedure).

### 6 Torsion bars (front) - removal and replacement

- 1 One would normally only need to remove a torsion bar if it broke and this is a rare occurrence.
- 2 First remove the hub and steering knuckle and torsion arm from one end of the torsion bar concerned. Then detach the steering knuckle from the torsion arm on the opposite side but do not remove the other arm from the torsion bar.
- 3 If the upper bar is to be removed it will be necessary to detach the gearshift rod at the coupling and push it to one side. For the lower bar the shock absorber will have to be removed.
- 4 In the centre of the torsion bar tube slacken the locating screw locknut and remove the screw. The bar and the attached torsion arm may then be drawn out.
- 5 The torsion bar is composed of a number of leaves. Make sure that any replacement is of the correct type.
- 6 When refitting a torsion bar make sure first it is liberally coated with grease and position it so that the recesses for the locating screws will line up. Fix the centre screw and locknut and then reassemble the torsion arm and steering assemblies in the reverse order of dismantling.

### 7 Stabiliser bar - removal and replacement

- 1 The stabiliser bar is fixed to the lower torsion arms on each side of the vehicle and is clamped in position. The bar is held by clamps secured by sliding clips. Drive off the clips against the taper having bent down the securing tab and then remove the clamp, plate and buffer blocks. Remove the bolts securing the ends of the bar to the torsion arms.
- 2 When refitting the clamps make sure they are the correct way round - cut out portion towards the wheel - and then fit the plate and sliding clip. A good pair of long handled pliers will be needed to squeeze the clamp so that the clip can be engaged. Bend up the lock tab on the clip when it is in position.

### 8 Dampers - removal and replacement

- 1 Front dampers are removed by undoing the nut and bolt holding the upper end to the front axle beam end plate and then removing the nut holding them to the stud in the lower torsion arm. When refitting the damper fit the lower end first.
- 2 Rear dampers are mounted similarly. The top end is held by a bolt which screws into a captive nut in the side frame bracket. Note that there is a lock washer on each side of the bush. The lower end is held by a nut and bolt through a lug on the rear wheel bearing housing.
- 3 When the bushes go on a front damper at the bottom (photo) there is always the possibility that the mounting stud will be worn. If the threads are rusty you may even break it when attempting to undo the nut. New studs can be fitted but the old one has to be cut off, drilled out and the hole reamed so that an oversize replacement pin may be securely driven in.
- 4 Dampers should be checked by holding them vertically the right way up and then closing and extending them fully. There should be firm, uninterrupted resistance throughout the range of movement of the piston. The resistance should be equal in each direction. Any tight or free spots indicate that the internal seals have failed. The unit must therefore be renewed. If there are signs of excessive oil leakage this indicates that the damper should be taken off for checking. Small leaks do not necessarily indicate failure.

### 9 Rear suspension diagonal arm - removal and replacement

- 1 To remove the diagonal arm first jack up the vehicle and disconnect the outer end of the drive shaft from the wheel shaft (see Chapter V). The rear brakes may be removed with the axle and wheel shaft if wished in which case the hydraulic pipe connection should be undone. Otherwise the wheel shaft must be slackened whilst the car is still on its wheels. The brake drum and backplate complete with shoes may then be taken off (see Chapter 8).
- 2 Before undoing the bolts securing the spring plate to the diagonal arm it is important to mark both the arm and plate with a chisel before moving their relative positions. The rear wheel geometry can be upset if this setting is lost.
- 3 Unclip the brake pipes from the arm.
- 4 The inner end of the diagonal arm pivots on a bolt. Once this is undone the arm may be taken out. The bushes on the diagonal arm are not renewable - they are vulcanised to the arm. A complete new arm must therefore be fitted.
- 5 When replacing the pivot bolt it must be tightened to the correct torque of 87 lb/ft.
- 6 When clamping the spring plates back to the diagonal arm the line up marks made on dismantling must correspond.
- 7 If extensive repairs are being made (due to damage) which call for renewal of the arm it is important to have the suspension checked on a VW alignment jig after assembly.

### 10 Rear torsion bars and spring plates - removal, replacement and setting

- 1 Before the nuts and bolts attaching the spring plates to the diagonal arm are loosened the relative positions of the arm and the plates must be marked with a chisel.
- 2 The spring plate rests on a lug in the frame casing along its lower edge and to relieve residual tension in the torsion bar must be sprung out so that it rides over the lug. This can be done quite easily with a tyre lever.
- 3 At this stage the setting of the suspension can be checked. The angle of the plate in this unstressed position should be indicated in the specifications according to the model from the horizontal line of the vehicle body. For this measurement there fore a spirit level and protractor are needed. The horizontal line of the vehicle is taken from the bottom of the door opening in the body shell. Using a level and protractor work out how far this deviates from the true horizontal.
- 4 Measure the angle of the spring plate from the true horizontal in the same way, eliminating any play there may be by lifting the plate while the measurement is taken.
- 5 Depending on which way the body deviates, the angle is added or subtracted to the plate angle to give the difference between the two. Reference to Fig.10.4 will illustrate the examples given below.

Body deviation angle	
Plate deviation angle	21° 10'
Plate/body angle (AA)	16° 10'
Plate/body angle (BB)	2° 50'

If the correct plate/body angle is 21° 10' then in situation AA the plate angle needs increasing by 5° 10'. In BB it needs decreasing by 2° 50'.

- 6 The torsion bars are splined at each end. The inner end is anchored to a splined bracket fixed in the centre of the cross tube. The outer end is splined to the spring plate until 1971. The inner end has 44 splines (8° 10' per spline) and the outer end has 48 splines (7° 30' per spline) affording an alteration possibility in graduations of 40'. (8° 10' - 7° 30'). After 1971, the number of splines is 48 inner, 52 outer.

In example AA, if the inner end of the torsion bar is rotated anti-clockwise 8 splines (65° 20') and the spring plate rotated

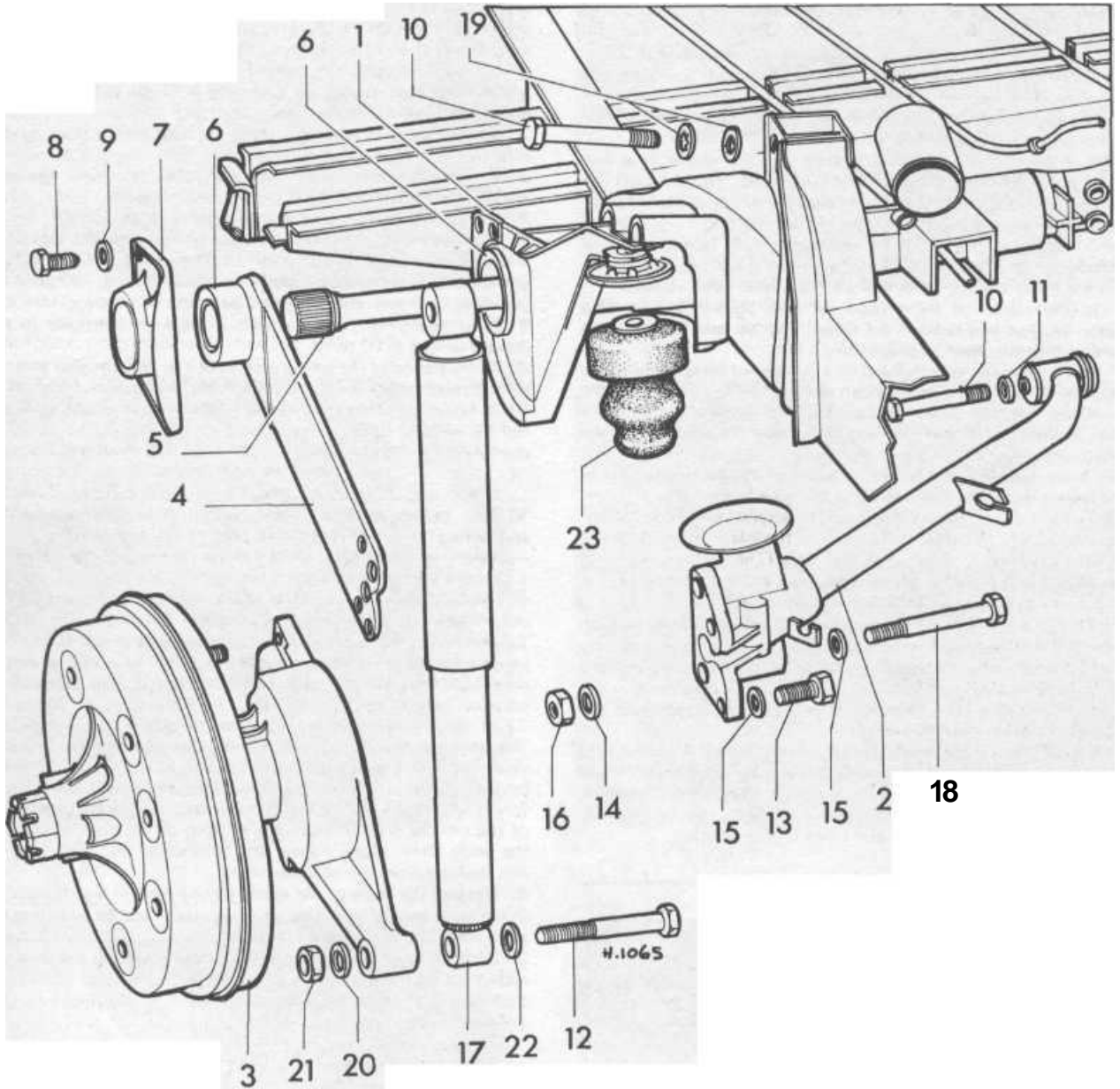


FIG.10.3 REAR SUSPENSION ASSEMBLY (Sec 9)

- |                          |                                  |                   |                  |
|--------------------------|----------------------------------|-------------------|------------------|
| 1 Frame                  | 7 Cover for spring plate bearing | 13 Bolt           | 19 Lock washer   |
| 2 Diagonal arm           | 8 Bolt                           | 14 Washer         | 20 Spring washer |
| 3 Bearing housing        | 9 Spring washer                  | 15 Spring washer  | 21 Nut           |
| 4 Spring plate           | 10 Bolt                          | 16 Nut            | 22 Washer        |
| 5 Torsion bar            | 11 Spring washer                 | 17 Shock absorber | 23 Buffer        |
| 6 Inner and outer bushes | 12 Bolt                          | 18 Bolt           |                  |

clockwise on the outer end by 8 splines (60°) the net increase in the angle will be 65° 20' less 60° which is 5° 20' and as near as one can get.

In example BB the inner end of the bar is rotated clockwise 3 splines (24° 30') and the plate on the outer end anti-clockwise 3 splines (21° 30'). The net decrease in the angle is then 3°.

7 To withdraw the torsion bar sufficiently to rotate the splines for adjustment first remove the four screws which secure the cover clamping the rubber cushion mounting. The spring plate can now be pulled off the torsion bar and at the same time the inner end of the bar may be drawn out of the centre splined location. (Note that torsion bars are not interchangeable side for side).

8 Having reset the torsion bar so that the plate angle is correct make sure that the rubber mounting bushes are in good condition. Renew if in doubt. Cover with flake graphite (to prevent squeaking) and make sure the inner one is installed the proper way up. (The top edge is marked 'Oben'). Before the cover is reinstalled over the rubber bush it will be necessary to raise the plate above the stop lug on the frame casting. If this is not done now the pre-loading of the rubber bushing will be all wrong when the cover is put back. It will also be very nearly impossible to move the plate. To lift the plate put a jack under the end. If it looks as though the vehicle is going to lift before the plate is up in position get some people to sit in the back for a minute or two. With the plate held in position replace the cover plate and setscrews.

9 It may be difficult to get the four plate securing screws to pick up their threads on replacement - particularly with a new bush. In such instances two longer screws will have to be obtained and used diagonally so that the plate may be drawn down enough to refit the shorter screws. (The short screws must be used finally otherwise the cover plate will not pull down far enough to stress the rubber bush properly).

10 With the cover tightened down the diagonal arm may be reassembled to the spring plate.

11 The angle adjustment of the spring plates must be the same on both sides of the car.

12 If the spring plates have been renewed or any other work has been carried out on the rear suspension which could affect the alignment then it is important that the camber and toe settings be checked with alignment equipment. It would also be timely to mention here that if the rear suspension spring plate settings are purposely altered to give an increased or reduced ground clearance then the effects on handling under certain circumstances are, to say the least, unusual. Tyre wear is also greatly increased if the rear wheel alignment is incorrect.

## 11 Steering gear - adjustments

1 If play in the steering can be positively traced to the steering gear rather than wear in the linkage it is possible to make certain adjustments (with the steering gear fitted in the car) to improve the situation. On the worm and peg type steering gear fitted up until 1972, the only adjustment is by means of a screw in the cover which is held by a locknut. Movement of this screw inwards forces the lever shaft (and thus the peg which is fitted to it) closer to the worm. The peg is tapered and consequently if it is moved further in it reduces the clearance between it and the channel of the worm. Before attempting any adjustment make sure that the swing lever is not a loose fit in the bushes in the gear case. If they are worn the whole unit will need removal, and overhaul. The cover bolts and mounting bolts must all be correctly tightened.

2 To make the adjustment jack up the front of the vehicle until both wheels are clear of the ground. Then, with one person in the cab turning the steering wheel from lock to lock gradually turn the adjusting screw in until the 'feel' of the steering wheel is •net-too loose but at the same time not stiff. Lock up the adjusting screw with the nut.

3 Any play in the worm spindle bearings is detectable by watching to see if the column coupling flange moves up and down when the steering wheel is moved. If it does, it means that the end float needs adjustment and this can only be carried out satisfactorily by removing the steering gear and adjusting the shims under the end cover. It is possible to remove these shims with the gear installed but great care must be taken to keep out dirt and to avoid the possibility of taking out too many shims which would cause excessive stiffness and damage the bearings.

The worm and peg steering gear is filled with SAE 90 oil which does not normally require changing. It can be checked and topped up by removing the plug at the top of the gear case cover (photo).

4 From August 1972 a worm and roller type gear has been fitted. This works in much the same fashion as the earlier type except that the peg is now replaced by a roller which engages the worm. This increases the contact area and cuts down the rate of wear. Adjustment is the same as on the earlier type except that it is not checked by the drag method. To adjust the idler to the worm means eliminating any clearance. This clearance is measured by turning the steering wheel from side to side around the straight ahead position with the front wheels raised from the ground. Assuming there is no play in the steering linkage there should be no more than 15 mm peripheral movement of the steering wheel before resistance is felt at each side (wheels start to turn).

5 To adjust this the drag link should be first separated from the drop arm. This will make it easier to judge the clearance at the drop arm rather than through the steering column. Turn the steering wheel just over ½ turn to left or right of the central position. The central position is indicated on the steering gear by a pointer on the worm spindle dust cap which lines up with a raised lug on the worm spindle cap.

6 Slacken off the adjusting screw locknut and back off the screw one turn. Then carefully screw the adjuster in, all the while rocking the drop arm until no further backlash can be felt. If after making this adjustment there is still an excess of play in the central position further slight adjustment may be made to compensate but it indicates that wear is developing. Once the wear in any part of the roller type steering gear becomes excessive the whole unit has to be replaced. Parts for overhaul and repair are not available.

7 The worm and roller steering gear is oil filled in the same way as the early type and may be checked and topped up to the edge of the filler plug hole in a similar fashion.

## 12 Steering gear - removal and replacement

1 Remove the turn signal switch from the steering column under the steering wheel (see Chapter 9).

2 Remove the under tray below the front of the vehicle.

3 Separate the drag link from the drop arm. This is best done with a suitable puller if damage to either is to be avoided. The drop arm has then to be pulled off the steering shaft with a two arm puller once the securing nut is removed. Any method other than a puller is likely to cause damage to the arm. Damage to the steering gear will also result but of course this does not matter if you are going to renew it anyway.

4 Bend back the tabs of the lockplate which lock the single securing nut and bolt of the steering column coupling and withdraw the bolt after removing the nut.

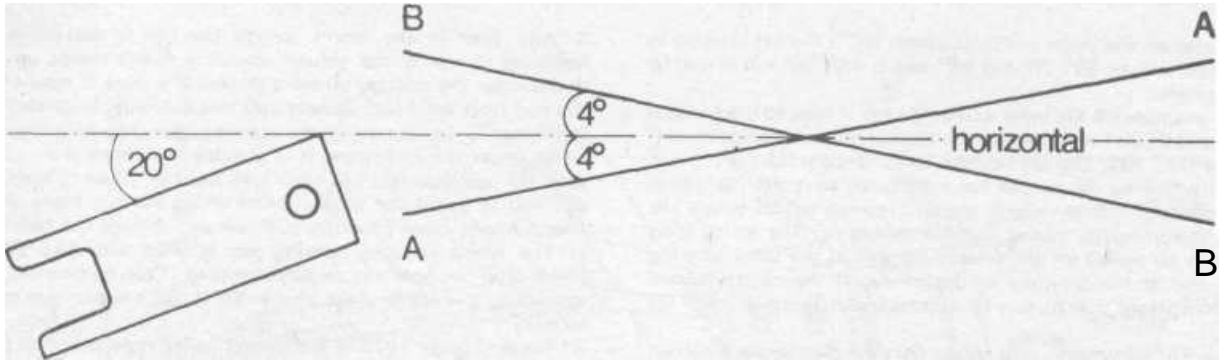
5 Remove the four bolts holding the steering gear case to the side member.

6 Push the steering coupling together with the column upwards so that the steering gear can be taken out.

7 When refitting the steering gear make sure it is filled with oil.

8 Make sure that the notch on the drop arm lines up with the notch on the shaft. On later models the drop arm has two notches marked 'L' and 'R' for left and right hand vehicles as appropriate. When fitting the drop arm it must not be hammered but drawn on to the splines with the securing nut.

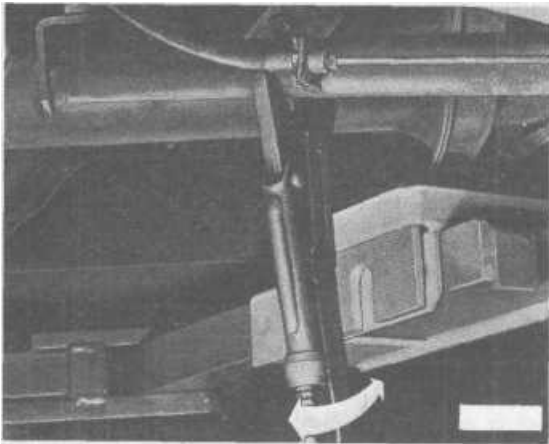




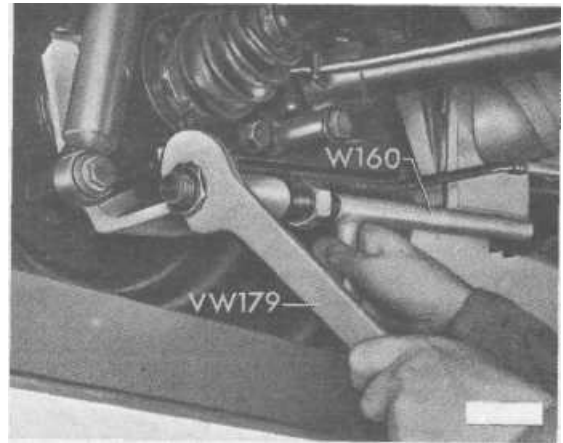
near suspension spring plate angle

body line angle

**FIG.10.4 REAR SUSPENSION. SPRING PLATE SETTING ANGLE CALCULATION- (Sec 10)**



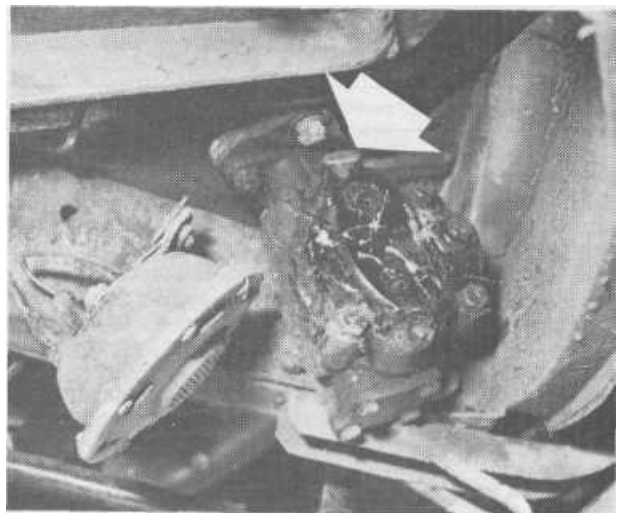
**FIG 10.5 ADJUSTING REAR WHEEL CAMBER BY ALTERING THE TORSION BAR ANGLES THROUGH ROTATION OF THE DIAGONAL ARMS (Sec. 10)**



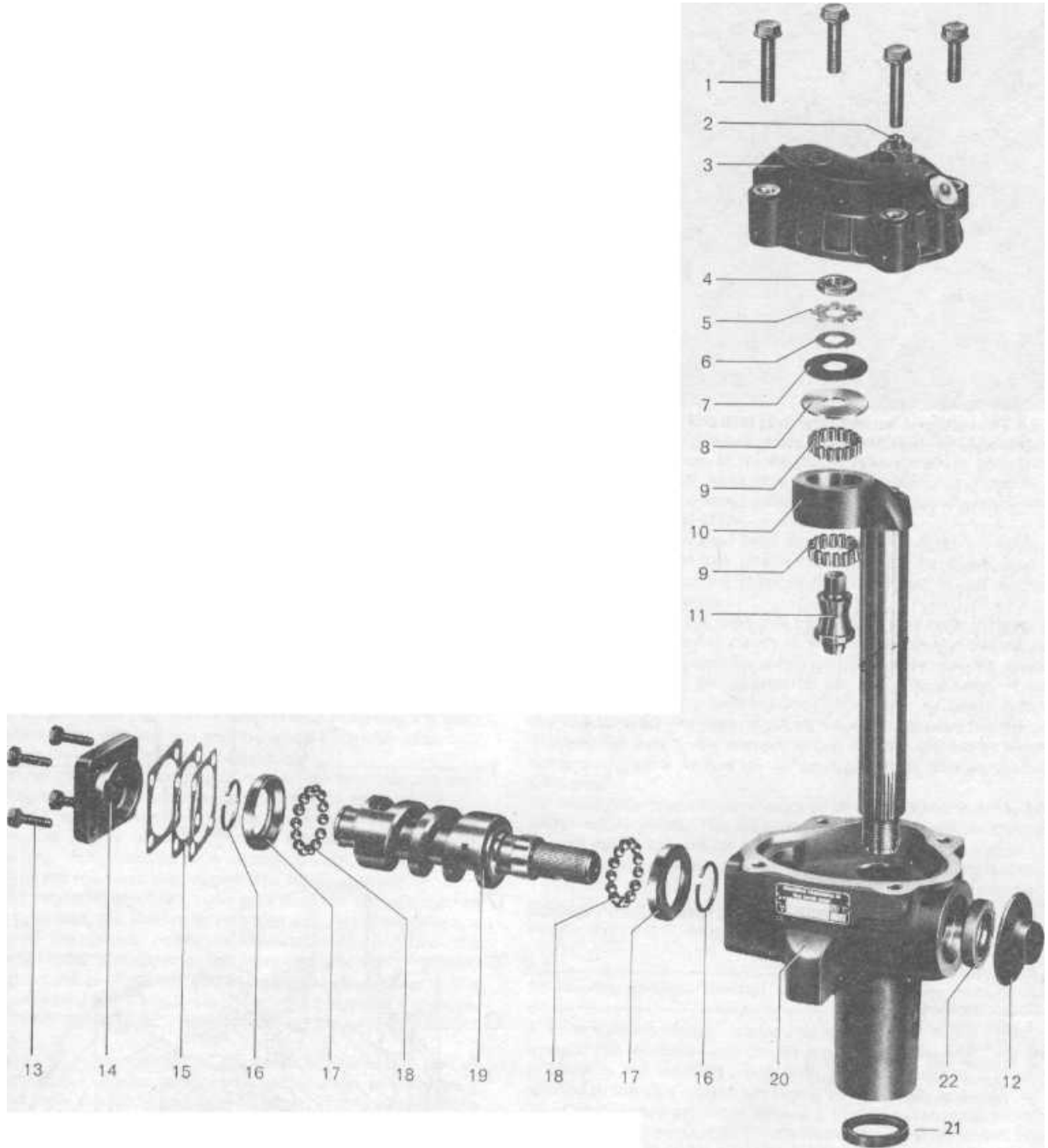
**FIG 10.6 ADJUSTING REAR WHEEL TOE-IN USING SPECIAL SETTING TOOLS AND AXLE TUBE FLANGE BOLTS LOOSENED (Sec. 10)**



**8.3 Inspect the shock absorber bushes. These need renewal**



**11.3 The plug at the top of the steering gear casing (arrowed)**



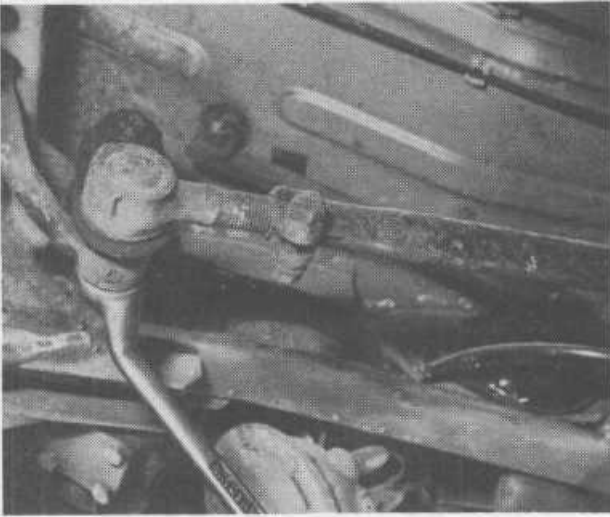
**FIG. 10.7 WORM AND PEG STEERING GEAR - COMPONENTS**  
(Sec 13)

1 Bolt and washer  
2 Adjusting screw and lock nut  
3 Cover for gear case  
4 Nut  
5 Tab washer  
6 Washer

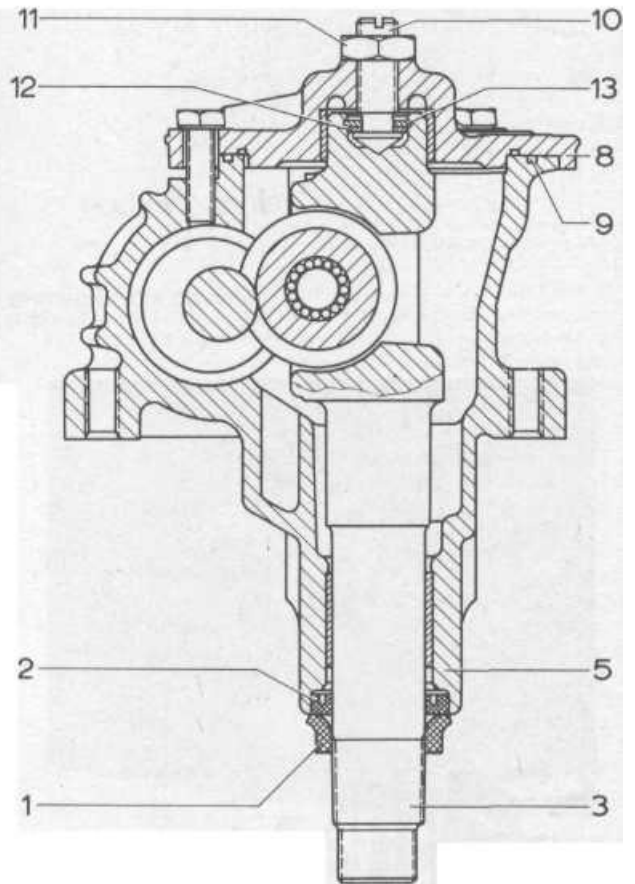
7 Spring washer  
8 Special washer  
9 Taper rollers  
10 Lever shaft  
11 Peg  
12 Dust seal

13 Bolt and washer  
14 End cover  
15 Shim  
16 Retaining ring  
17 Ball race

18 Steel balls  
19 Steering worm  
20 Steering gear case  
21 Steering shaft seal  
22 Seal, with dust lip

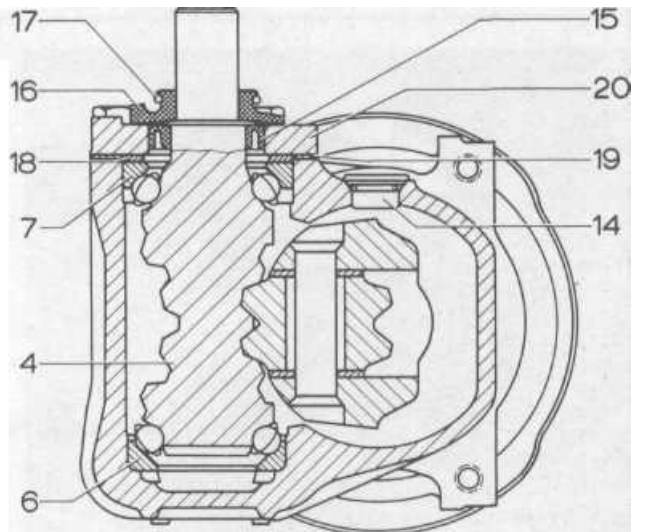


15.4 The ball joint between the drag link and the drop arm; note the number of threads visible before undoing the clamp



**FIG. 10.8 WORM AND ROLLER STEERING GEAR - CROSS SECTIONS (Sec 13)**

- 1 Roller shaft dust seal
- 2 Oil seal
- 3 Roller shaft
- 4 Worm shaft
- 5 Housing
- 6 Lower ball thrust bearing
- 7 Upper ball thrust bearing
- 8 Housing cover
- 9 Housing cover seal
- 10 Roller shaft adjusting screw
- 11 Adjusting screw lock nut
- 12 Guide washer
- 13 Ore lip
- 14 Oil filler plug
- 15 Oil seal
- 16 Dust cap, worm shaft
- 17 Circlip
- 18 Dished washer
- 19 Shims
- 20 Worm spindle cap



### 13 Steering gear - overhaul

1 The decision to dismantle and rebuild a steering gear assembly will depend to a large extent on the availability of parts. It is inevitable that if adjustments fail to rectify play adequately then most of the interior components will need renewal. The steering gear is subject to some very critical settings and requires shims and jigs which only a Volkswagen agency is likely to have. We do not therefore, recommend that the do-it-yourself owner attempts this job. On the later models (August 1972 on) which are fitted with worm and roller steering gear it is not intended that overhaul is carried out anyway. Worn units must be replaced complete.

### 14 Steering wheel, column and tube - removal and replacement

1 **The** forward drive design of the vehicle means that the steering column shaft is mounted much nearer the vertical than in a conventional car. For this reason no special safety features are incorporated because in the event of a collision there is no danger of the shaft impaling the driver. There are therefore no complications in removal and replacement.

2 To remove the steering wheel prise out the centre cap for the horn button and remove the turn signal switch from the column. Undo the wheel securing nut and take it off together with the spring washer (on later models) and the turn signal cancelling ring. The wheel may then be pulled off. If tight pull it upwards and strike the centre shaft downwards with a soft drift of some sort to free it.

3 To remove the column shaft remove the screws securing the cap at the base of the tube inside the driving compartment and make sure the ignition key is not in the locked position. Then remove the undertray at the front and remove the steering gear as described in Section 12 The column shaft may then be drawn out from underneath.

4 The column tube can be removed without removing the shaft if required. First take off the steering wheel as described already and ensure the column is not locked.

5 Remove the securing screws from the tube base cap and then the circlip holding the rubber bush at the top of the tube.

6 Lift the tube a little so that the horn earth cable may be disconnected at the bottom and then straighten out the connection tag. Pull the cap and plastic clamping ring off the bottom of the tube and then remove the tube upwards.

7 When replacing the tube make sure that the elongated holes in the tube and the insulating ring line up. The procedure is a reversal of the removal operation. Remember to bend back the tag at the bottom at right angles after the base cap is refitted. When the tube is finally in position see that the hole is in line **with** the locking pin. Turn the ignition key to see that it engages. The column upper bearing spring support ring goes in shoulder upwards.

It must be remembered that the column tube acts as part of the earth return for the horn circuit and so must be effectively insulated from the body and steering shaft. If it is not the horn **will** operate as soon as the ignition is switched on.

### 15 Steering linkage and ball joints - checking and renewal

1 The steering wheel transmits the movement to the wheels via the steering column, then the steering gear and finally from the steering gear drop arm along a drag link to the relay lever and thence by a tie rod to the steering arm on each front wheel. The drag link and tie rods each have a ball joint at both ends, a total of 6, **which** are subject to wear. If any of the rods are bent or incorrectly adjusted the wheel alignment will be upset causing incorrect handling and abnormal tyre wear. In the case of worn joints the wheels **will be** able to move independently of the steering gear. This will cause 'wander' and imprecise steering or, in extreme situations, wheel wobble.

Only 3 of the 6 ball joints are separately renewable and therefore they have to be adjustable. They are fitted to the r hand tie rod (left on RHD vehicles) and the front end of the c link. If any of the other joints wears out then the tie rod or t link as appropriate must be renewed as well.

2 Wear in the steering ball joints can be detected by observation. With the front wheels on the ground the steering wheel should be moved from side to side. Wherever there is any motion between two rods connected by a ball joint then the joint is worn out and must be renewed.

3 The ball joint pins are a taper fit into their locations and usually very tight. After removing the split pin and castle nut if you have no extractor tool, strike one side of the through which the pin goes whilst holding another hammer against the opposite side. This usually 'breaks' the taper.

4 When renewing a tie rod end that is adjustable mark the position carefully in relation to the tie rod before undoing clamp and screwing it out. This will help to ensure that the overall length of the tie rod is not altered and thus minimise upset of the wheel alignment. Note that one of the ball joints: the adjustable tie rod has a left hand thread. This one is normally fitted at the inside end. The same principle applies to the fit of the ball joint on the drag link (photo).

5 All the ball joints have grease retaining seals and these must be in good condition. It is possible to renew them if they slip and where the ball joint also has a removal plug fitted it is possible to put some more grease in to replace any that may have escaped (use Castrol MS3).

6 When fitting the new joint make sure that it is screwed in as near as possible to the position of the one removed. Also should line up with the joint at the other end of the tie rod. Then tighten the clamp.

7 When refitting the taper pin make sure that both surfaces of the taper are perfectly clean. If the threads for the nut do not 'run' easily clean them up, otherwise difficulty may be experienced because the pin rotates as the nut is tightened. If it happens anyway try levering another spanner or blade between the nut to draw the taper tight as the nut is screwed further. Tighten the nuts to the correct torque and move them on a little more if necessary to line up the split pin holes. Always use the split pins.

8 Wheel alignment must always be checked when steering joints are renewed. The adjustment on the tie rod so that the correct wheel toe can be set. The adjustment on the drag link to centre the steering gear when the wheels are straight ahead. These two adjustments are interdependent to some extent. Alignment is done quickly and accurately if carried out by a specialist agency with the proper optical alignment equipment.

### 16 Steering damper - removal, checking and replacement

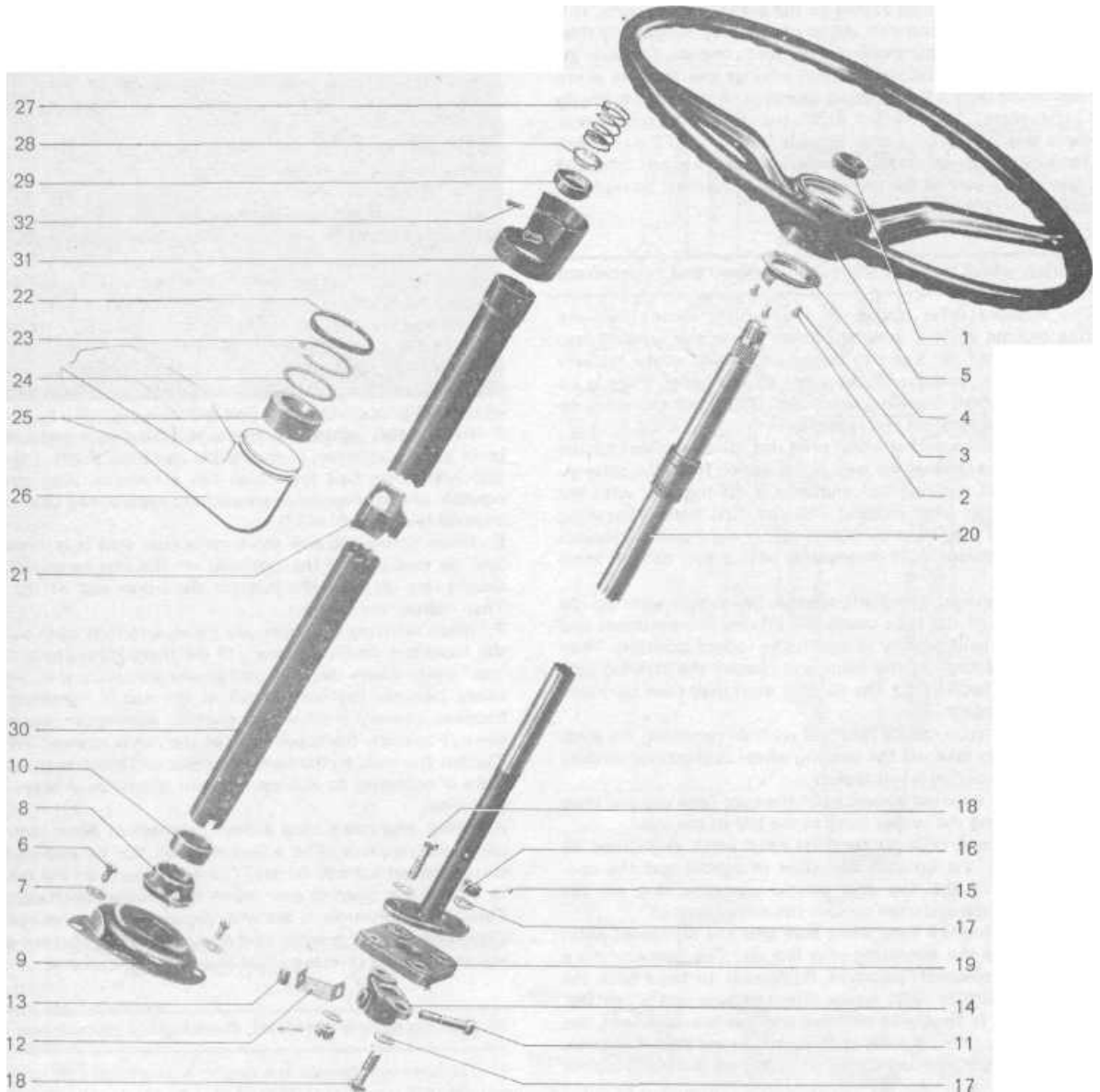
1 The steering damper is a double acting piston which serves to smooth out vibration and shocks through the steering. One end is fixed to the steering swing lever and the other to a bracket welded to the axle tube. Each fixing bolt is rubber bushed.

2 If the bushes are worn allowing play the damper should be removed and new bushes fitted. New bushes comprise a rubber buffer with a steel central sleeve. Old ones can be cut or drilled out and new ones pressed in between the jaws of a vice.

3 The bolts securing the ends of the damper are accessible from underneath for the tie-rod connection and from the luggage compartment for the frame head attachment. For the latter remove the spare wheel and prise out the small circular cover plate on the floor of the compartment.

4 If the damper is leaking fluid badly and there is inadequate action in either direction it should be renewed. To test the action of the damper push and pull the piston throughout its travel. There should be no roughness or variations in resistance anywhere along the travel of the piston. Note that damper units fitted to right hand drive vehicles are not the same as for those fitted to left hand drive.

5 Replace the damper (with the cylinder end mounted on



**FIG. 10.9 STEERING COLUMN ASSEMBLY (Sec 14)**

- |                         |                |                      |                                |
|-------------------------|----------------|----------------------|--------------------------------|
| 1 Nut                   | 9 Cap          | 17 Spring washer     | 25 Rubber bush                 |
| 2 Fillister head screw  | 10 Seal        | 18 Screw             | 26 Bracket                     |
| 3 Lock washer           | 11 Screw       | 19 Coupling disc     | 27 Spring                      |
| 4 Cancelling ring       | 12 Lock plate  | 20 Column shaft      | 28 Support ring                |
| 5 Steering wheel        | 13 Nut         | 21 Insulating ring   | 29 Bearing                     |
| 6 Cheese head screw     | 14 Flange      | 22 Insulating washer | 30 Column tube                 |
| 7 Spring washer         | 15 Cotter pin  | 23 Circlip           | 31 Turn signal switch retainer |
| 8 Plastic clamping ring | 16 Slotted nut | 24 Washer for bush   | 32 Fillister head screw        |

axle tube) by fitting the securing bolts and nuts and tightening them to the specified torques.

### 17 Front axle assembly - removal and replacement

- 1 If the front axle assembly is badly worn or damaged requiring a considerable amount of repair (or total replacement) it can be readily removed.
- 2 Disconnect the brake hoses at the brackets and plug the ends - use the bleeder valve dust caps if they are still there.
- 3 Disconnect the speedometer cable from the left front wheel bearing dust cover and pull it through from behind the steering knuckle.
- 4 Remove the cover plate under the foot pedal cluster underneath.
- 5 Engage 1st or 3rd gear so that the muff coupling and screw which join the front and rear gear change rods is accessible. The screw is locked with wire. Remove the screw and disengage and remove the front section.
- 6 From inside the driving compartment remove the gear change lever assembly (see Chapter 6).
- 7 Disconnect the clutch cable at the pedal end and the handbrake cables from the handbrake lever.
- 8 Disconnect the drag link from the swing lever in the steering linkage.
- 9 Remove the bolt securing the steering damper at the axle bracket end and turn it downwards.
- 10 Now raise vehicle and support it securely on stands at each side under the floor frame members. Raise it so that the wheels are just clear of the floor.
- 11 Support the front axle assembly under the lower tube with a trolley jack and remove the bolts holding the side plates to the frame side member, two bolts at each side.
- 12 The axle assembly may then be lowered and wheeled out.
- 13 Replacement is a reversal of the removal procedure bearing the following points in mind. Any gap between the side plates and side members should be taken up by packing pieces of suitable thickness. The four securing bolts on early models were fitted with two lockwashers. These were discontinued on later models and the bolts were shortened by 5 mm. The starter bolts may be used on earlier vehicles but if the larger bolts are used the lockwashers must also be fitted. When the axle is in position and before the bolts are tightened the assembly should be turned forward to take up any slack between the bolts and the holes. This prevents movement under braking forces. Then tighten the bolts to the correct torque.

### 18 Steering geometry and wheel alignment

- 1 The correct alignment of the front wheels does not normally alter and the need for checking and realigning occurs only after certain conditions, namely:
  - a) Renewal of track rod joints.
  - b) Damage to front suspension or steering linkage.
 Theoretically, if worn ball joints, wheel bearings and so on, are all renewed the steering geometry will automatically be correct. This, of course, presumes that no adjustment has been made in a misguided attempt to compensate for wear. If adjustments have been made then, of course, when the various parts are renewed the steering will have to be realigned.
- 2 The only adjustments which can be made are to the adjustable tie rod (wheel toe), the drag link (centering) and upper ball joint eccentric bush (camber). The alteration of camber automatically alters the king pin inclination at the same time.

King pin inclination is the old term for steering pivot angle and recalls the times when the steering pivoted on pins rather than ball joints.

3 *Adjustments* of steering geometry should never be made in a haphazard manner. In order to check all the angles correctly proper equipment is needed. Further more, it is quite pointless trying to realign the steering if one or more of the components is worn. A reputable garage would not normally undertake to re-adjust steering which had significant wear - although they may be prepared to inform you of the state of the alignment.

### 19 Wheels and tyres (to 1970)

1 To provide equal, and obtain maximum wear from all the tyres, they should be rotated on the vehicle at intervals of 6,000 miles to the following pattern:-

- Spare to right rear
- Right rear to left front
- Left front to left rear
- Left rear to right front
- Right front to spare.

Wheels should be re-balanced when this is done if they were balanced on the vehicle. However, some owners balk at the prospect of having to buy five new tyres all at once and tend to let two run on and replace a pair only. The new pair should always be fitted to the front wheels, as these are the most important from the safety aspect of steering and braking.

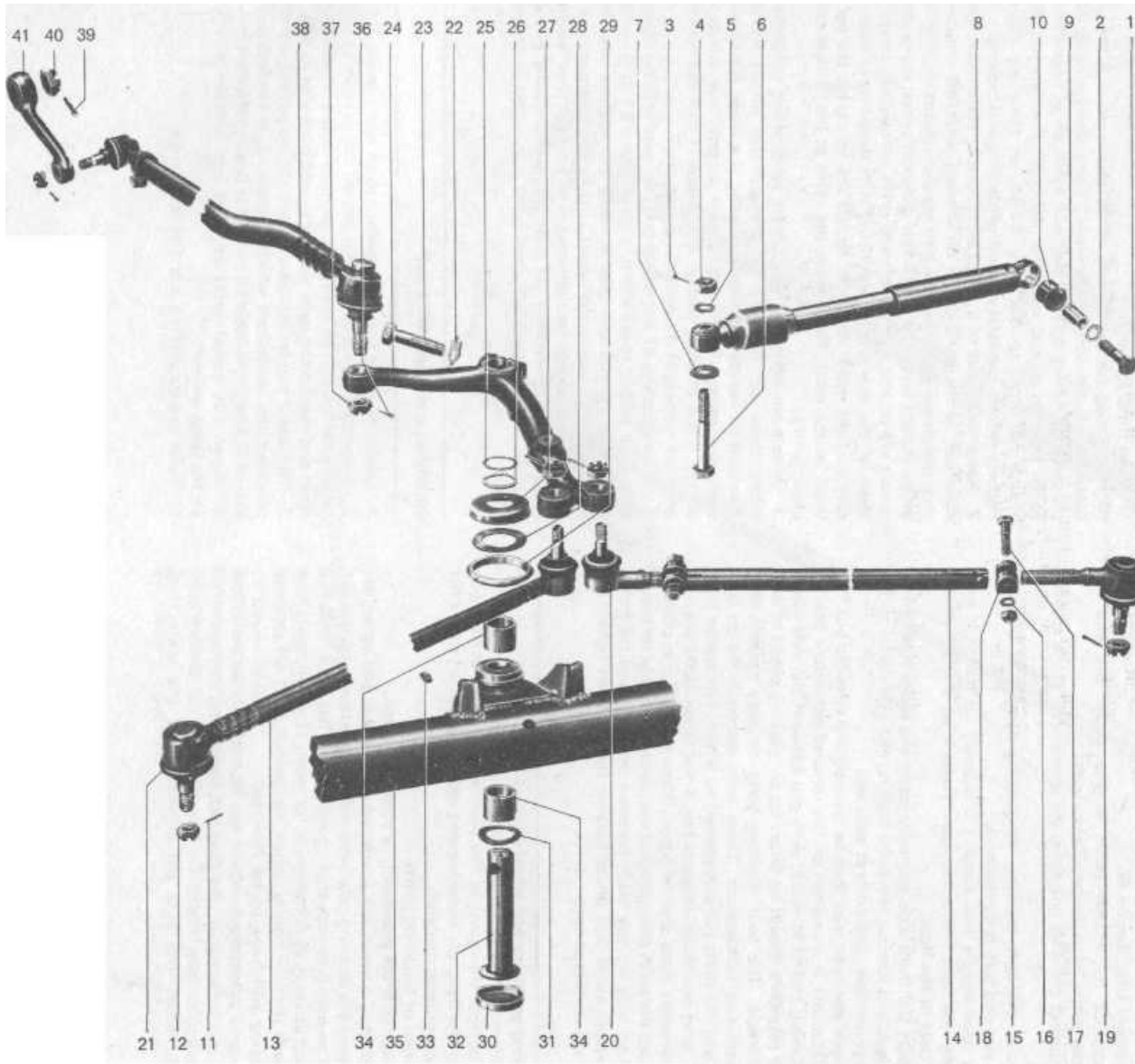
2 Never mix tyres of a radial and crossply construction on the same car, as the basic design differences can cause unusual and very dangerous handling and braking characteristics. If an emergency should force the use of two different types, make sure the radials are on the rear wheels and drive particularly carefully. If three of the five wheels are fitted with radial tyres then make sure that no more than two radials are in use on the car (and those at the rear). Rationalise the tyres at the earliest possible opportunity.

3 Wheels are normally not subject to servicing problems, but when tyres are renewed or changed the wheels should be balanced to reduce vibration and wear. If a wheel is suspected of damage - caused by hitting a kerb or pot hole which could distort it out of true, change it and have it checked for balance and true running at the earliest opportunity.

4 The tightening of the wheel bolts or nuts is to be done carefully. The torque requirement is quite high - 94 lb ft - which is just about all you can give it using the spanner and handle provided for changing the wheel in the event of a puncture. The bolts or nuts should be tightened evenly and if they have to be undone in an emergency get them checked properly as soon as possible. The tightness of wheel bolts is included in the service check.

### 20 Wheels and tyres (1971 on)

- 1 Radial tyres are fitted as standard to all later models.
- 2 Any wheel changing which is carried out in order to even out tread wear should be restricted to moving the wheels between front and rear on the same side only - *not* from side to side.
- 3 The spare can be introduced into the pattern of movement, provided the roadwheel which it replaces, is marked with the side of the car from which it came, for future reference.
- 4 Never mix radial tyres of steel and textile construction on the same vehicle.
- 5 Refer to paragraphs 3 and 4 of Section 19.



**FIG. 10.10 STEERING LINKAGE AND BALL JOINTS (Sec 15)**

- 1 Screw
- 2 Lock washer
- 3 Split pin
- 4 Nut
- 5 Spring washer
- 6 Screw
- 7 Washer
- 8 Steering damper
- 9 Sleeve
- 10 Bush
- 11 Split pin
- 12 Nut
- 13 Left tie rod
- 14 Right tie rod
- 15 Nut
- 16 Spring washer
- 17 Screw
- 18 Clip
- 19 Tie rod ball joint R.H.thread
- 20 Tie rod ball joint L.H. thread
- 21 Dust seal
- 22 Lock plate
- 23 Screw
- 24 Swing lever
- 25 Washer
- 26 Sealing ring
- 27 Cap
- 28 Thrust washer
- 29 Sealing ring
- 30 End cap
- 31 Spring washer
- 32 Swing lever shaft
- 33 Grease nipple
- 34 Bush
- 35 Lower axle tube
- 36 Split pin
- 37 Nut
- 38 Drag link
- 39 Split pin
- 40 Nut
- 41 Pitman (drop) arm



## 21 Fault diagnosis

Before diagnosing faults in the mechanics of the suspension and steering itself, check that any irregularities are not caused by:—

Binding brakes  
 Incorrect 'mix' of radial and cross-ply tyres  
 Incorrect tyre pressures  
 Misalignment of the bodyframe and suspension  
 due to accident damage

Symptom	Reason/s	Remedy
Steering wheel can be moved considerably before any sign of movement of the wheels is apparent	Wear in the steering linkage, gear and column coupling	Check movement in all joints and steering gear and adjust, overhaul and renew as required.
Vehicle difficult to steer in a consistent straight line - wandering	As above Wheel alignment incorrect (indicated by excessive or uneven tyre wear) Front wheel hub bearings loose or worn Worn suspension ball joints	As above Check wheel alignment. Adjust or renew as necessary. Renew as necessary.
Steering stiff and heavy	Incorrect wheel alignment (indicated by excessive or uneven tyre wear) Excessive wear or seizure in one or more of the joints in the steering linkage or suspension Excessive wear in the steering gear unit	Check wheel alignment. Repair as necessary. Adjust if possible , or renew.
Wheel wobble and vibration	Road wheels out of balance Road wheels buckled Wheel alignment incorrect Wear in the steering linkage or suspension	Balance wheels. Check for damage. Check wheel alignment. Check and renew as necessary
Excessive pitching and rolling on corners and during braking	Ineffective steering damper Defective dampers and/or broken torsion bar springs	Check and renew as necessary. Check and renew as necessary.

# Chapter 11 Bodywork and underframe

*For modifications, and information applicable to later models, see Supplement at end of manual*

## Contents

General description ... .. 1	Cab door window glass - removal and replacement ... 12
Maintenance - bodywork ... .. 2	Cab door quarter light - removal and replacement ... 13
Maintenance - upholstery and floor coverings ... .. 3	Cab door latch mechanism - removal and replacement ... 14
Minor body damage - repair ... .. 4	Cab door latch striker plate - adjustment ... 15
Major body repairs ... .. 5	Cab door lock cylinders - renewal ... 16
Front and rear bumpers - removal and replacement ... 6	Sliding door mechanism - description and adjustment ... 17
Windscreen and windows - removal and replacement ... 7	Sliding door - removal and repairs ... 18
Cab door rattles - tracing and recification ... .. 8	Front seats - removal and replacement ... 19
Cab doors - removal and replacement and hinge lubrication ... 9	Sliding roof - operation and adjustment ... 20
Cab door trim panels - removal and replacement ... .. 10	Pop up and hinged roofs - checking and maintenance ... 21
Cab door window lifter mechanism - removal and replacement ... .. 11	

## 1 General description

Although there are several models of body type the transporter range has the same basic structure for all diagrammatic layouts and seating plans as shown at the end of the chapter. The Van and Kombi models are the most basic. The Kombi is a van with windows and seats. The seats are readily removable to provide the same freight capacity as the van if necessary. Both models have either one or two sliding doors to the main load area behind the drivers compartment.

The Micro Bus is a vehicle permanently equipped as a passenger carrying vehicle having up to 12 seats. It is supplied in varying degrees of luxury with options such as sun roof.

The 'Campmobile' is the travelling home version fitted with an elevating roof and kitted out with most of the necessities of living; with tents and seats for external use included in some instances. These models are referred to as the Caravette - 2 to 4 berth or the Continental - 4 to 5 berth. The style of roof lift differs - one being telescopic and the other hinged at the front.

Various specialist coach building firms have produced other versions but the principles are much the same. In all those models with two sliding doors and where the roof panel is modified to provide an opening additional strengthening is provided in the floor frame.

The pick-up versions and the high roof van are almost exclusively for commercial applications. The load area of the pick-up is flat at the level of the top of the engine compartment and the locker space underneath is accessible through a side panel door. The fuel tank is also mounted in this under floor space.

The body is of unitary construction and is reinforced on the floor plates by a frame of side and cross members, (Fig.11.1).

The floor plates are welded to the reinforcing frame together with the seat box, wheel housings, cab rear panel and the jack brackets. The extra strengthening for those models requiring it is by means of additional plates in the centre section of the frame.

The front suspension assembly bolts to the side frame members which loop over it. The rear part of the frame bears the cross tube for the torsion bars of the rear suspension and the flanges to which the diagonal suspension arms are attached.

All models are treated with a wax based under seal which protects the body underneath. Exposed areas will need inspection about every 6 months as the protective coating will be abraded away by mud, stones and slurry. It does not last indefinitely.

## 2 Maintenance - bodywork and underframe

The general condition of the vehicle's bodywork is the one thing that significantly affects its value. Maintenance is easy but needs to be regular and particular. Neglect, particularly after minor damage, can lead quickly to further deterioration and

costly repair bills. It is important also to keep watch on those parts of the car not immediately visible, for instance the underside, inside all the wheel arches and the lower part of the engine compartment.

The basic maintenance routine for the bodywork is washing, preferably with a lot of water, from a hose. This will remove all the loose solids which may have stuck to the vehicle. It is important to flush these off in such a way as to prevent grit from scratching the finish. The wheel arches and underbody need washing in the same way to remove any accumulated mud which will retain moisture and tend to encourage rust. Paradoxically enough, the best time to clean the underbody and wheel arches is in wet weather when the mud is thoroughly wet and soft. In very wet weather the underbody is usually cleaned of large accumulations automatically and this is a good time for inspection.

Periodically, it is a good idea to have the whole of the underside of the vehicle steam cleaned, engine compartment included, so that a thorough inspection can be carried out to see what minor repairs and renovations are necessary. Steam cleaning is available at many garages and is necessary for the removal of the accumulation of oily grime which sometimes is allowed to cake thick in certain areas near the engine, gearbox and back axle. If steam facilities are not available, there are one or two excellent grease solvents available which can be brush applied. The dirt can then be simply hosed off.

After washing the paintwork, wipe off with a chamois leather to give an unspotted finish free from smears. A coat of clear protective wax polish will give added protection against chemical pollutants in the air. If the paintwork sheen has dulled or oxidised, use a cleaner/polisher combination to restore the brilliance of the shine. This requires a little effort, but is usually caused because regular washing has been neglected. Always check that the door and ventilator opening drain holes and pipes, are completely clear so that water can drain. Bright work should be treated in the same way as paintwork. Windscreens and windows can be kept clear of the smeary film which often appears, if a little ammonia is added to the water. If they are scratched, a good rub with a proprietary metal polish will often clear them. Never use any form of wax or other body or chromium polish on glass.

## 3 Maintenance - upholstery and floor coverings

1 Mats and carpets should be brushed or vacuum cleaned regularly to keep them free of grit. If they are badly stained remove them for scrubbing or sponging and make quite sure they are dry before replacement. Seats and interior trim panels can be kept clean by a wipe over with a damp cloth. If they do become stained (which can be more apparent on light coloured upholstery) use a little liquid detergent and a soft nailbrush to scour the grime out of the grain of the material. Do not forget to keep

the head lining clean in the same way as the upholstery. When using liquid cleaners inside the car do not over-wet the surfaces being cleaned. Excessive damp could get into the seams and padded interior causing stains, offensive odours or even rot. If the inside of the car gets wet accidentally, it is worthwhile taking some trouble to dry it out properly, particularly where carpets are involved. Do NOT leave heaters inside for this purpose.

#### 4 Minor body damage - repair

##### *Repair of minor scratches in the vehicle's bodywork*

If the scratch is very superficial, and does not penetrate to the metal of the bodywork, repair is very simple. Lightly rub the area of the scratch with a paintwork renovator, or a very fine cutting paste, to remove loose paint from the scratch and to clear the surrounding bodywork of wax polish. Rinse the area with clean water.

Apply touch-up paint to the scratch using a thin paint brush; continue to apply thin layers of paint until the surface of the paint in the scratch is level with the surrounding paintwork. Allow the new paint at least two weeks to harden, then blend it into the surrounding paintwork by rubbing the scratch area, with a paintwork renovator or a very fine cutting paste. Finally, apply wax polish.

Where the scratch has penetrated right through to the metal of the bodywork, causing the metal to rust, a different repair technique is required. Remove any loose rust from the bottom of the scratch with a penknife, then apply rust inhibitor paint to prevent the formation of rust in the future. Using an applicator, fill the scratch with bodystopper paste. If required, this paste can be mixed with a cellulose thinner to provide a very thin paste which is ideal for filling narrow scratches. Before the stopper-paste in the scratch hardens wrap a piece of smooth cotton rag around the top of a finger. Dip the finger in cellulose thinners and then quickly sweep it across the surface of the stopper-paste in the scratch: this will ensure that the surface of the stopper-paste is slightly hollowed. The scratch can now be painted over as described earlier in this Section.

##### *Repair of dents in the vehicle's bodywork*

When deep denting of the vehicle's bodywork has taken place, the first task is to pull the dent out until the affected bodywork almost attains its original shape. There is little point in trying to restore the original shape completely as the metal in the damaged area will have stretched on impact and cannot be reshaped fully to its original contour. It is better to bring the level of the dent up to a point which is about 1/8 in (3 mm) below the level of the surrounding bodywork. In cases where the dent is very shallow anyway, it is not worth trying to pull it out at all.

If the underside of the dent is accessible, it can be hammered out gently from behind, using a mallet with a wooden or plastic head. Whilst doing this, hold a suitable block of wood firmly against the impact from the hammer blows to prevent a large area of the bodywork from being 'belled-out'.

Should the dent be in a section of the bodywork which has double skin or some other factor making it inaccessible from behind, a different technique is called for. Drill several small holes through the metal inside the area particularly in the deeper section. Then screw long self-tapping screws into the holes just sufficiently for them to gain a good purchase in the metal. Now the dent can be pulled out by pulling on the protruding heads of the screws with a pair of pliers.

The next stage of the repair is the removal of the paint from the damaged area, and from an inch or so of the surrounding undamaged bodywork. This is accomplished most easily by using a wire brush or abrasive pad on a power drill, although it can be done just as effectively by hand using sheets of abrasive paper.

To complete the preparation for filling, score the surface of the bare metal with a screwdriver or the tang of a file; alternatively, drill small holes in the affected area. This will provide a really good 'key' for the filler paste.

To complete the repair see the Section on filling and re-spraying.

##### *Repair of rust holes or gashes in the vehicle's bodywork*

Remove all paint from the affected area and from an inch or so of the surrounding undamaged bodywork, using an abrasive pad or a wire brush on a power drill. If these are not available, a few sheets of abrasive paper will do the job just as effectively. With the paint removed you will be able to gauge the severity of the corrosion and therefore decide whether to renew the whole panel (if this is possible) or to repair the affected area. New body panels are not as expensive as most people think and it is often quicker and more satisfactory to fit a new panel than to attempt to repair large areas of corrosion.

Remove all fittings from the affected area except those which will act as a guide to the original shape of the damaged bodywork (eg headlamp shells etc). Then, using tin snips or a hacksaw blade, remove all loose metal and any other metal badly affected by corrosion. Hammer the edges of the hole inwards in order to create a slight depression for the filler paste.

Wire brush the affected area to remove the powdery rust from the surface of the remaining metal. Paint the affected area with rust inhibiting paint; if the back of the rusted area is accessible treat this also.

Before filling can take place it will be necessary to block the hole in some way. This can be achieved by the use of zinc gauze or aluminium tape.

Zinc gauze is probably the best material to use for a large hole. Cut a piece to the appropriate size and shape of the hole to be filled, then position it in the hole so that its edges are below the level of the surrounding bodywork. It can be retained in position by several blobs of filler paste around its periphery.

Aluminium tape should be used for small or very narrow holes. Pull a piece off the roll and trim it to the approximate size and shape required, then pull off the backing paper (if used). Stick the tape over the hole, overlapping if the thickness of one piece is insufficient. Burnish down the edges of the tape with the handle of a screwdriver or similar, to ensure that the tape is securely attached to the metal underneath.

##### *Bodywork repairs - filling and respraying*

Before using this Section, see the Sections on dent, deep scratch, rust holes and gash repairs.

Many types of bodyfiller are available, but generally speaking those proprietary kits which contain a tin of filler paste and a tube of resin hardener are best for this type of repair. A wide, flexible plastic or nylon applicator will be found invaluable for imparting a smooth and well contoured finish to the surface of the filler.

Mix up a little filler on a clean piece of card or board. Use the hardener sparingly, following the maker's instructions on the packet, otherwise the filler will set very rapidly.

Using the applicator, apply the filler paste to the prepared area. Draw the applicator across the surface of the filler to achieve the correct contour and to level the filler surface. As soon as a contour that approximates the correct one is achieved, stop working the paste. If you carry on too long the paste will become sticky and begin to 'pick up' on the applicator. Continue to add thin layers of filler paste at twenty-minute intervals until the level of the filler is just proud of the surrounding bodywork.

Once the filler has hardened, excess can be removed using a plane or file. From then on, progressively finer grades of abrasive paper should be used, starting with a 40 grade production paper and finishing with 400 grade wet-and-dry paper. Always wrap the abrasive paper around a flat rubber, cork, or wooden block, otherwise the surface of the filler will not be completely flat. During the smoothing of the filler surface the wet-and-dry paper should be periodically rinsed in water. This

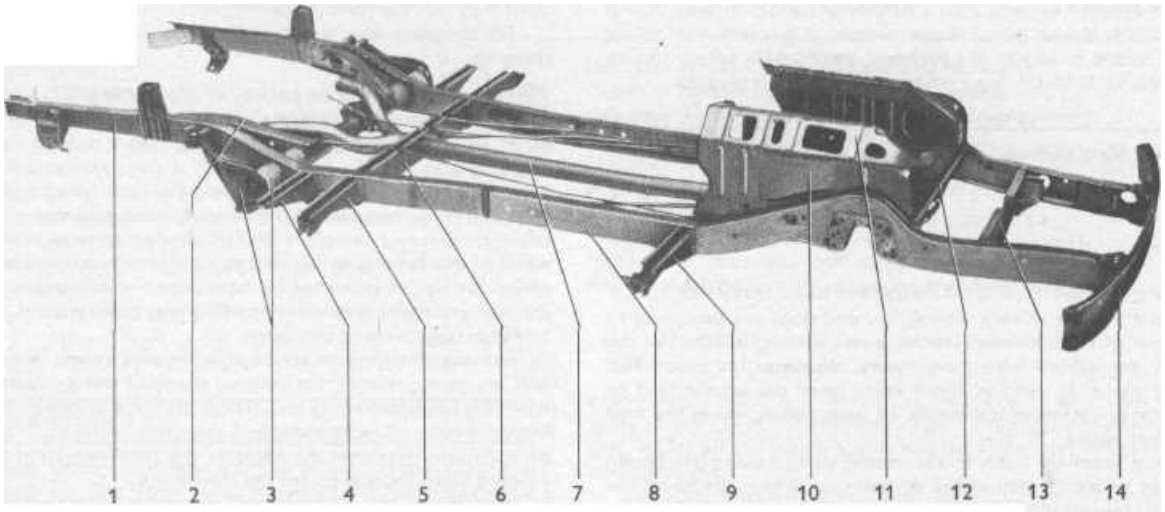


FIG.11.1 FLOOR FRAME

- |                            |                        |                           |                        |
|----------------------------|------------------------|---------------------------|------------------------|
| 1 Side member, rear        | 5 Outrigger, centre    | 9 Outrigger, front        | member inserts         |
| 2 Side member insert, rear | 6 Support, rear member | 10 Side member insert     | 13 Cross member, front |
| 3 Cross tube with flange   | 7 Heater tube          | 11 Seat box               | 14 Front cross support |
| 4 Outrigger, rear          | 8 Side member, front   | 12 Stiffener between side |                        |

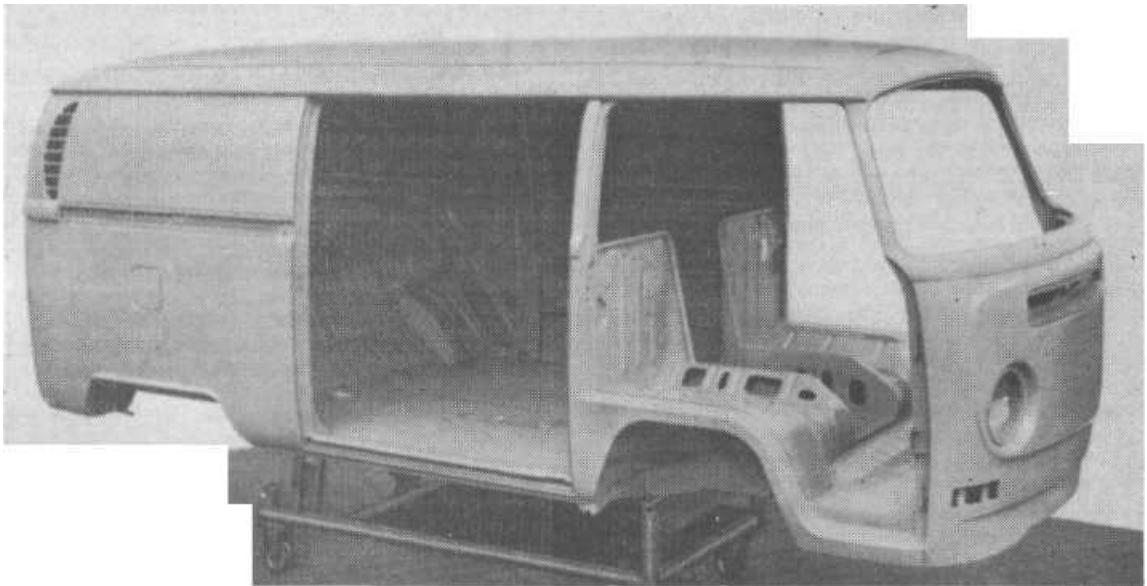


FIG.11.2 BODY SHELL

will ensure that a very smooth finish is imparted to the filler at the final stage.

At this stage the dent should be surrounded by a ring of bare metal, which in turn should be encircled by the finely 'feathered' edge of the good paintwork. Rinse the repair area with clean water, until all of the dust produced by the rubbing-down operation has gone.

Spray the whole repair area with a light coat of primer to show up any imperfections in the surface of the filler. Repair these imperfections with fresh filler paste or bodystopper, and once more smooth the surface with abrasive paper. If bodystopper is used, it *can be mixed with cellulose* thinners to form a really thin paste which is ideal for filling small holes. Repeat this spray and repair procedure until you are satisfied that the surface of the filler and the feathered edge of the paintwork are perfect. Clean the repair area with clean water and allow to dry fully.

The repair area is now ready for final spraying. Paint spraying must be carried out in a warm, dry, windless and dust free atmosphere. This condition can be created artificially if you have access to a large indoor working area, but if you are forced to work in the open, you will have to pick your day very carefully. If you are working indoors, dousing the floor in the work area with water will help to settle the dust which would otherwise be in the atmosphere. If the repair area is confined to one body panel, mask off the surrounding panels; this will help to minimise the effects of a slight mis-match in paint colours. Bodywork fittings (eg chrome strips, door handles etc) will also need to be removed or masked off. Use genuine masking tape and several thicknesses of newspaper for the masking operations.

Before commencing to spray, agitate the aerosol can thoroughly, then spray a test area (an old tin, or similar) until the technique is mastered. Cover the repair area with a thick coat of primer; the thickness should be built up using several thin layers of paint rather than one thick layer. Using 400 grade wet-and-dry paper, rub down the surface of the primer until it is really smooth. While doing this, the work area should be thoroughly doused with water, and the wet-and-dry paper periodically rinsed in water. Allow to dry before spraying on more paint.

Spray on the top coat, again building up the thickness by using several thin layers of paint. Start spraying in the centre of the *repair* area and then using a circular motion, work outwards until the whole repair area and about 2 inches of the surrounding original paintwork is covered. Remove all masking material 10 to 15 minutes after spraying on the final coat of paint.

Allow the new paint at least two weeks to harden, then, using a paintwork renovator or a very fine cutting paste, blend the edges of the paint into the existing paintwork. Finally, apply wax polish.

## 5 Major body repairs

1 Where serious damage has occurred or large areas need renewal due to neglect it means certainly that completely new sections or panels will need welding in and this is best left to professionals. If the damage is due to impact it will also be necessary to check the alignment of the body structure. In such instances the services of a Volkswagen agent with specialist checking jigs are essential. If a body is left misaligned it is first of all dangerous as the car will not handle properly - and secondly, uneven stresses will be imposed on the steering, engine and transmission, causing abnormal wear or complete failure. Tyre wear will also be excessive.

## 6 Front and rear bumpers - removal and replacement

1 The front bumper is held by two brackets bolted to the ends of the side frame members (Fig.11.1). The bolts are accessible from underneath. In addition two bolts at each side hold the

ends of the bumper by integral brackets to the body. This makes the whole bumper rigid.

2 The rear bumper is secured by brackets in the same manner very close to the engine mounting brackets. These bolts are also accessible from underneath. Again the bumper is held to the curve of the body panels at the outer edge. Access to these is inside the wing panel which will need cleaning out first in all probability. The upper bolt fastens into a captive nut in the bumper. The lower one is a smaller nut and bolt which sometimes gets rusty and may have to be cut off.

## 7 Windscreen and windows - removal and replacement

1 The Transporter windscreen is a large, heavy and expensive article. If you are unfortunate enough to have to obtain a new one you would be well advised to let the supplier fit it. If you acquire one removed from a wrecked vehicle you will still be paying a reasonably high price for it. Unless you are experienced and have competent assistance it is recommended that it be professionally fitted. Other fixed windows are similarly fitted and the procedure is the same.

First loosen the rubber sealing strip on the inside where it fits over the edge of the window frame. Use a piece of wood for this. Anything sharp may rip the rubber weatherstrip. The glass can be pushed out, weatherstrip attached, if pressure is applied at the top corners. Two people are needed on this to prevent the glass falling out. Push evenly and protect your hands to avoid accidents. Remove the finisher strip from the weatherstrip.

2 When fitting glass first make sure that the window frame edges are even and smooth. Examine the edges of the glass to see that it is ground smooth and no chips or cracks are visible. Any such cracks could be the start of a much bigger one. The rubber weatherstrip should be perfectly clean. No traces of sealing compound should remain on rubber, glass or metal. If the sealing strip is old, brittle, or hard, it is advisable to fit a new one even though they are not cheap.

3 Fit the weatherstrip to the glass first so that the joint comes midway along the top edge.

4 Next fit any decorative moulding into the weatherstrip. This is done by first feeding fine cord into the slot (use a piece of thin tubing as a guide and time saver) and leave the ends overlapping long enough to be able to grip later. The two halves of the moulding are then put in place and the cord drawn out so that the edge of the strip locks them into place.

5 Apply suitable sealing compound to the weatherstrip where it will seat onto the metal window frame and also onto the outside faces of the frame at the lower corners.

6 Fit a piece of really strong thin cord into the frame channel of the weatherstrip as already described and then offer up the glass to the aperture. This operation requires two people.

7 When you are sure that the glass is centrally positioned, pull the cord out so that the lip of the weatherstrip is drawn over the inner edge of the frame flange. One of the most frequent difficulties in this job is that the cord breaks. This is often because of sharp or uneven edges on the frame flange so a little extra time in preparation will pay off.

## 8 Cab door rattles - tracing and rectification

Oor rattles are due either to loose hinges, worn or mal-adjusted catches, or loose components inside the door. Loose hinges can be detected by opening the door and trying to lift it. Any play will be felt. Worn or badly adjusted catches can be found by pushing and pulling on the outside handle when the door is closed. Once again any play will be felt. To check the window mechanism open the door and shake it with the window first open and then closed. Rattles will normally be heard.

## 9 Cab doors - removal, replacement and hinge lubrication

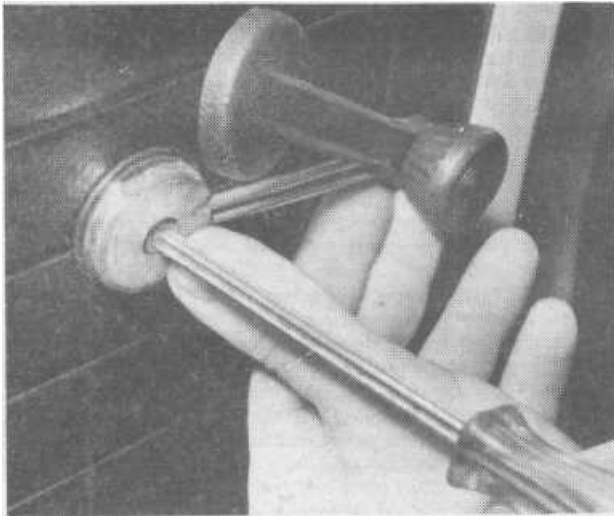
1 The door hinges are welded to the door and fixed to the



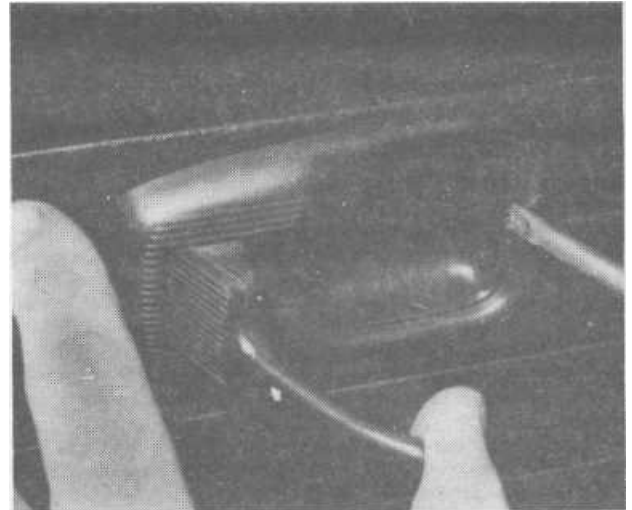
9.4a Check strap lubrication



9.4b Door hinge lubrication



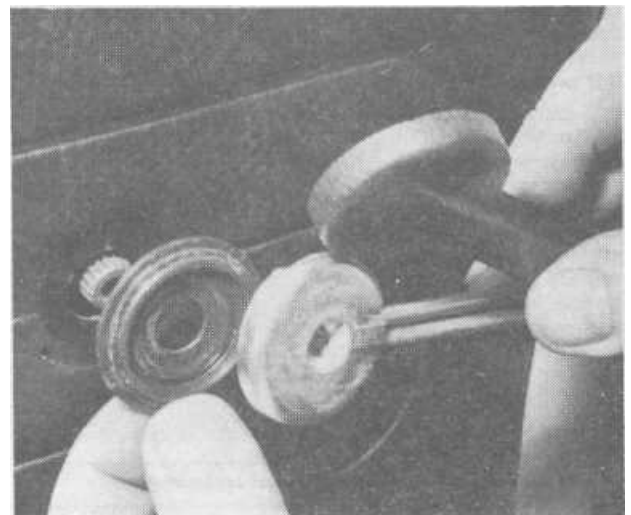
10.1a Remove the window winder handle



10.1 b Prise out the door latch finger plate



10.1c Remove the escutcheon retaining screw



10.3 Do not forget the rubbing washer behind the window winder handle

vehicle by four countersunk crosshead screws. There is also a door check strap which is held by a pin. The pin can be taken out after retaining clip is taken off its lower end.

2 To slacken the hinge screws an impact screwdriver is essential. Similarly for tightening them properly on replacement.

3 When hanging a new door (or re-aligning one which is out of position) insert all hinge screws loosely and then tighten just one in each hinge sufficiently to hold the door whilst it is set centrally and flush in the opening. It makes things easier if you remove the latch striker plate whilst this is being done.

4 The hinges are lubricated by prising out the sealing plug at the top and putting in a few drops of light oil (photos).

#### 10 Cab door trim panols - removal and replacement

1 First remove the window winder, door latch lever and door pull strap. The winder handle has a plastic cover which should be prised off at the spindle end. A crosshead screw is then accessible and should be removed (photo). The recessed finger plate behind the inner door handle lever can be prised out also with a screwdriver (photo). The crosshead screw behind it can then be removed to release the assembly (photo). Then use a piece of the trim panel itself.

2 Replacement is a reversal of the removal procedure.

3 Remember the rubbing washer behind the window winder handle (photo).

#### 11 Cab door window lifter mechanism - removal and replacement

1 The cable type window lifter is attached to the door at four places. If it is defective in any way the whole assembly will need to be replaced.

2 Remove the door trim panel and take off the PVC sheet.

3 Take out one screw holding the upper end of the front window guide channel, and then undo and remove the two screws holding the window lifter channel to the lifter mechanism. Push the window up and make sure it is jammed in position.

4 Remove the six screws holding the complete assembly to the door panel and unclip the bottom end of the transparent plastic cable tube from the door.

5 Press the front window guide channel of its bracket and then take the whole assembly out of the door.

6 When refitting, which is done in the reverse order first make sure that the mechanism works freely and that the cable does not rattle in any of the tubes. The tubes may be squeezed a little to prevent this if necessary. See that the foam strips at the top of the lifter are secure.

When the lifter mechanism is once more fixed to the door attach the window lifter plate and run the window up and down several times before finally tightening the front window channel screw and the two lifter channel screws.

#### 12 Cab door window glass - removal and replacement

1 Before the glass can be removed the lifter mechanism must be taken out as described in the previous section. In addition the screw holding the window rear guide channel must be undone and the channel pushed to one side. The window may then be lowered and taken out of the bottom of the door.

2 If the lifter channel is separated from the glass it should be refitted so that the centre hole is equidistant from the front and rear edge of the glass.

#### 13 Cab door quarter light - removal and replacement

1 To remove glass grind off the bottom of the rivet at the top pivot and punch the rest out. (It is too hard to drill). The glass can then be tilted out and lifted out of the bottom clamp.

2 It is important to renew the upper pivot rivet with the proper hardened type suitably spread. The security of the vehicle may depend on it.

3 If the glass pivots too freely or too stiffly then it is possible to alter the friction on the bottom pivot clamp. Remove the door inner trim panel (Section 10) and the clamp screw is accessible through a hole in the door panel.

#### 14 Cab door latch mechanism - removal and replacement

1 Remove the door trim panel (Section 10) and wind the window up. The rear guide channel is removed by taking out the bolt at the bottom and disengaging the clip at the top.

2 Undo the two screws holding the interior latch release lever to the door panel. Then unhook the pull rod at both ends and take it out.

3 Remove the two hexagon socket head cap screws holding the door handle to the panel and take the handle off.

4 Unscrew the locking button from the locking rod and then unhook the rod spring from the lock and take out the pull rod.

5 Put the latch in a vertical position, undo the 3 Phillips screws holding the latch mechanism to the inner panel and then take it out downwards complete with its plastic cover.

6 Replacement is the reverse of this procedure except that the locking rod should be attached to the lock before it is put up in position. When refitting the rear window guide channel difficulty may be experienced in refastening the top clip. This can be seen if the run channel is raised a little in the window slot at the top with the window in the raised position. Make sure the top run channel is firmly engaged afterwards.

#### 15 Cab door latch striker plate - adjustment

1 If the door latch striker plate is the cause of rattles first check that it is not worn out. This can be done by taking it off completely and fitting it over the latch hook with the latch in the vertical position.

There should be no up and down movement between the two. If the rubber wedge is obviously worn renew it. Otherwise it is possible to put some packing under the wedge to reduce the clearance to zero.

2 Check that the door fits the aperture properly by seeing that the gaps are more or less equal all round and that it fits flush with the side panel of the bodywork. There should be no rubbing and all the weatherstrip should show signs of equal compression.

3 Refit the striker plate leaving the screws just tight enough to hold it in position.

4 If the door will shut and latch only when slammed it means that the rubber wedge at the top of the striker plate is too far out thus preventing the corresponding wedge on the door from moving right in. If the door can be rattled in and out when latched the wedge on the striker plate is too far in. To remedy either of these conditions move the upper end of the striker plate in or out as necessary (see Fig.11.3).

#### 16 Cab door lock cylinders - renewal

1 The fitting of new lock cylinders is a relatively simple task, particularly on later models. Remove the complete door handle first by taking off the inner door trim panel and undoing the two hexagon socket cap screws that hold it to the door panel.

2 Remove the Philips screw holding the operating pin and take off the pin followed by the spring. On early models remove the circlip inside the handle and take out the lock cylinder housing with care otherwise the spring and locating ring may fly out. Remove the seal and 'O' ring from the housing, undo the set-screw and take the lock cylinder out of the housing (Fig.11.4). On later models the cylinder housing is incorporated in the handle simplifying the assembly (Fig.11.5). Reassembly is a reversal of this procedure.



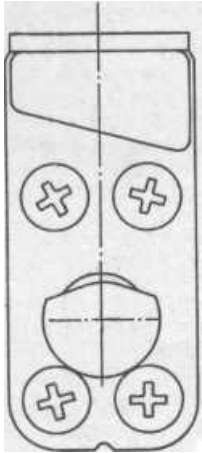


FIG. 11.3 DOOR LATCH STRIKER PLATE (Sec 15)

*Slackening of screws enables plate to be moved in any direction*

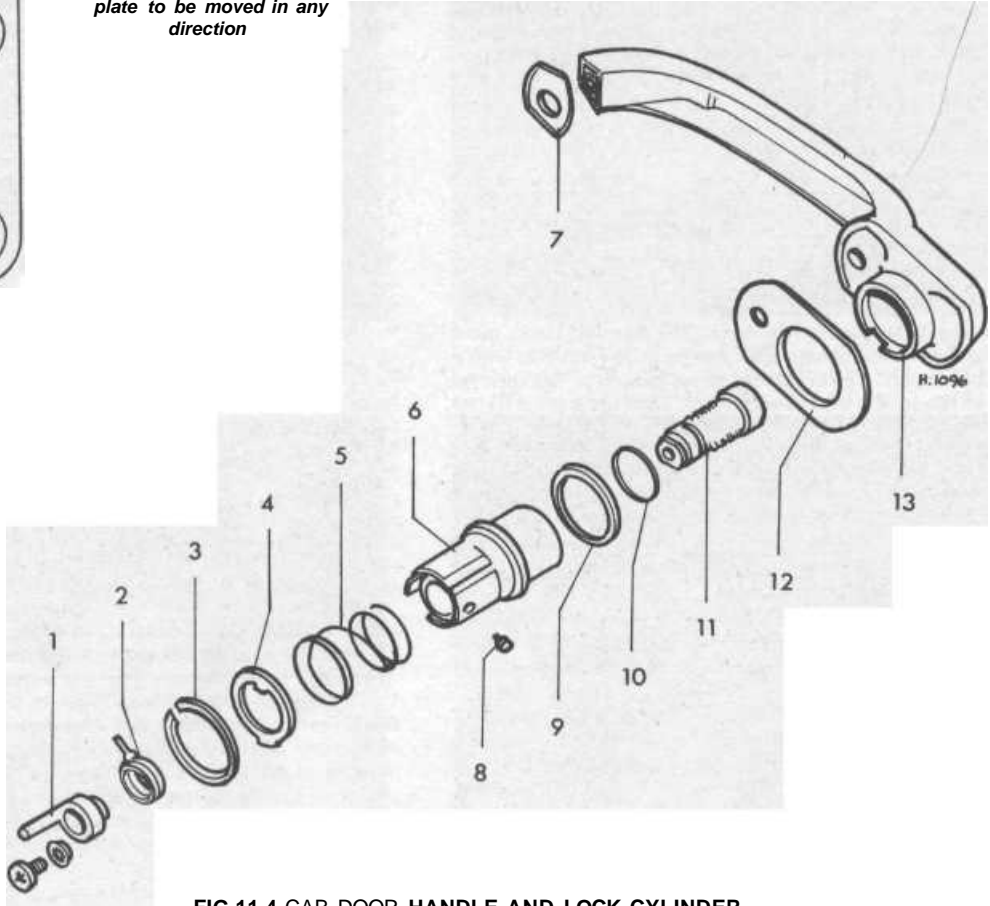


FIG.11.4 CAB DOOR HANDLE AND LOCK CYLINDER - EARLY MODELS (Sec 16)

- 1 Operating pin
- 2 Rotary spring
- 3 Circlip
- 4 Locating ring

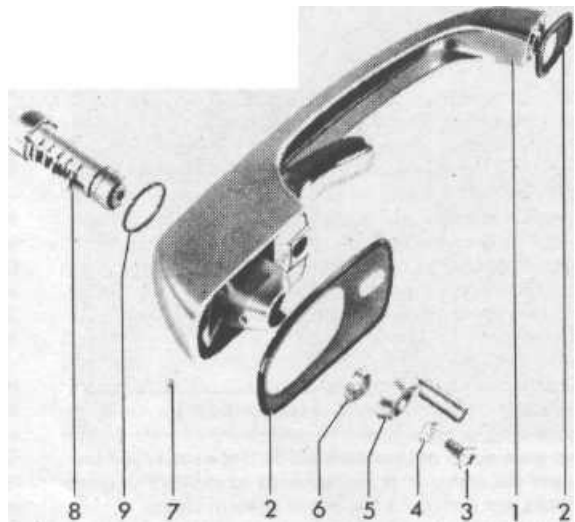
- 5 Spring
- 6 Lock cylinder housing
- 7 Casket

- 8 Setscrew
- 9 Seal
- 10 O • ring

- 11 Lock cylinder
- 12 Gasket
- 13 Door handle

FIG.11.5 CAB DOOR HANDLE AND LOCK CYLINDER LATER MODELS (Sec 16)

- 1 Door handle
- 2 Gasket
- 3 Phillips screw
- 4 Lockwasher
- 5 Operating pin
- 6 Spring
- 7 Setscrew
- 8 Lock cylinder
- 9 O-ring



## 17 Sliding door mechanism - description and adjustment

1 The sliding door runs in three channels. At the bottom, a roller bracket fitted at the front corner supports weight and guides the door in a channel fitted along the bottom of the door opening. In the centre a roller bracket combined with a throw-out hinge is fitted on the rear edge and thus takes weight and runs in a channel fitted to the outside of the vehicle under a cover. At the top edge a bracket with a guide roller runs in a channel along the top edge of the door opening. The door slides back on the outside of the body work. The rear runner hinge bracket throws the rear edge of the door out and once the front edge of the door is clear of the front latch the top and bottom channels guide the front of the door outwards, thus enabling it to slide back parallel with the body.

There are three latch devices. At the front there is a remote control lock to which the operating handles are attached. From this latch connecting rods run to the rear centre lock. When the operating handle is moved upwards the rear latch engages. When the handle is moved down the rear latch disengages, and the spring loaded hinge bracket moves the rear edge of the door outwards. Further downward movement of the handle disengages the front latch and the door may then be pushed back. A retainer catch mounted above the remote control latch engages with a pin on the rear buffer bracket mounted at the front end of the central runner. This prevents the door from sliding shut under its own weight on forward slopes. A connecting lever from the remote control latch releases the retainer catch when the door is to be closed.

2a Adjustments are necessary if the door does not run freely or does not line up in the body aperture. When closed the gap should be equal around the edges of the door. The door should also line up flush with the body panels.

2b To adjust the vertical position of the door the lower roller is moved. It is secured by a cross head screw on the door front face and two socket head cap screws underneath. If the door needs raising, then additional shims will be needed between the horizontal part of the mounting and the door. If the door is not flush with the body panels it can be moved in or out in relation to the roller bracket (Fig.11.6).

2c If the top of the door is not flush the roller may be moved on its bracket as necessary. The top roller should also be as high up into the track as possible without binding. This can be adjusted on the bracket which has slotted holes for vertical adjustment (Fig.11.7).

2d The gap at the front and rear vertical edges is adjusted by moving the hinge link. Slacken the four bolts holding it to the door (when the door is shut) and move the door forward or backward as required (Fig.11.8).

2e The door retainer should line up with the locking pin on the buffer bracket and can be moved up and down when the three retaining screws are slackened (Fig.11.12).

2f The proper engagement of the remote control lock into the locking plate is dependent on the fore and aft adjustment of the door by the hinge link already mentioned. This plate can be adjusted vertically as required to accept the tongue of the latch (Fig.11.9).

2g The rear of the door, when closed, should not move when pressed from outside near the hinge link. If it does move, or conversely, if the engagement of the centre latch seems to require excessive force on the handle, the striker plate needs adjustment. Slacken the two securing screws and move it up, down, in or out as required (Fig.11.10).

2h The two connecting rods between the remote control lock and the centre lock are adjustable. First remove the door trim panel and slacken the connecting rod screwed sleeves at the front end. The front latch has one hole drilled into the casing and the rear latch has two. They are 4 mm in diameter and enable screws to be put in which will hold the connecting rod levers in position. If you have no 4 mm screws use drills, nails or punches of a convenient diameter (Fig.11.11).

Screw up the connecting rod sleeves until the rods are tight and then tighten the locknut. There should be a foam pad stuck to the door panel near the centre of the rods to prevent them rattling. Latch operation is correct when the outer door handle end has to be pulled down at least 40 mm from the horizontal to release the front latch. On later models one lower rod is replaced by a Bowden cable. The lock pin hole is discontinued in the front latch and the rear latch cover has one only. The Bowden cable is adjusted first, taking care not to tighten it so that the front latch mechanism moves. The connecting rod should then be adjusted.

## 18 Sliding door - removal and repairs

1 If either of the two latches has to be taken off, the inner door trim panel must be removed. The door retainer catch can be removed without disturbing the trim. Simply remove the screws and take it out of the connecting rod (Fig.11.13).

2 To remove any of the rollers or hinge link it is necessary to remove the door. To do this, the cover over the centre runner must first be removed. It consists of a beading strip, cover and retaining strip (Fig.11.14). On early models three screws hold the cover to the body, two at the front and one at the rear.

3 Remove these and then open the door to get at the retaining strip tensioning screw which is accessible in the open end at the front of the cover (Fig. 11.15). Unscrew this about 15 turns and then strike it smartly with a suitable drift to push the retaining strip back. Then lift the cover up and out.

4 Move the door back until the guide piece and roller on the hinge link can be disengaged from the channel. Then push the door all the way back until the upper roller clears the top channel. Then swing the rear of the door out a little so that the lower rollers can be moved out of the gap in the bottom channel.

5 The roller brackets and hinge link assembly are all readily taken off the door by removing the securing screws and bolt. Any worn idlers or pins should be replaced with new ones. The hinge link assembly may be dismantled for parts replacement (Fig.11.16). All pins and moving hinge parts should be kept lightly oiled and the rollers smeared with universal grease.

## 19 Front seats - removal and replacement

1 The drivers seat is removed by lifting the fore and aft adjusting lever and sliding it forward out of its runners.

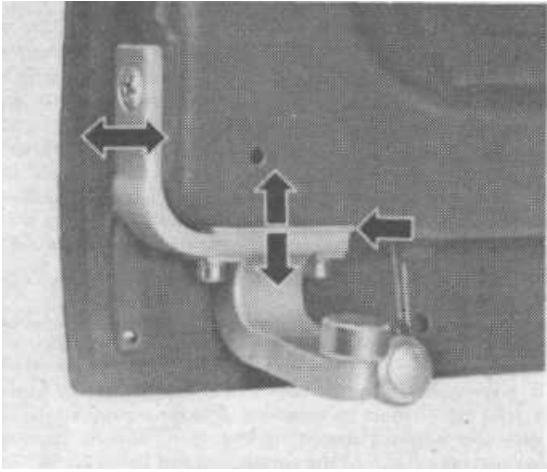
2 To remove the front passengers seat lift up the front of the squab. This draws the back rest downwards so that it disengages from a retainer loop behind. The seat and back rest together are then lifted out. The retainer loop behind the backrest is adjustable to make the seat secure properly.

## 20 Sliding roof - operation and adjustment

1 The movement of the sliding roof is controlled by special flexible cables, a sort of flexible rack, which engage with a pinion drive gear revolved by a crank handle.

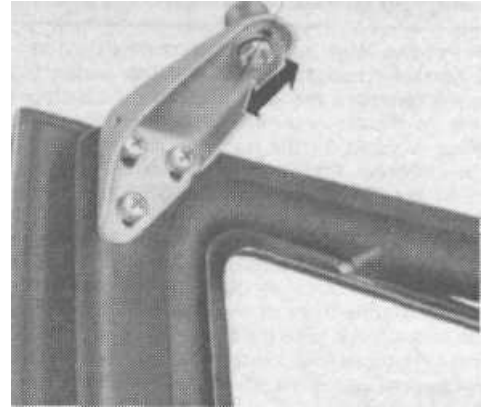
2 Any tendency for the sliding roof to jam must be investigated without delay otherwise damage or excessive wear of the components may result. Generally speaking adjustments are confined to ensuring that it runs parallel and is maintained at the correct height.

3 To adjust the roof to ensure that it slides parallel first unclip the front edge of the trim panel with the roof open a little way. Then push the trim panel as far back as it will go (it is not possible to remove the trim panel without taking the roof off completely). Close the roof again. Remove the crank handle retaining screw and pull off the handle and escutcheon. Then slacken the drive gear retaining screws 6 turns so that the gear can be drawn down far enough to disengage from the cables (Fig.11.19).



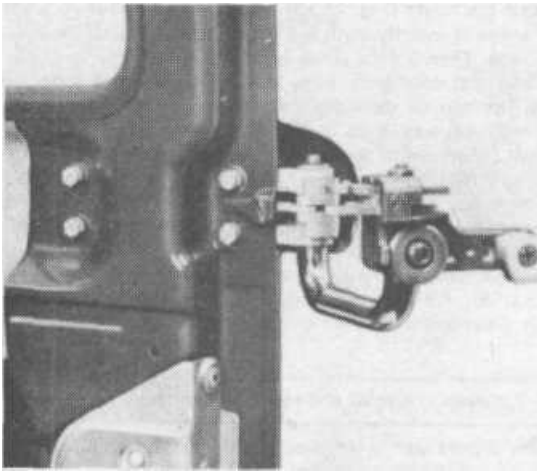
**FIG.11.6 SLIDING DOOR-LOWER ROLLERS AND BRACKET (Sec 17)**

*Arrows indicate movement and shims*

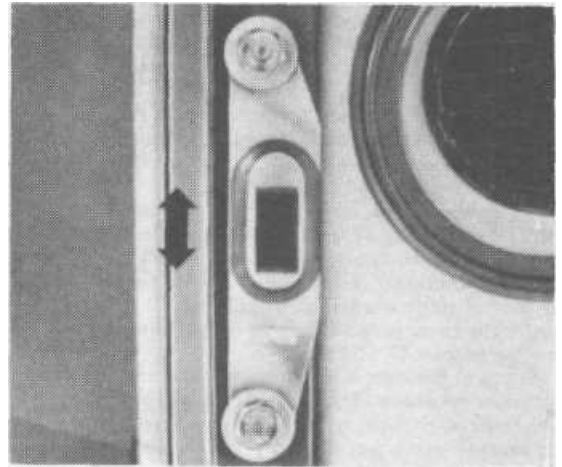


**FIG.11.7 SLIDING DOOR - TOP GUIDE ROLLER AND BRACKET (Sec 17)**

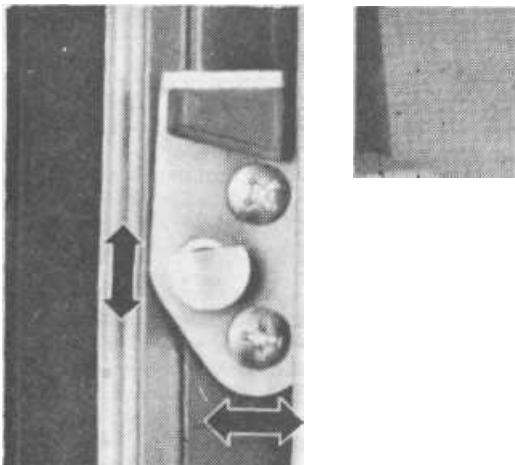
*Arrow indicates roller movement for door position adjustment. Bracket screws are loosened to move roller into channel recess.*



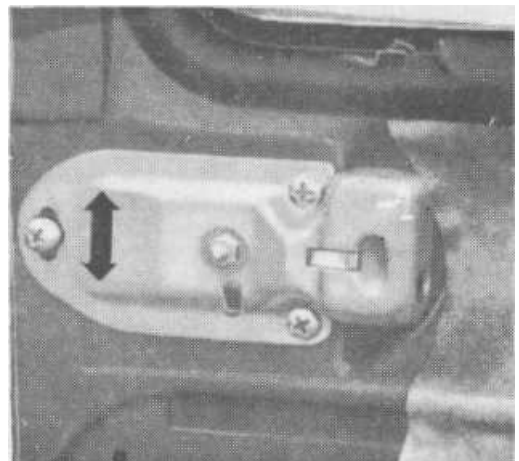
**FIG.11.8 SLIDING DOOR - HINGE LINK SHOWING MOUNTING SCREWS (Sec 17)**



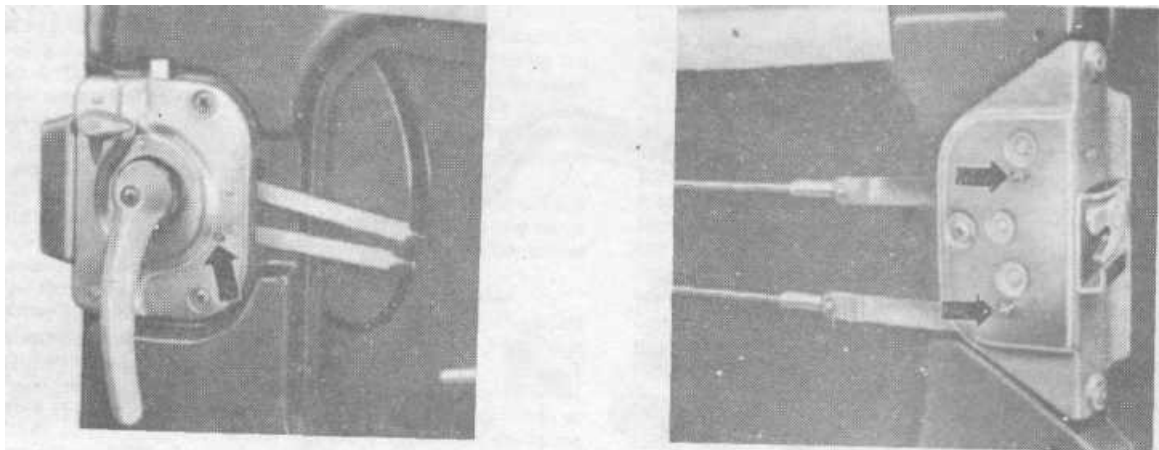
**FIG.11.9 SLIDING DOOR REMOTE CONTROL LATCH LOCK PLATE INDICATING VERTICAL ADJUSTMENT (Sec 17)**



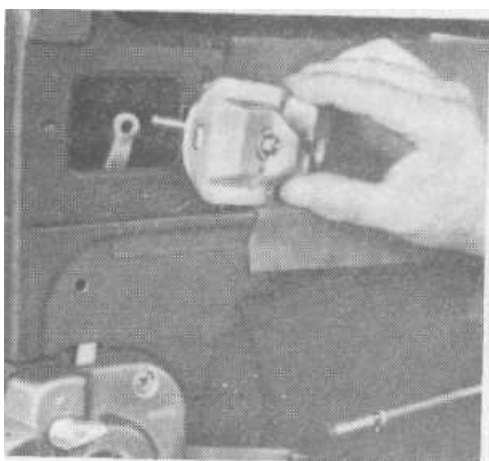
**FIG.11.10 DOOR - CENTRE LATCH STRIKER PLATE INDICATING ADJUSTMENT DIRECTIONS (Sec 17)**



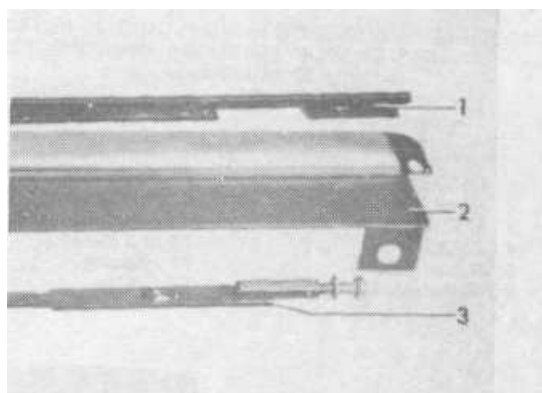
**FIG.11.12 SLIDING DOOR- RETAINER LATCH SHOWING ADJUSTMENT DIRECTIONS (Sec 17)**



**FIG.11.11 REMOTECONTROL LATCH (LEFT) AND CENTRE LATCH (RIGHT) SHOWING POSITIONS OF SETTING SCREWS OR PINS (Sec 17)**



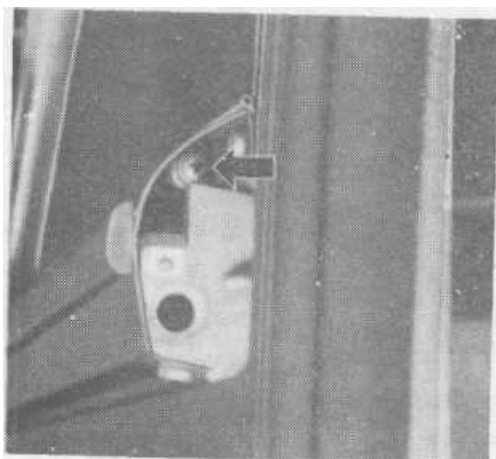
**FIG.11.13 SLIDING DOOR - REMOVING THE DOOR RETAINER CATCH (Sec 18)**



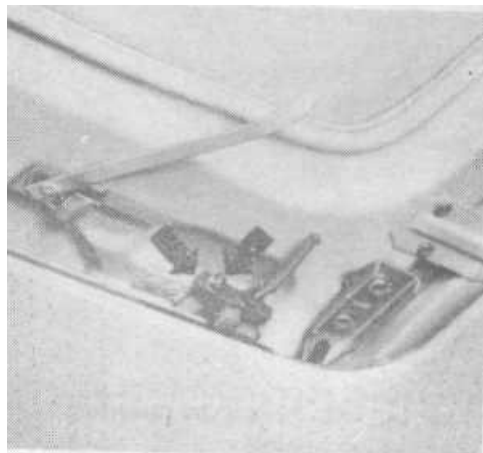
**FIG.11.14 SLIDING DOOR - CENTRE RUNNER COVER COMPONENTS (Sec 18)**

7 Beading  
2 Cover

3 Retaining strip



**FIG.11.15 SLIDING DOOR - CENTRE RUNNER COVER RETAINING STRIP TENSIONING SCREW (Sec 18)**



**FIG.11.17 SLIDING ROOF- REAR LIFTER SHOWING LEAF SPRING MOVED AWAY AND LOCK NUT AND UFTER P (ARROWED) (Sec 20)**

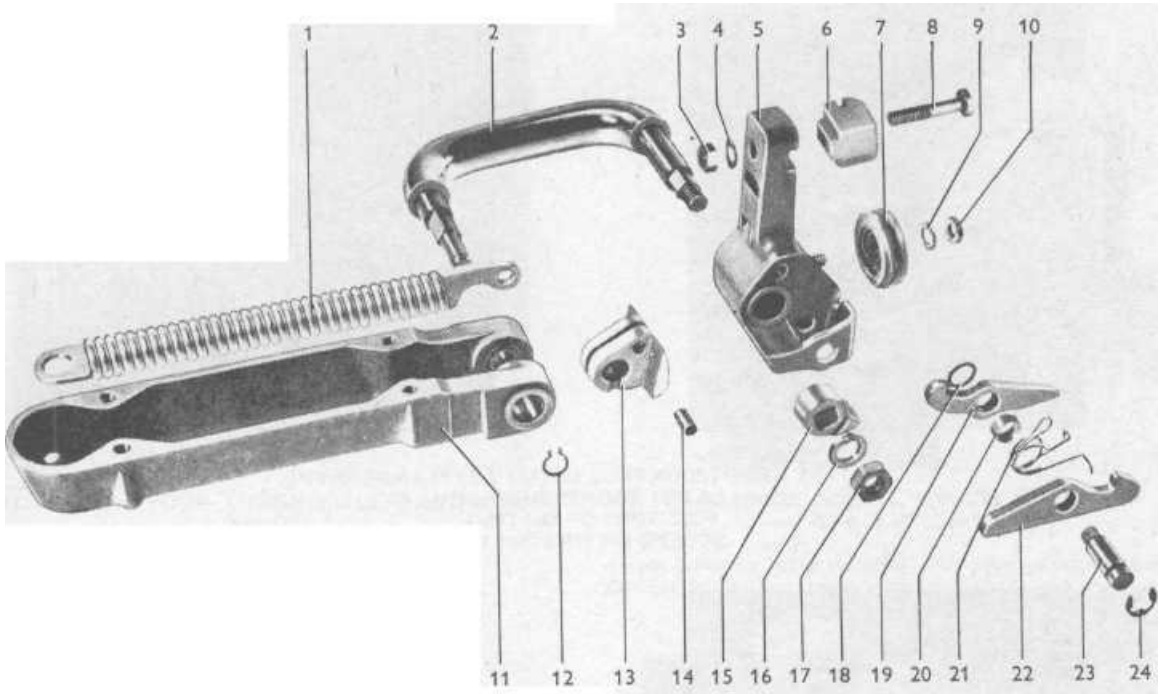


FIG.11.16 SLIDING DOOR- HINGE LINK ASSEMBLY COMPONENTS (Sec 18)

- 7 Return spring
- 2 Hinge link
- 3 M6nut
- 4 Lock washer
- 5 Roller bracket
- 6 Guide block

- 7 Roller and bearing
- 8 Phillips screw
- 9 Spring washer
- 10 M 6 nut (thin)
- 11 Housing
- 12 Circlip

- 13 Pivot
- 14 Pin
- 15 Operating cam
- 16 Spring washer
- 17 M8 nut
- 18 Washer

- 19 Lower locking lever
- 20 Spacer
- 21 Spring
- 22 Upper locking lever
- 23 Pin
- 24 Circlip

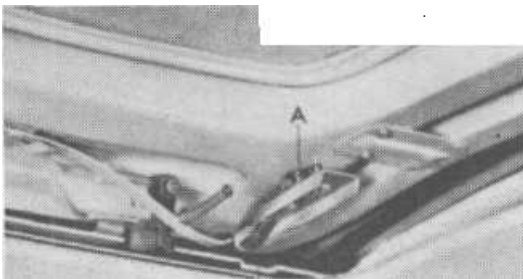


FIG.11.18 SLIDING ROOF- REAR GUIDE HEIGHT ADJUSTER SCREW (A) AND RECESS IN CHANNEL (B) (Sec 20)

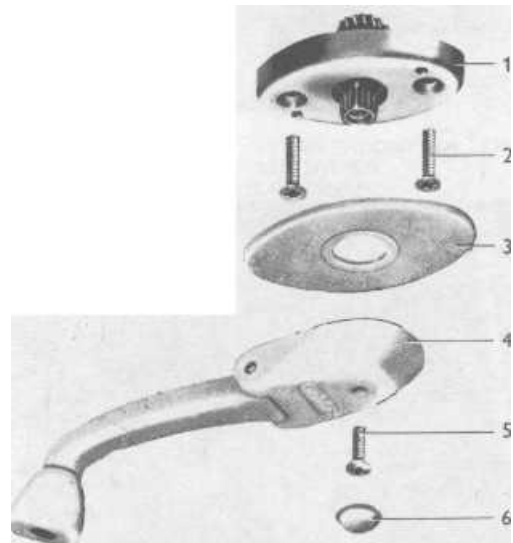


FIG.11.19 SLIDING ROOF - CRANK HANDLE AND GEAR COMPONENTS (Sec 20)

- 7 Drive gear
- 2 Gear retaining screws
- 3 Escutcheon

- 4 Crank handle
- 5 Handle screw
- 6 Cap

4 Check the height of the rear end of the roof. This is done by swinging the leaf springs out to one side and then slackening the hexagon lock nut and screw. Move the lifter pin in the elongated hole to correct the height, (Fig.11.17), at the same time the rear guides can be adjusted for height so that they run in the recesses in the runners. This prevents the roof bouncing about when open on rough surfaced roads (Fig.11.18).

5 Set the sliding roof panel exactly square in the aperture. Turn the cable drive gear shaft clockwise as far as it will go and come back  $1/4$  turn. Then push the gear back into mesh with the cables and secure it and replace the handle.

6 Pull forward the trim panel and clip it back in position.

7 If the front of the roof is set at the wrong height, the front guide screws should be loosened and the adjusting screw turned as required (Fig.11.20).

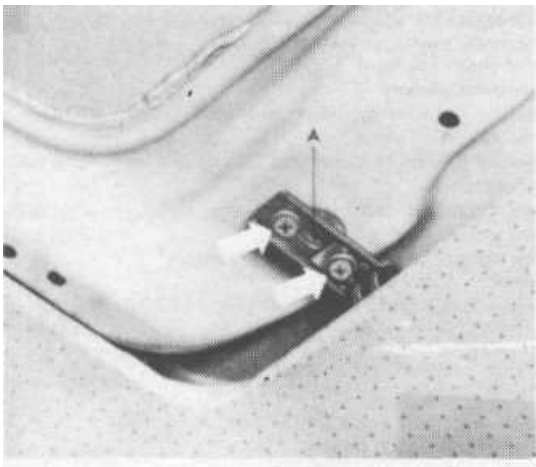
8 Water which may enter the roof opening is collected in channels in the roof frame and drains out through hoses fitted at the front centre and rear of the channels. Make sure the hoses are not blocked. The front ones can be cleared from above with

some flexible wire. The centre and rear ones can be cleared from below after removing the non-return valves on the ends.

## 21 Pop-up and hinged roofs - checking and maintenance

1 The most important points to check on the opening type roof are the condition of the special weather seal strips and the security of the mounting bracket screws. If any sealing strip comes adrift get it fixed before it is trapped and damaged. The main roof seal strip incorporates steel clips which may have lost some of their tension. Pull the strip clear, squeeze the clips together and then push the seal back on. See that all the pivot pins of the support brackets are lightly oiled and the slotted runners thinly greased.

2 The fabric parts should be wiped clean without the use of detergents and should never be folded and left damp. Whenever conditions require the roof to be closed whilst wet be sure to open it and dry it out at the first opportunity.



**FIG.11.20 SLIDING ROOF- FRONT GUIDE HEIGHT ADJUSTMENT SHOWING SECURING SCREWS (ARROWED) AND ADJUSTING SCREW (A)**  
(Sec 20)

# Chapter 12 Supplement:

## Revisions and information on later models

### Contents

<b>Introduction</b> ... ..	1	Master cylinder	
<b>Revised routine maintenance schedules (1968 to 1974)</b> ...	2	<b>Electrical system...</b> ... ..	9
<b>Specifications</b> ... ..	3	Instrument panel (August 1974 on) - removal and refitting	
<b>Engine</b> ... ..	4	Heated rear window	
Pushrod tubes - removal with engine in position		Warning buzzer system (North America)	
<b>Cooling, heating, exhaust</b> ... ..	5	Speedometer drive cable - renewal	
Supplementary fuel fired heater - fault diagnosis		Alternator - description and precautions	
<b>Fuel system</b> ... ..	6	Alternator drivebelt - adjustment	
Air cleaner (1973 on)		Alternator - testing in position	
Solex carburettor - throttle valve damper		Alternator - removal and refitting	
Solex carburettor - modified adjustment procedure		Alternator - overhaul	
<b>Transmission</b> ... ..	7	Headlamp washers	
Modified 1st/2nd synchro hub		Steering column switches and lock (up to 1974) - removal and refitting	
Gearchange rod - modification		Steering column switches and lock (1975 on) -removal and refitting	
Type 091 manual gearbox (August 1975 on) - dismantling			
Type 091 manual gearbox (August 1975 on) - examination and renovation		<b>Steering and suspension...</b> ... ..	10
Type 091 manual gearbox (August 1975 on) - reassembly		Rear torsion bars	
Type 091 manual gearbox (January 1976 on) - lubrication		Steering gear roller shaft oil seal - renewal	
<b>Braking system</b> ... ..	8	<b>Bodywork</b> ... ..	11
Disc calipers (Girling type)		Sliding door adjustment (Chassis No <b>214 2000 001</b> on)	

### 1 Introduction

The information contained in this Supplement refers specifically to models produced after 1973. Where supplementary or modified details are not included, then refer to the original Chapters of this manual.

### 2 Revised routine maintenance schedules (1968 to 1974)

#### Weekly

- Check engine oil level
- Check brake fluid level
- Check battery electrolyte level
- Check tyre pressures
- Check washer fluid level
- Check operation of lights and horn

#### Every 3000 miles (5000 km)

- Renew engine oil and clean oil strainer

#### Every 6000 miles (10 000 km)

- Engine**
- Check drivebelt tension
- Check ignition dwell angle and timing
- Check adjustment of throttle positioner
- Check exhaust system for leaks
- Check valve clearances
- Check engine idle adjustment

#### Transmission

- Check clutch pedal free movement

- Check driveshaft boots for damage
- Check transmission oil level

#### Steering and suspension

- Check balljoints for play and damage to gaiters

#### Brakes and tyres

- Check brake pedal travel
- Check handbrake adjustment
- Check disc pad wear
- Check for tyre tread wear or damage

#### Every 12 000 miles (20 000 km)

- Engine**
- Renew distributor contact points
- Renew spark plugs

#### Brakes

- Check rear brake linings for wear
- Suspension
- Lubricate front axle

#### Every 18 000 miles (30 000 km)

- Clean and refill oil bath type air cleaner
- Renew paper element type air cleaner

#### Every 30 000 miles (50 000 km)

- Clean out front and rear hub bearings, repack with fresh lubricant and adjust front bearings

#### Every 48 000 miles (80 000 km)

- Renew charcoal canister (if fitted)

#### Every two years

- Renew hydraulic fluid in braking system



### 3 Specifications

#### Fuel system

Carburettor (August 1975 on)

Type	Solex 34 PICT 3
	26 mm
Main jet	x125
Air correction jet	80z
Pilot jet	55
	120
Auxiliary fuel jet	47.5
	90
Enrichment	2 x9.5
	1.5
Needle valve washer	0.5
Idle speed	800 to 950 rpm
CO level	1.0 to 3.0%
Fuel octane	RON 91

#### Ignition system

Distributor (from August 1975 - Number 043 905 205 L)

Timing	7.5° BTDC at 750 to 900 rpm with distributor vacuum hose disconnected from distributor and plugged
	44 to 50°
Dwell angle	
Centrifugal advance:	
1050 to 1400 rpm	Begins
1500 rpm	4 to 8°
2200 rpm	9 to 13°
3600 rpm	20 to 24°
Vacuum advance:	
Begins	50 to 100 mm Hg
Ends	200 mm Hg

#### Manual transmission

Type 091 - August 1975 on

Identification code:

CU	Standard
CV	With limited slip differential
CW	With mountain ratio
CX	With limited slip and mountain ratio

Gear ratios:

1st	3.78 : 1
2nd	2.06 : 1
3rd	1.26 : 1
4th	0.82 : 1
Reverse	3.28 : 1
Final drive ratios'	
Standard	5.428 : 1
	5.857 : 1
Oil capacity	6.125 Imp pts (7.35 US pts, 3.5 litres)

#### Electrical system

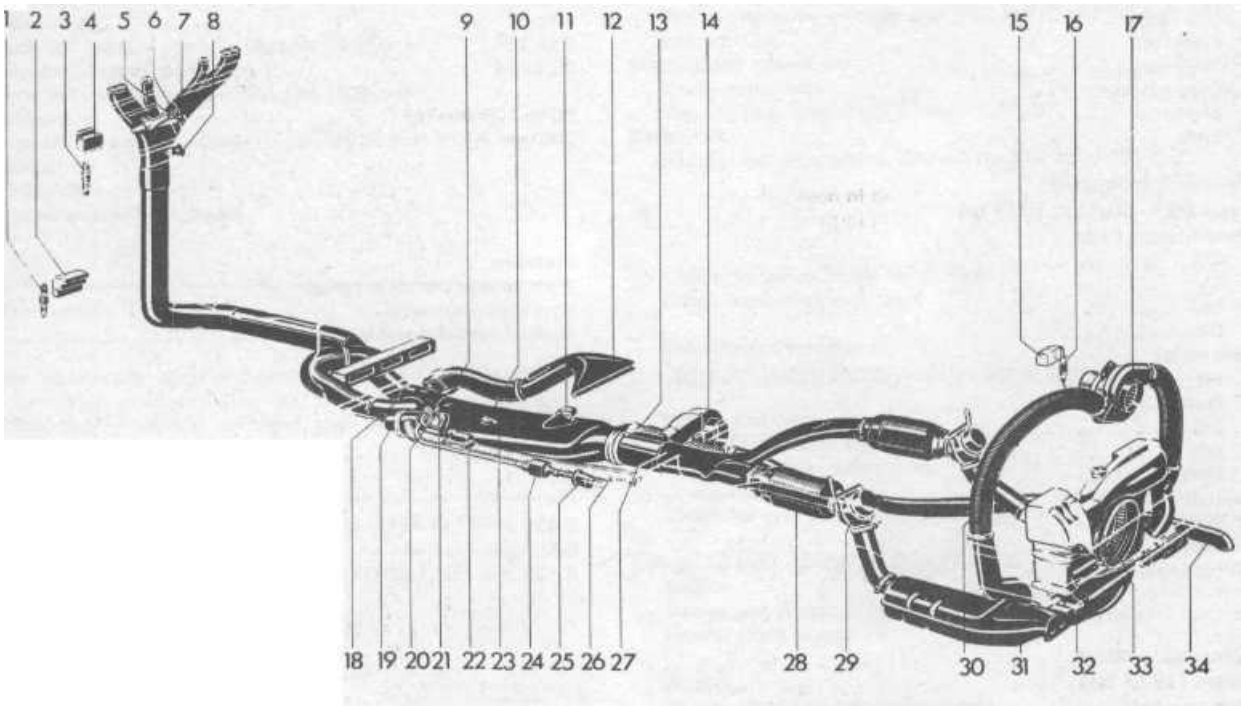
Fuses (1973 on)

Fuse number	Lamp or circuit protected
1	Left-hand rear side marker lamp Left-hand tail lamp
2	Rear number plate lamp Front parking lamp Front side marker lamp Right-hand tail lamp Right-hand rear side marker lamp
3	Left-hand headlamp low beam
4	Right-hand headlamp low beam
5	Left-hand headlamp main beam and indicator
6	Right-hand headlamp main beam
7	Spare
8	Front interior lamp Rear interior lamp (1975 on)
9	Hazard warning circuit Buzzer warning system

- 10 Supplementary heater (North America)
  - 10 Rear interior lamp (up to 1974)
  - 10 Supplementary heater (North America)
  - 10 Heated rear window
  - 11 Windscreen wipers
  - 11 Reversing lamps
  - 11 Fuel gauge
  - 11 Kickdown (automatic transmission except 1976)
  - 11 Direction indicators
  - 11 Generator warning lamp
  - 11 Oil pressure warning lamp
  - 12 Horn
  - 12 Brake stop lamps
  - 12 Brake warning lamp
- Fuse identification*      *Red 16 amp. White 8 amp*

**Alternator**

Mean regulating voltage...	...	...	...	...	...	...	14v
Nominal output speed	...	...	...	...	...	...	2200 rpm
Maximum current	...	...	...	...	...	...	50A
Maximum output	...	...	...	...	...	...	700w
Minimum brush length.	...	...	...	...	...	...	0.2 in (5.0 mm)



**FIG.12.1 SUPPLEMENTARY HEATER (1974 ON)**

- |                              |                            |                          |                       |
|------------------------------|----------------------------|--------------------------|-----------------------|
| 1 Overheating switch (8 amp) | 9 switch                   | 17 Warm air blower       | 26 Air hose           |
| 2 Relay                      | 10 Temperature sensor      | 18 Warm air distributor  | 27 Flap valve housing |
| 3 Fuse                       | 11 Overheating switch      | 19 Combustion air blower | 28 Heat exchanger     |
| 4 Safety switch              | 12 Thermoswitch            | 20 Glow spark plug       | 29 Warm air flap      |
| 5 Warm air lever             | 13 Heater                  | 21 Fuel connection       | 30 Warm air hose      |
| 6 Heater flap lever          | 14 Injector                | 22 Coil                  | 31 Heat exchanger     |
| 7 Fresh air lever            | 15 Blower                  | 23 Heater body           | 32 Non-return flap    |
| 8 Temperature regulating     | 16 Relay (warm air blower) | 24 Metering pump         | 33 Engine fan         |
|                              |                            | 25 Filter                | 34 Exhaust tailpipe   |

#### 4 Engine

##### *Pushrod tubes - renewal with engine in position*

- 1 Damaged or leaking pushrod tubes can be renewed without the necessity of removing the engine.
- 2 Refer to Chapter 1 and remove the rocker cover.
- 3 Remove the rocker shaft and withdraw the pushrods.
- 4 Using a screwdriver, lever the damaged pushrod tube out.
- 5 Compress the new telescopic type pushrod tube and install it complete with new seals so that the thinner end of the tube is towards the cylinder head.
- 6 Refit the components which were removed and then adjust the valve clearances. Refit the rocker cover.

#### 5 Cooling, heating and exhaust systems

##### *Supplementary fuel fired heater - fault diagnosis*

<b>Symptom</b>	<b>Reason</b>
Fuse blown	Fault in heater relay Fault in temperature regulating switch
Heater fails to run-on for specified period when ignition switched off	Fault in thermostwitch
Air circulation blower does not operate at two speeds	Fault in heater relay
Air circulation and combustion air blower continue to run after specified period although heater switched off	Fault in heater relay Fault in thermostwitch
Heater gives off smoke and fumes	Fault in combustion air blower Fault in fuel pump Fault in exhaust pipe

#### 6 Fuel system

##### *Air cleaner (1973 on)*

- 1 On later models, a paper element type air cleaner is used instead of the earlier oil bath type.
- 2 To renew the element, pull off the vacuum hose from the temperature control device on the intake spout and release the vertically positioned toggle clip.
- 3 Pull the air cleaner casing from its lower and front mountings.
- 4 Release the four toggle clips and separate the two sections of the casing. Wipe out the casing and discard the filter element.
- 5 Refit the new element by reversing the removal operations, noting that the casing engages in the rubber grommet before engaging it with its lower mounting.

##### *So/ex carburettor - throttle valve damper*

- 6 After August 1975 a throttle valve damper is fitted to the Solex 34 PICT 3 carburettor.
- 7 Adjustment should be made with the damper plunger pushed fully in so that there is a gap of 0.04 in (1.0 mm) between the end of the plunger and the operating lever.

##### *Single Solex carburettor — modified adjustment*

- Note:** Procedure for twin-carburettors is as described in Chapter 3.
- 8 On the Solex 34 PICT 3 carburettor, the following idling adjustment procedure is recommended to eliminate stalling during warm-up or the throttle valve sticking when the engine is at the normal operating temperature.

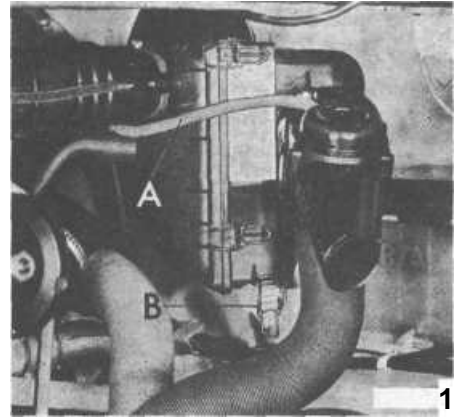


FIG.12.2 AIR CLEANER (PAPER ELEMENT TYPE)

A Vacuum pipe

B Toggle clip

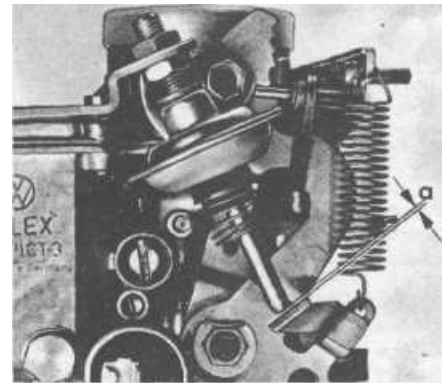


FIG.12.3 CARBURETTOR THROTTLE VALVE DAMPER

$a = 0.04 \text{ in (1.0 mm)}$

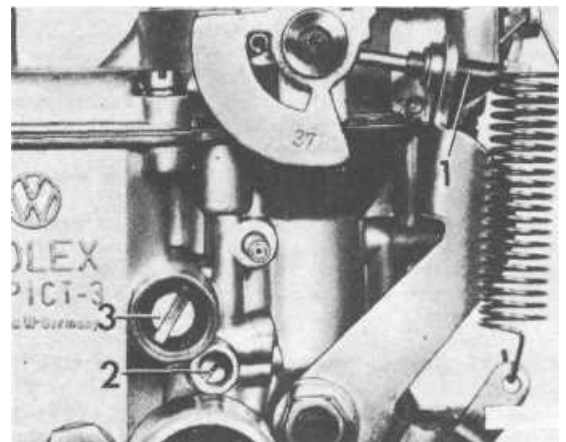
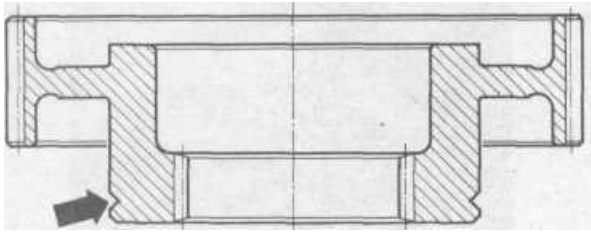


FIG. 12.4. CARBURETTOR ADJUSTING POINTS

1 Throttle adjusting screw

2 CO adjusting screw

3 Idle adjusting screw



**FIG.12.5 CROSS SECTIONAL VIEW OF MODIFIED 1ST/2ND SYNCHRO HUB GROOVE (ARROWED)**

- 9 Have the engine at the normal operating temperature and idling speed. Make sure that the choke is fully OFF.
- 10 Pull the distributor vacuum advance tube from the carburettor and substitute a vacuum gauge.
- 11 Screw in the throttle adjusting screw (1) until the vacuum gauge shows a reading (Fig. 12.4).
- 12 Now unscrew the screw until the vacuum drops to zero. From this setting of the screw, unscrew it a further  $\frac{1}{2}$  turn.
- 13 Readjust the idle speed to between 800 and 900 rpm using the idle adjusting screw (3), (Fig.12.4).
- 14 The CO exhaust emission level should now be checked using a reliable exhaust gas analyser.
- 15 If the level is not within 1 to 3% adjust the position of the screw (2), (Fig.12.4).
- 16 Finally reset the idle speed to specification using screw (3), (Fig.12.4).

## 7 Transmission

### *Modified 1st/2nd synchro hub*

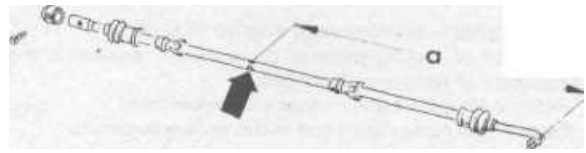
- 1 Should a replacement 1st/2nd synchro hub be required for a gearbox on a vehicle built before August 1975 then unless the part is very old stock, it will be found that the synchro hub has a wider centre section and incorporates an identification groove.
- 2 When this modified type of synchro hub unit is fitted, it is important that the adjustment described in Chapter 6, Section 58, paragraphs 2 and 3 is ignored and any original adjustment shims removed.

### *Gearchange rod - modification*

- 3 Commencing November 1976, Chassis No 217 2 053 839, the gearchange rod is now supported on three bushes as an aid to smoother operation and elimination of rattles.
- 4 Earlier models can be modified if the engine/gearbox is removed and the rear gearchange rod withdrawn.
- 5 The additional bush can be correctly fitted if two (6.1 mm diameter) holes are drilled in accordance with the diagram. The holes should be offset at  $90^\circ$  to each other.
- 6 Later models have a gearchange rod locking screw which does not have locking wire but has thread locking compound applied to its threads. Both types of screw are interchangeable but the later type should always be renewed once it has been removed.

### *Type 091 manual gearbox (August 1975 on) - dismantling*

- 7 With the engine/transmission removed from the vehicle and the gearbox separated from the engine as described in Chapter 1, clean away all external dirt using paraffin and a stiff brush or a water soluble solvent.
- 8 Read this Section right through before starting work and note that there will be a need for some special tools. Remove



**FIG.12.6 GEARCHANGE ROD BUSH FITTING DIAGRAM**

a 43.03 in (1093 mm)

the clutch release mechanism (Chapter 4).

- 9 Remove the screws and nuts securing the clutch housing to the gear casing at the front and carefully draw it off over the input shaft.

10 Undo the circlip in part of the reverse gear and sleeve on the input shaft and draw it along the shaft so that the gear and sleeve may be drawn along behind it until it is clear of the splined part. Unscrew the front section of the shaft which is located into the other part with a threaded stud.

- 11 Remove the sealing caps from the centres of the driving flanges by punching the blade of a screwdriver through them and levering them out.

12 Remove the circlips from round the splined shaft ends. The flanges can then be levered off the end of the shafts.

- 13 Now undo the crosshead screws which hold the lockplates and take off the lockplates.

14 The differential bearing adjusting rings must now be removed. First mark them with a scriber against the casing and as you take them out count the turns so that you will be able to get them back to the same position.

15 The removal of the adjuster rings is difficult without the special VW tool 381/15 but it can be achieved if the rings are rotated carefully using a brass drift and a hammer. Once they start to move, the lockplate can be refitted and used as a wrench.

16 Identify the adjuster rings L and R before removal otherwise their alignment marks will be useless on reassembly.

17 Once the adjuster rings are withdrawn, the differential can be removed by tilting the crownwheel towards the rear of the casing but still keeping its teeth in mesh with the drive pinion.

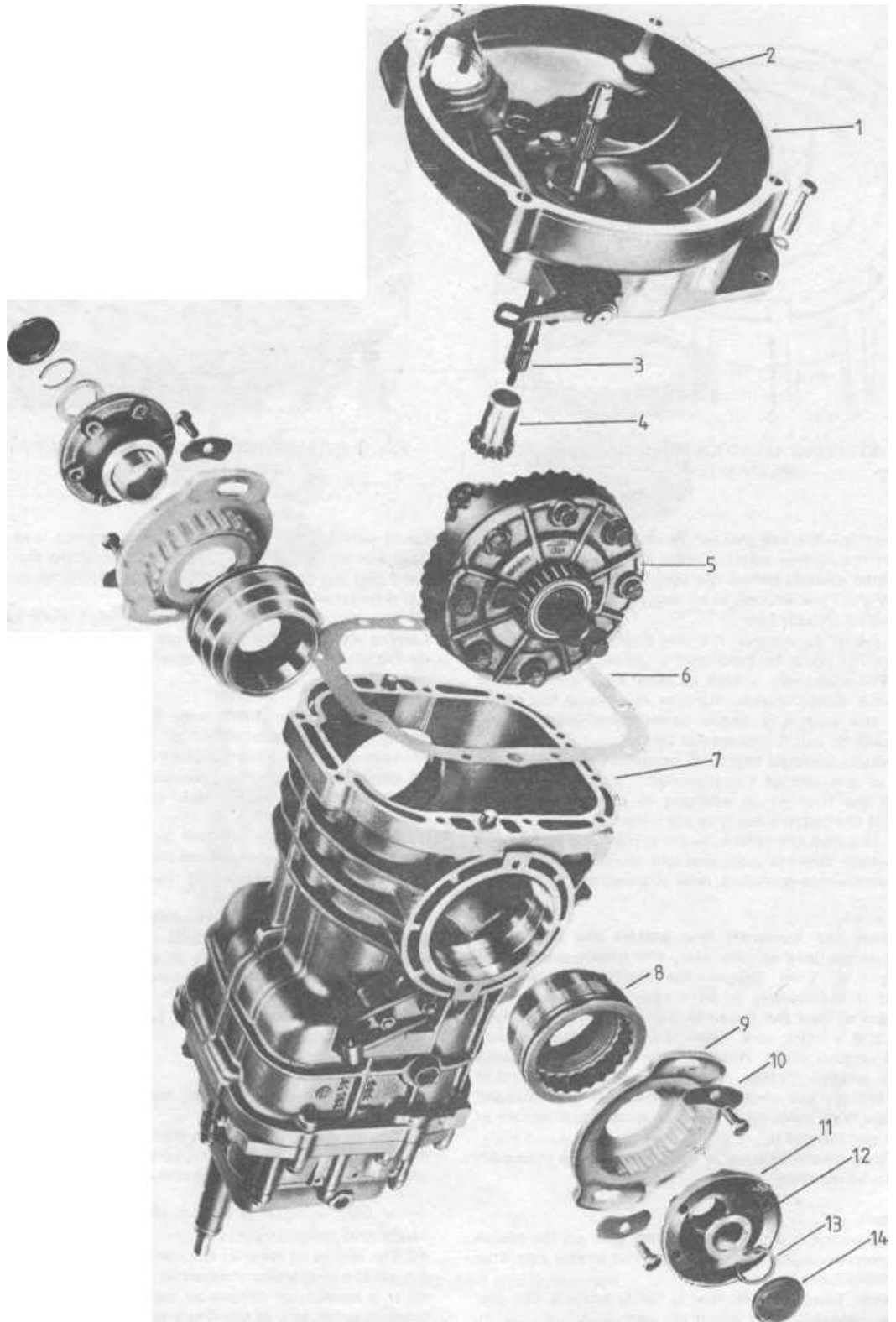
- 18 Unscrew the bolts and lift the gearchange lever housing from the gear carrier.

19 Now for the difficult bit. At the clutch end of the casing is the pinion shaft nut which holds the pinion bearing in place in the casing. This has to be removed (and later a new one put back again). As will be seen, the nut, which is of the ring type, has serrations on its outer edge into which VW tool 381/14 fits snugly. If you do not have a suitable tool then this is where you come to a stop. If you do then undo the nut and remove it, take out the shims and set them carefully aside. Now remove the bolts from the carrier and working it gently with pressure on the pinion face draw the carrier off bringing the two gear trains with it.

20 Once removed do not dismantle anything further until the position of the 1st/2nd 3rd/4th selector forks have been carefully marked on the rails. If this is not done and the forks are moved there is the greatest likelihood that gear selection will be upset so that the whole assembly will need repositioning in a special jig (see Selector fork - refitting and adjustment).

21 Undo and remove completely the fork clamping screws and then slide them off the rails, moving the rails as necessary in order to free them. Take note which way round the forks are fitted and which one goes on which rail because they are not the same. Do not drive the rails out of the carrier unless new components are to be fitted (see Gear carrier).

- 22 The reverse selector lever is on a post clamped by a union



**FIG.12.7 TYPE 091 GEARBOX FINAL DRIVE AND BELLHOUSING COMPONENTS**

1	<i>Clutch bellhousing</i>	5	<i>Differential</i>	9	<i>Lockplate</i>	13	<i>Circlip</i>
2	<i>Input shaft</i>	6	<i>Gasket</i>	10	<i>Plate</i>	14	<i>Plastic plug</i>
3	<i>Circlip</i>	7	<i>Gearcase</i>	11	<i>Driving flange</i>		
4	<i>Reverse gear</i>	8	<i>Adjusting ring</i>	12	<i>Thrust washer</i>		

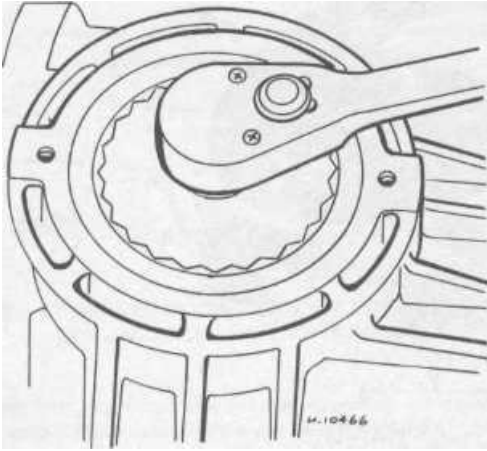


FIG.12.8 REMOVING AN ADJUSTER RING USING THE SPECIAL TOOL

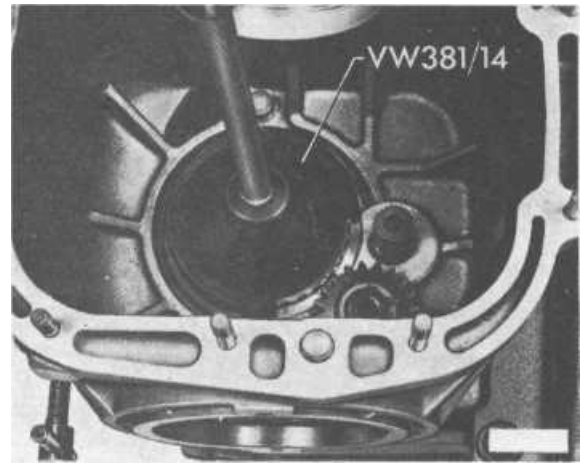


FIG.12.9 REMOVING PINION DRIVESHAFT RING NUT USING THE SPECIAL TOOL

nut. Make sure this is marked also before moving it. The brackets which support the reverse selector cross shafts are also adjustable and must be marked before the securing bolts are undone. Turn the relay shaft just enough to be able to remove the reverse sliding gear and its selector fork.

23 The next job is to remove the two shafts from the gear carrier. The carrier must be supported so that the shafts hang downwards. The mainshaft is kept in place by a circlip under which there is a dished washer. Remove the circlip but watch out because the washer is under considerable pressure and the whole lot will fly out if you are not careful.

24 Press the shafts (meshed together) from the carrier by applying pressure to the end of the mainshaft. A press is recommended with the help of an assistant to prevent the shafts dropping out of the carrier once they are released.

25 The shaft bearings will remain in the carrier and should not be removed unless they are worn and will obviously have to be renewed. Where renewal is needed, refer to paragraph 37.

#### Mainshaft

26 To dismantle the mainshaft first extract the circlip and slide off the thrust washer, 4th gear, the needle bearing and synchronising ring. Now remove the circlip. This presents problems and it is necessary to fit a new one on reassembly. VW have a special tool but it can be done with a pair of long-nosed pliers and a little care. Tape the baulk rings and hub together and remove them. Watch which way they go round. There is now another circlip. A new one will be required at reassembly. Remove the circlip and remove 3rd gear. Expand the split needle cage sufficiently to ease it over the splines of the mainshaft and remove it.

27 The 4th gear needle bearing is integral with the mainshaft and should not be removed.

#### Pinion driveshaft

28 Apply pressure from a press to the 4th gear on the pinion driveshaft to compress the spacer spring. The circlip can then be extracted from the end of the shaft.

29 If the needle bearing inner race is tight, support 4th gear and press the pinion driveshaft out of the race.

30 Withdraw the spacer spring followed by the circlip.

31 Remove 3rd gear, 2nd gear, the needle bearing cage, the circlip, the 1st/2nd synchro and 1st gear. A press will be required to press the latter two components from the shaft.

32 If necessary, tap the anti-rotation ring from the 1st/2nd synchro hub.

33 The inner track for 1st gear needle bearing which is com-

bined with the tapered roller bearing ring nut is to be removed next and should be released by unscrewing the nut. This is very tight and the special tool (VW 2052) should be used to do the job satisfactorily.

34 Support the outer track of the pinion shaft tapered roller bearing and press the shaft from it. If the inner track remains on the shaft remove it with a bearing puller.

#### Gear carrier

35 Do not remove the selector fork rails from the gear casing unless positive action of the detent balls is suspect or the rails must be renewed because of wear.

36 Where dismantling is required, first remove the selector link shaft and the selector link. Unbolt and remove the selector link bracket.

37 Extract the lockplate and circlip, press the mainshaft and pinion driveshaft bearings from the gear carrier.

38 Remove the clamp sleeve, reverse lever support and union nut from the gear carrier.

39 Unbolt and remove the relay shaft and brackets.

40 To extract the detent balls and springs, first drill a small hole in each plug and screw in a self-tapping screw to extract the plug. Cover the hole to prevent the ball and spring being lost.

41 New detent springs should be between 29 and 31 mm in length.

#### Gearchange lever housing

42 Using a pair of pipe grips, twist out the bush/oil seal from the housing.

43 Drive the guide bush from the housing.

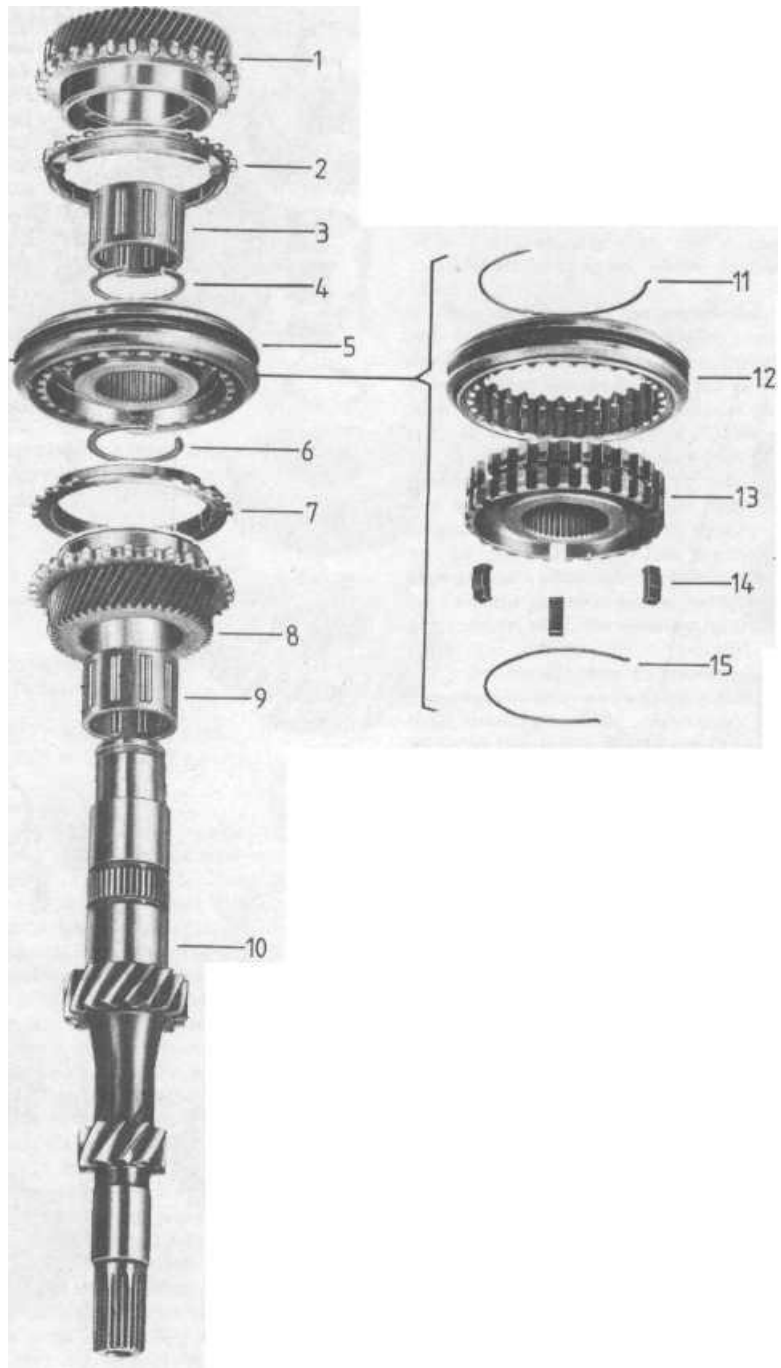
44 Unscrew and remove the reverse lamp switch. On models without a switch, remove the socket headed plug.

#### Type 091 manual gearbox (August 1975 on) - examination and renovation

45 The degree of wear in the components will to a large extent dictate the economics of repair or replacement with a new unit.

46 It is possible to remove all baulk rings for examination. The grooved taper face of the ring provides the braking action on the mating face of the gearwheel cone and if the ridges are worn the braking or synchro action will be less effective. The only way to determine the condition effectively is by comparison with new parts. As the parts are relatively cheap it is considered foolish not to renew them all anyway once the gearbox is fully dismantled.

47 Press each baulk ring onto its cone and measure the gap

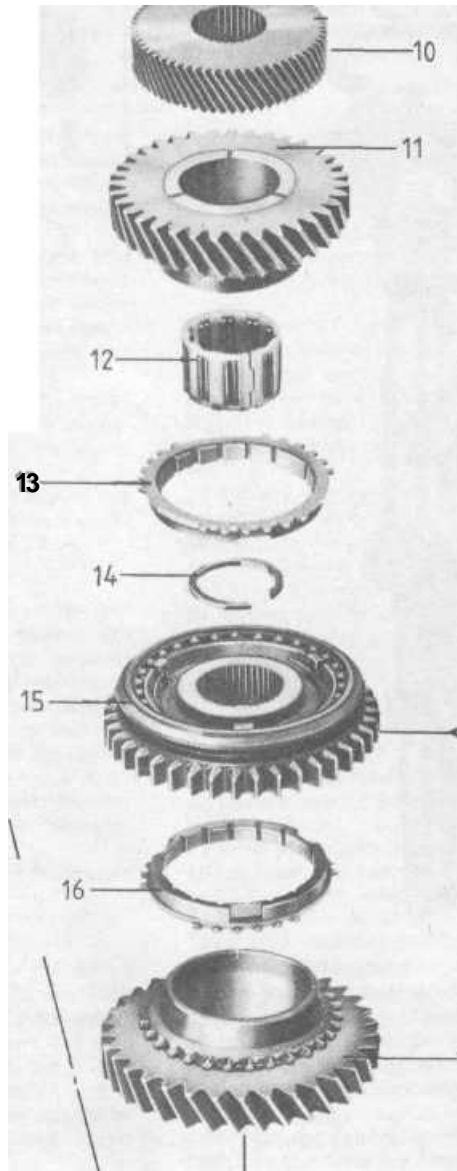
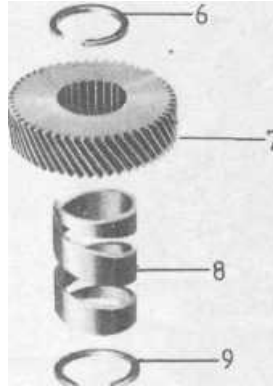
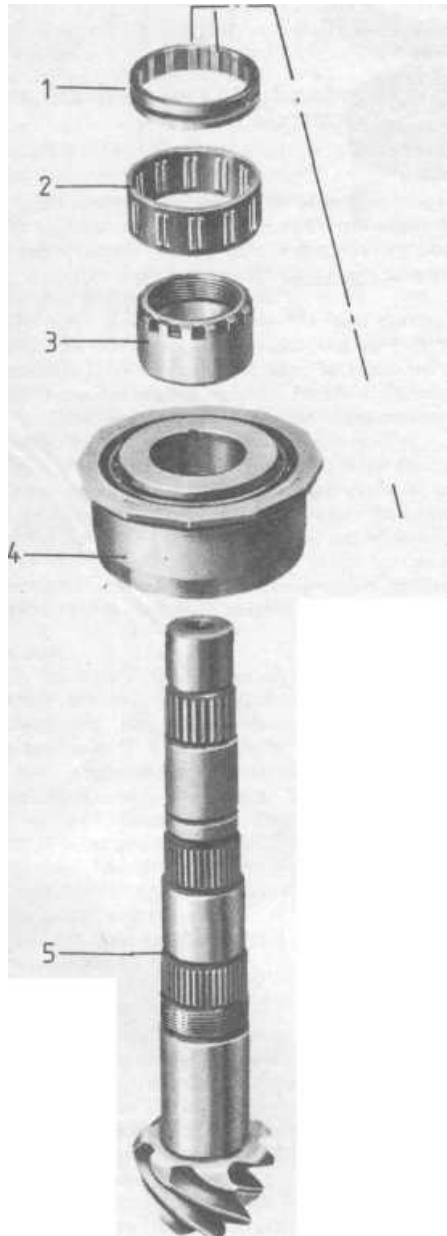


**FIG.12.10 MAINSHAFT COMPONENTS**

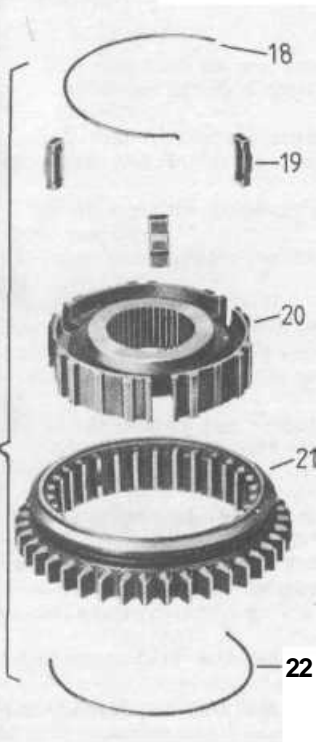
- |   |                |   |                          |    |                |    |                |
|---|----------------|---|--------------------------|----|----------------|----|----------------|
| 1 | 4th speed gear | 5 | 3rd/4th synchro assembly | 8  | 3rd speed gear | 12 | Synchro sleeve |
| 2 | Baulk ring     | 6 | Circlip                  | 9  | Needle bearing | 13 | Synchro hub    |
| 3 | Needle bearing | 7 | Baulk ring               | 10 | Mainshaft      | 14 | Sliding keys   |
| 4 | Circlip        |   |                          | 11 | Spring         | 15 | Spring         |

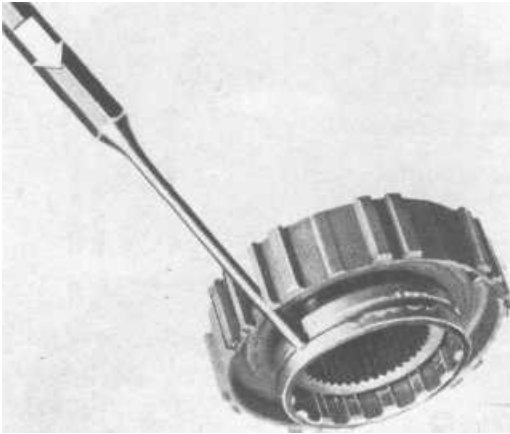


FIG.12.11 COMPONENTS OF THE PINION DRIVESHAFT



- 1 Anti-rotation ring
- 2 1st gear needle bearing
- 3 Combined 1st gear needle bearing/locknut
- 4 Tapered roller bearing
- 5 Pinion shaft
- 6 Circlip
- 7 4th speed gear
- 8 Spacer spring
- 9 Circlip
- 10 3rd speed gear
- 11 2nd speed gear
- 12 2nd gear needle bearing
- 13 Baulk ring
- 14 Circlip
- 15 1st/2nd synchro assembly
- 16 Baulk ring
- 17 1st speed gear
- 18 Spring
- 19 Sliding keys
- 20 Synchro hub
- 21 Synchro sleeve (with reverse)
- 22 Spring





**FIG.12.12 REMOVING ANTI-ROTATION RING FROM 1ST/2ND SYNCHRO HUB**

between the baulk ring and the gear teeth with feeler blades. The gap should be within the following limits:

1st/2nd	0.023 and 0.071 in (0.60 and 1.80 mm)
3rd/4th	0.023 and 0.075 in (0.60 and 1.9 mm)

Otherwise renew the components.

48 Three types of bearings are fitted - ball, needle roller and tapered roller. As a rule needle roller bearings wear very little, not being subject to end thrust of any sort. Check them in position and if there are signs of roughness then they should be renewed. If any bearing should feel the slightest bit rough or show any sign of drag or slackness when revolved then it should be renewed. The double taper roller bearing should be similarly checked. If there is any sign of roughness or endfloat then this is a task for your dealer unless you have a press and special tools. If this bearing is needing renewal the condition of the pinion gear and crownwheel must be very carefully examined. Once these need renewal then the setting of the whole box is altered and clearances and shims have to be recalculated and changed.

49 The teeth of all gears should be examined for signs of pitted mating surfaces, chips or scoring. It must be appreciated that if one gear is damaged then its mating gear on the other shaft must be renewed as well, as the gears are supplied as matched pairs.

50 The synchro hubs should be assembled for checking. It is important that there is no rock or backlash on the splines between the inner hub and outer sleeve. When the baulk rings are being renewed it is good policy to renew the three sliding keys and their locating spring rings as well. The keys fit into the cut-outs in the baulk rings and are subject to wear and the springs weaken with time.

51 To dismantle the synchro units extract the circular springs which engage with the sliding keys and push the hub from the sleeve.

52 With this type of gearbox, the hub does not have any particular alignment with the synchro sleeve and should be refitted on a trial and error basis until the two components exhibit the best sliding fit.

53 When fitting the springs make sure that they run in opposite directions when viewed from each side of the unit, that they engage fully with the sliding keys and their angled ends are located in the hollow key, but on no account have both the angled ends of the two springs engaged in the same key.

54 One of the most critical parts of the Volkswagen gearbox is the operation of the selector forks. The two forks run in grooves in the outer sleeves of the synchro hubs and if the clearance of the forks in the grooves is excessive then there is a likelihood of certain gears jumping out. The clearance of the fork in the groove should not exceed 0.3 mm (0.012 in). Clearance in excess of the maximum could be due to wear on the fork or in the groove or both. It is best therefore first of all to take the forks along to the spares supplier and ask him to compare their thickness with new ones. If the difference in thickness is not enough to compensate for the excess gap between fork and hub groove then the hub assembly will need renewal as well. This is an expensive item but as the gap is somewhat critical there is no alternative. Much depends on the total degree of wear.

55 The selector rails on which the forks are mounted should not have been removed unless worn (see 'Dismantling'). A certain force is needed in order that they overcome the pressure of the spring loaded ball in the groove. This can be measured with a spring balance hooked on to the end of each selector rod. If the required pull is significantly outside the range of 15 to 20 kgs (33 to 44 lbs) then it is advisable to check the detent springs and balls. The balls should be free from pitting and grooves and the selector rods themselves should not be a sloppy fit in the bores. The detent grooves in the rails should not be worn. When the rails are removed do not lose the interlock plungers which fit between the selector and rod grooves.

56 Examine all parts of the casing for signs of cracks or damage, particularly near the bearing housings and on the mating surfaces.

57 If the reverse gear components are to be removed from the transmission case, extract the circlip from the end of the reverse shaft, withdraw reverse driven gear.

58 Drive the reverse shaft from the transmission case.

59 The mainshaft and reverse shaft bearings can be removed from the transmission case once their retaining circlips have been extracted.

60 Wipe out the bottom of the transmission case using a non-fluffy cloth.

#### *Type 091 manual gearbox (August 1975 on) - reassembly*

61 With all parts clean and renewed where necessary, assemble the gearbox in the following sequence. Apply oil to each component as it is assembled and observe absolute cleanliness.

#### **Mainshaft**

62 Reassembly is a reversal of dismantling but note the following points.

63 When fitting 3rd/4th synchro make sure that the groove on the sleeve (arrowed Fig.12.13) is towards 4th gear.

#### **Pinion driveshaft**

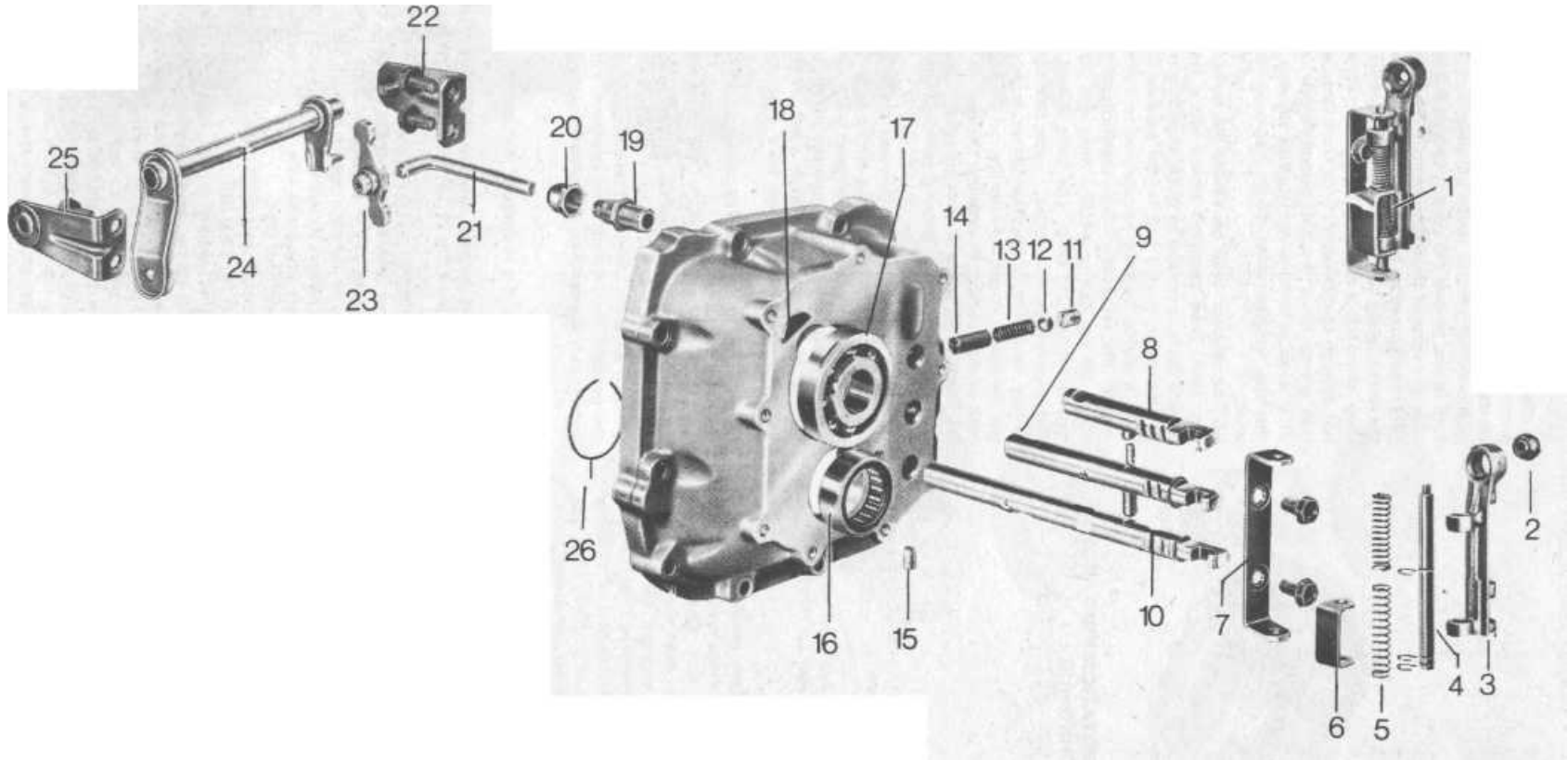
64 When fitting the tapered roller bearing, the inner track should be heated to 212°F (100°C) in water before fitting.

65 The combined 1st gear needle bearing inner track and ring nut should be heated in water to 140°F (60°C) before fitting to the mainshaft but make sure that the tapered roller bearing track has cooled down first.

66 Using the special tool (VW 2052) tighten the ring nut (still hot) to 145 lbft (177 kgf m).

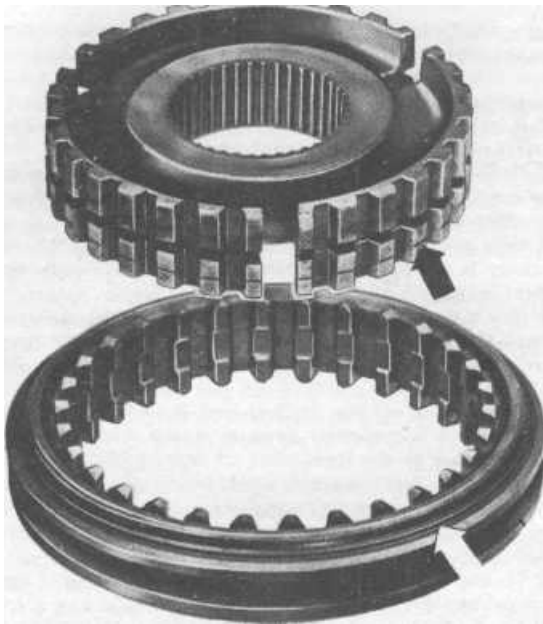
67 The pinion driveshaft should now be fitted in the transmission case and its turning torque checked either with a torque wrench or by winding a cord round the shaft splines and attaching its end to a spring balance. Oil the bearing and turn it several times in both directions to settle the bearings. The turning torque for new bearings should be between 6 and 21 kgf cm (5.2 and 18.3 lbf in) or if the original bearings have been used again, 3 to 7 kgf cm (2.6 to 6.1 lbf in).

68 Once the torque has been checked, remove the driveshaft from the transmission casing and continue reassembly, which is in the reverse order of dismantling. Fit 1st gear and needle bearing, 1st/2nd synchro, 2nd gear and needle bearing, 3rd gear



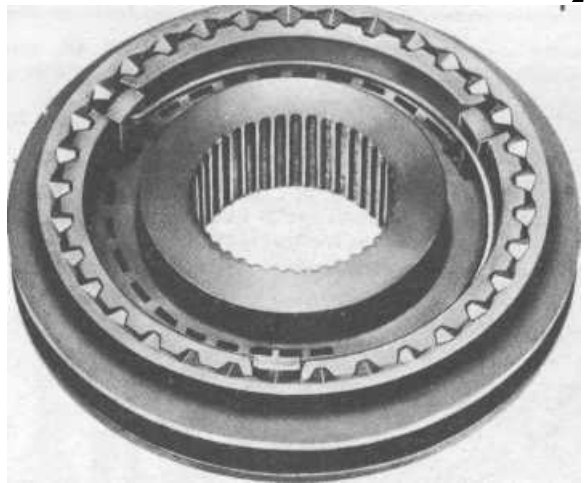
**FIG.12.13 COMPONENTS OF THE GEAR CARRIER**

- |                                      |  |                                |                             |                               |
|--------------------------------------|--|--------------------------------|-----------------------------|-------------------------------|
| <b>1</b> Intermediate selector lever | <b>6</b> Stop                                | <b>11</b> Detent hole plug     | bearing                     | <b>22</b> Relay shaft bracket |
| <b>2</b> Ball joint                  | <b>7</b> Intermediate selector lever bracket | <b>12</b> Detent ball          | <b>17</b> Mainshaft bearing | <b>23</b> Rocker lever        |
| <b>3</b> Link                        | <b>8</b> 3rd/4th selector rod                | <b>13</b> Detent spring        | <b>18</b> Lockplate         | <b>24</b> Relay shaft         |
| <b>4</b> Selector lever shaft        | <b>9</b> Reverse selector rod                | <b>14</b> Detent sleeve        | <b>19</b> Clamp sleeve      | <b>25</b> Relay shaft bracket |
| <b>5</b> Coil springs                | <b>10</b> 1st/2nd selector rod               | <b>15</b> Plug                 | <b>20</b> Union nut         | <b>26</b> Circlip             |
|                                      | <b>16</b> Pinion driveshaft needle           | <b>21</b> Rocker lever support |                             |                               |

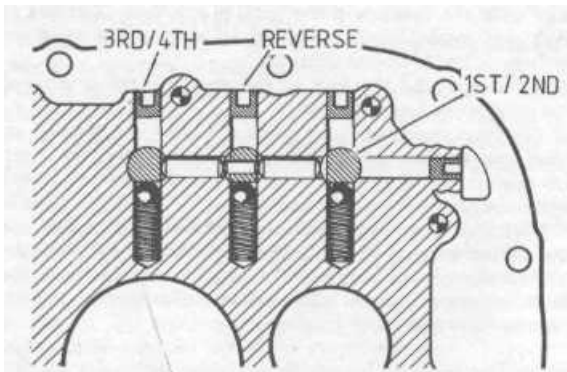


**FIG.12.14 3RD/4TH SYNCHRO HUB AND SLEEVE**

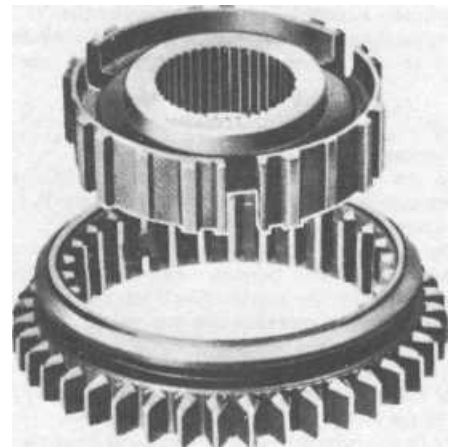
*Line on hub must be at bottom (black arrow) when groove on sleeve is uppermost (white arrow)*



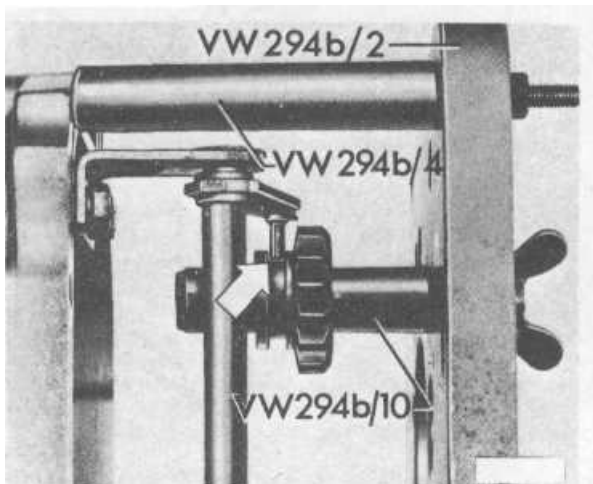
**FIG.12.15 SYNCHRO SIDE TO SIDE SPRING LOCATION**



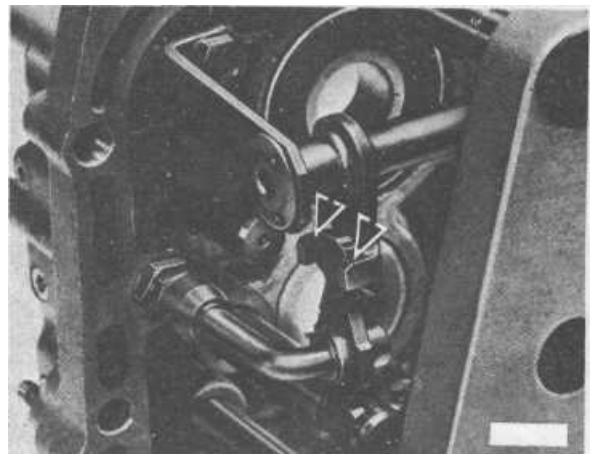
**FIG.12.17 SECTIONAL VIEW OF DETENT/SELECTOR SHAFT ARRANGEMENT SHOWING POSITION OF INTERLOCK PLUNGERS**



**FIG.12.16 1ST/2ND SYNCHRO HUB AND SLEEVE**



**FIG.12.18 USING SPECIAL JIG TO SET REVERSE SELECTOR PIN**



**FIG.12.19 ROCKER LEVER EQUAL CLEARANCE POINTS**

(shoulder towards 2nd gear), circlips, spacer spring, 4th gear (shoulder towards spring) and the circlip, but note the following points.

69 Before pressing the 1st/2nd synchro onto the driveshaft, fit a new anti-rotation ring.

70 Once 3rd speed gear is fitted, use feeler blades to check the endfloat. This should be between 0.05 and 0.20 mm. Adjust by using a selective thickness circlip from the following which are available. Try and set the endfloat to the lower tolerance.

Thickness (mm)	Colour of circlip
1.60	Black
1.75	Blue
1.90	Brown
2.05	Grey
2.20	Copper
2.30	Brass
2.40	Silver

### Transmission case

71 Refit the mainshaft and reverse shaft bearings to the transmission case using new circlips.

72 Fit reverse shaft and reverse driven gear, the latter having the oil grooves towards the needle bearing. If the complete reverse shaft/gear assembly has been removed then it is simpler to refit completely assembled, including the shaft needle bearing, circlip and thrust washer. Tap home, using a plastic faced hammer.

### Gear carrier

73 Fit the selector detent balls and springs.

74 Depress the detent balls and springs and fit the selector shafts. Make sure that the interlock pins are in position.

75 Drive in new detent plugs.

76 Press the mainshaft bearing into the gear carrier so that the numbers engraved on the bearing outer track are visible when viewed from outside the carrier. Once the milled edge of the bearing aligns with the recess in the gear carrier, press the semi-circular lockplate into the recess.

77 Fit the circlip and press in the pinion driveshaft bearing.

78 Fit the clamp sleeve, reverse lever support and the union nut. Tighten the sleeve to 32 lbf ft (4.4 kgf m).

79 Loosely fit the reverse gear relay shaft and brackets.

80 Fit the selector link bracket and tighten the bolts to 18 lbf ft (2.5 kgf m).

81 Fit the selector link and selector link shaft.

82 The selector shafts and forks will require adjustment (as described later) once the gear train has been fitted to the carrier.

83 To fit the gear train, mesh together the mainshaft and the pinion driveshaft. Slip the 3rd/4th selector fork onto its shaft and make sure that it slides freely. Support the ends of the gear shafts and then lower the gear carrier down onto the opposite ends of the shafts. Apply pressure to the inner track of the mainshaft bearing using a tubular distance piece and a press. A heavy hammer may do the job if an assistant is available to guide the pinion driveshaft into the carrier and to retain the selector fork onto its shaft.

84 The dished washer and a new circlip must now be fitted to the mainshaft. Make sure that the circlip snaps into its groove against the pressure of the washer and then compress it fully with a pair of pipe grips until it bottoms in its groove.

### Selector forks - refitting and adjustment

85 Correct setting of the selector forks is vital for smooth gearchange and minimum wear on the selector components. Basically, what must be achieved is to so adjust the selector forks that when a gear is selected, the fork is central in its synchro sleeve groove (or pin in reverse sliding gear groove) without any side pressure to cause the fork to rub against the sides of the groove. A great deal of trial and error work will be needed to achieve this unless the original components are being refitted and their exact relative positions were marked before dismantling. Where new parts have been fitted, then the only

really satisfactory way to set up the selector mechanism is to use the special setting jig VW 294 b. If this cannot be borrowed then this work should be left to your dealer by taking the assembled gear carrier to him.

86 If the jig is available, fit the gear carrier complete with reverse sliding gear and selector fork.

87 Release the bolts on the reverse relay shaft brackets and slide the bracket (on the selector pin side of the relay shaft) until the selector pin contacts the reverse sliding gear.

88 Now press the opposite bracket against the shaft until all endplay is eliminated. Tighten the bracket bolts to a torque of 14 lbf ft (1.9 kgf m).

89 Check that the clearance at both ends of the rocker lever is equal. If it is not, release the union nut and rotate the reverse lever support as necessary. Retighten the union nut to 22 lbf ft (3.0 kgf m).

90 Adjustment of the 1st/2nd and 3rd/4th selector forks is rather more complicated because if the final drive requires resetting due to the installation of new components, then this must be done first (see paragraph 110).

91 Install the gear carrier to the special jig and then hand tighten the special retaining ring at the pinion gear bearing. This ring is supplied as part of the setting jig.

92 Loosen the nut on the reverse lever support and move the support and lever aside.

93 Fit 1st/2nd selector fork to its shaft but leave it free to slide on the shaft.

94 Reconnect the reverse lever and slightly tighten the union nut on the support.

95 Pull the 1st/2nd selector shaft until 2nd gear detent engages. Now slide the synchro sleeve/fork in the same direction as the shaft was moved until the sleeve slides over the teeth on the baulk ring, and is against 2nd gear.

96 Now centralise the fork in the groove in the synchro sleeve and tighten the fork lock bolt.

97 Turn the mainshaft and select 1st, 2nd and neutral several times and at each gear position check that the fork does not rub against the side of the synchro sleeve groove. If it does, slight readjustment must be carried out.

98 With the gear train in neutral, move the 3rd/4th selector rod until it engages in 3rd gear detent. Adjust the 3rd/4th fork in a similar way to that described for the 1st/2nd fork. During these adjustments, the mainshaft bearing in the gear carrier must be fully seated.

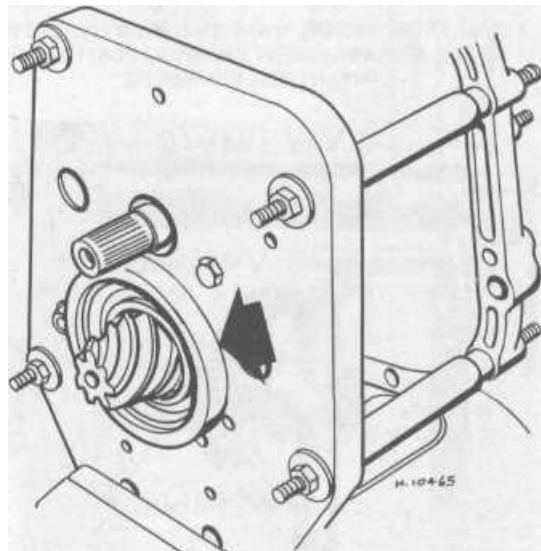


FIG.12.20 SPECIAL PINION BEARING ADJUSTER NUT SUPPLIED WITH SELECTOR SETTING JIG

99 Adjust the union nut on the reverse rocker lever support until the support is just free to slide in and out of its clamp sleeve.

100 Push the reverse (middle) selector shaft until its circlip contacts the face of the gear carrier. Hand tighten the union nut.

101 Without touching its shift fork, press reverse sliding gear towards the gear carrier until there is a clearance between the sliding gear and the mainshaft 2nd gear of between 0.020 and 0.039 in (0.50 and 1.00 mm). Tighten the union nut to 22 lbf lb (3.0 kgf m).

102 Disengage reverse gear and select 2nd gear. Check that there is a clearance between the teeth of reverse sliding gear and 1st/2nd gear sleeve. If not, readjust the reverse lever support after releasing the union nut.

103 Finally check that the interlock mechanism is doing its job by only allowing the selection of one gear at a time. Check that the selector fork lock bolts are all tight at 18 lbf ft (2.5 kgf m).

104 Stick a new gasket to the flange of the transmission case and locate the pinion driveshaft bearing shims in position (refer to paragraph 110 if the pinion/crownwheel has yet to be adjusted).  
105 Insert the gear train into the casing so that the twelve sided shoulder of the pinion bearing seats in its recess.

106 Fit a new retaining nut and with the special tool used to release it, tighten it to 160 lbf lb (21.8 kgf m). Release the nut one quarter of a turn and retighten to the correct torque. Stake the nut by means of its retaining ring.

107 Insert and tighten the bolts which hold the gear carrier to the transmission case. Work in a diagonal sequence and tighten to a torque of 14 lbf ft (1.9 kgf m).

108 To the face of the gear carrier bolt on the selector link and bracket, the selector link and link shaft.

109 If the gearchange lever housing was overhauled, fit a new bush/oil seal. Fit the housing to the gear carrier making sure that the selector inner lever engages with the balljoint of the link. Fit the securing bolts and tighten to 11 lbf ft (1.5 kgf m).

#### Final drive - fitting

110 If the differential has been dismantled or certain components renewed (see paragraph 127) then it is essential that the setting of the crownwheel and pinion is left to your dealer due to the need for special gauges. Under these circumstances, the jig setting of the selector mechanism (paragraphs 85 to 103) should be carried out by him at the same time.

111 Where the differential/final drive has remained undisturbed during the gearbox overhaul operations, then refit it in the following way.

112 Fit the differential into the transmission housing so that the crownwheel and pinion mesh.

113 Fit a new oil seal and O-ring to each of the adjusting rings.

114 Screw in the right-hand adjusting ring (they should have been marked L or R before removal) by the exact number of turns recorded at dismantling until its mark is correctly aligned.

115 Centralise the differential in the transmission housing and screw in the opposite bearing adjuster ring again to the original depth and stopping when the marks on ring and housing are in alignment. Release this ring one complete turn until the clutch bellhousing has been fitted.

116 To the right-hand side fit a new spacer, a lockplate seal, the lockplate, the kidney shaped plates and the Phillips screws.

117 Into the open end of the gearcase, locate the reverse gear sleeve onto the end of the mainshaft.

118 Insert the input shaft, without its circlip but with a threaded connecting stud screwed into its end, and pick up the reverse sleeve. Draw the sleeve towards you on the input shaft and screw the shaft up tight with the mainshaft. Now unscrew it just a fraction (one spline) until the sleeve can be pushed forward freely.

119 Fit a new circlip into the input shaft groove.

120 Using a new joint gasket, bolt the clutch bellhousing to the front of the transmission case. Tighten the bolts to 14 lbf ft (1.9 kgf m).

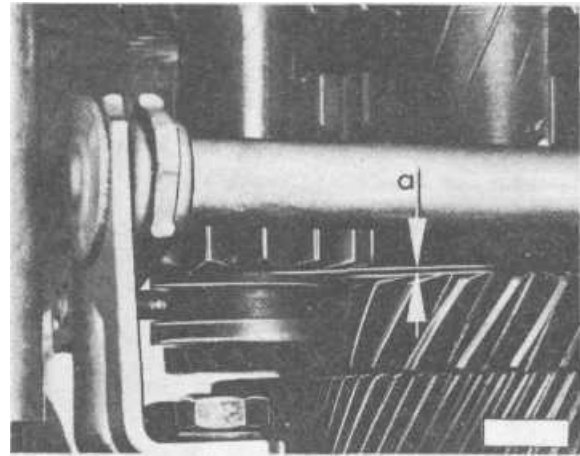


FIG.12.21 REVERSE SLIDING GEAR CLEARANCE (a) TO MAINSHAFT

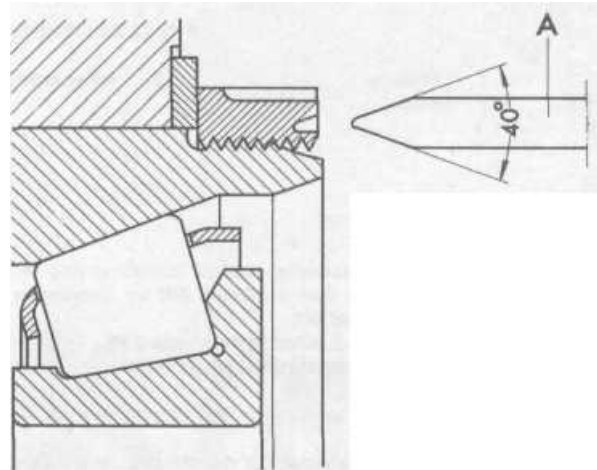


FIG. 12.22 PINION DRIVESHAFT NUT STAKING DIAGRAM

A Staking tool

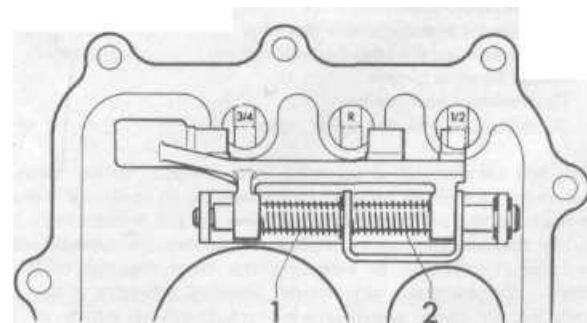
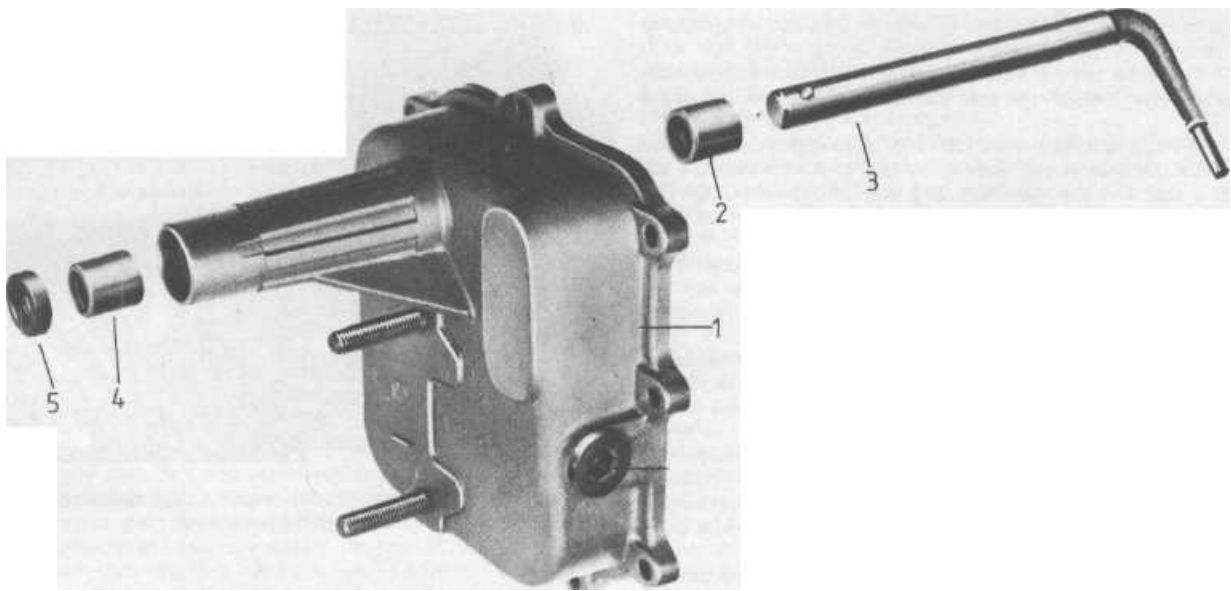


FIG.12.23 INTERMEDIATE SELECTOR LEVER SPRING ARRANGEMENT

1 Weaker spring

2 Stronger spring



**FIG. 12.24 GEARSHIFT HOUSING COMPONENTS**

1 Housing  
2 Bush

3 Inner selector lever

4 Spacer

Seal

121 Set the left-hand differential bearing adjusting ring to its originally marked position (see paragraph 54) by screwing it in the turn which it was backed off.

122 Refit the components detailed in paragraph 116.

123 Fit the drive flanges, the thrust washers and using a piece of tubing, drive on new circlips.

124 Fit new plastic sealing caps to the centres of the drive flanges.

125 Refer to Chapter 4 for details of the clutch release mechanism and refit the components.

126 The gearbox may be filled with oil now or after the unit is fitted in the vehicle.

127 If any of the following components have been renewed then the final drive will require adjusting and setting up by your VW dealer.

*Transmission case*

*Differential tapered roller bearings*

*Pinion bearing (double tapered roller)*

*Pinion bearing circlip*

*Crownwheel and pinion*

*Differential carrier or cover plate*

128 The differential is adjusted in two ways: (i) by shims at the pinion driveshaft tapered roller bearing to control the depth of mesh of the pinion teeth with those of the crownwheel, and (ii) by threaded adjusting rings at the differential tapered roller bearings. Tightening or releasing the rings has the effect of moving the complete differential housing sideways within the transmission case, again altering the meshing depth of the crownwheel and pinion teeth.

129 Without the special tools and gauges which your dealer will have for this work, it is virtually impossible to carry out adjustments which will not only cause noisy operation of the final drive but will also rapidly wear the transmission components.

*Type 091 manual gearbox (January 1976 on) - lubrication*

130 Commencing January 1976, this type of gearbox is 'filled for life' and periodic oil changes are not required.

131 A larger magnet is fitted to the drain plug to ensure that the lubricant is kept free from swarf now that oil changing is no longer required.

8 Braking system

*Disc calipers (Girling type)*

1 As from September 1975, Girling disc brake calipers are fitted as an alternative to the Teves type.

2 Pads should be inspected regularly and renewed if their friction material has worn down to 0.08 in (2.0 mm).

3 To renew the pads, remove the roadwheel, extract the spring clips from the ends of the pins and tap out the pins with a thin drift.

4 Remove the spring plate and pull the pads from the caliper gripping them with a pair of pliers if necessary.

5 On the back of each pad is an anti-squeal shim. Note that the directional arrow points upwards.

6 In order to accept the new thicker pads, the caliper pistons will have to be depressed fully into their cylinder bores. Use a flat bar such as a tyre lever to do this and anticipate a rise in the reservoir fluid level by syphoning some fluid out before depressing the pistons.

7 Insert the pads (friction lining against the disc) the anti-squeal shims and insert the pins and spring clips.

8 Apply the footbrake hard several times to position the pads against the disc.

9 Overhaul of a Girling caliper follows very closely the operations described in Chapter 8, Section 7 for the Teves type. Never attempt to release the bolts which hold the two halves



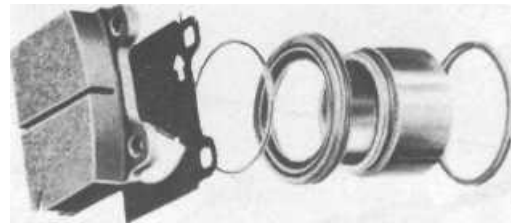
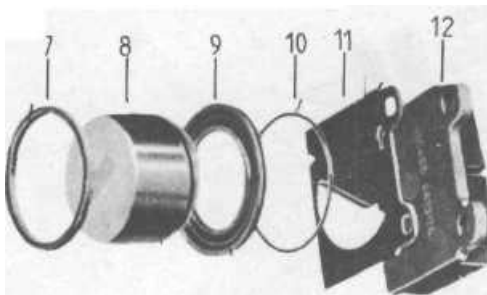
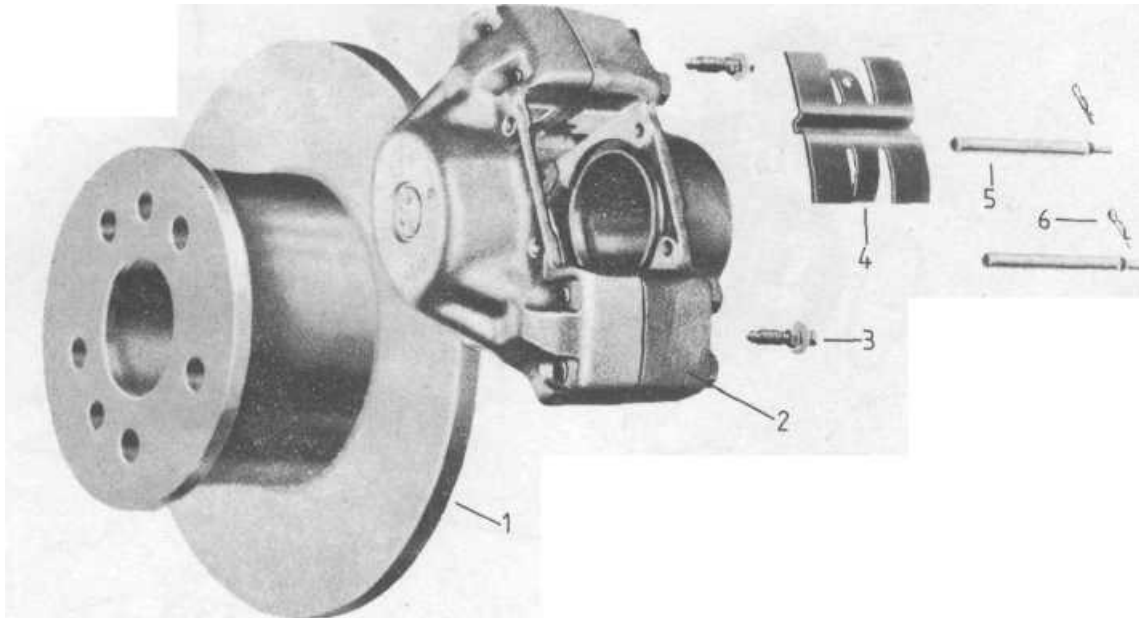


FIG.12.25 GIRLING TYPE CALIPER

1	Disc/hub	4	Anti-rattle spring	7	Piston seal	10	Retaining ring
2	Caliper body	5	Pad retaining pin	8	Piston	11	Anti-squeal shim
3	Bleed screw	6	Pin securing clip	9	Dust excluder	12	Friction pad

of the caliper together. If fluid is seen to be leaking from the joint, renew the caliper complete.

10 Girling and Teves calipers can be interchanged but only in pairs on the same axle.

#### Master cylinder

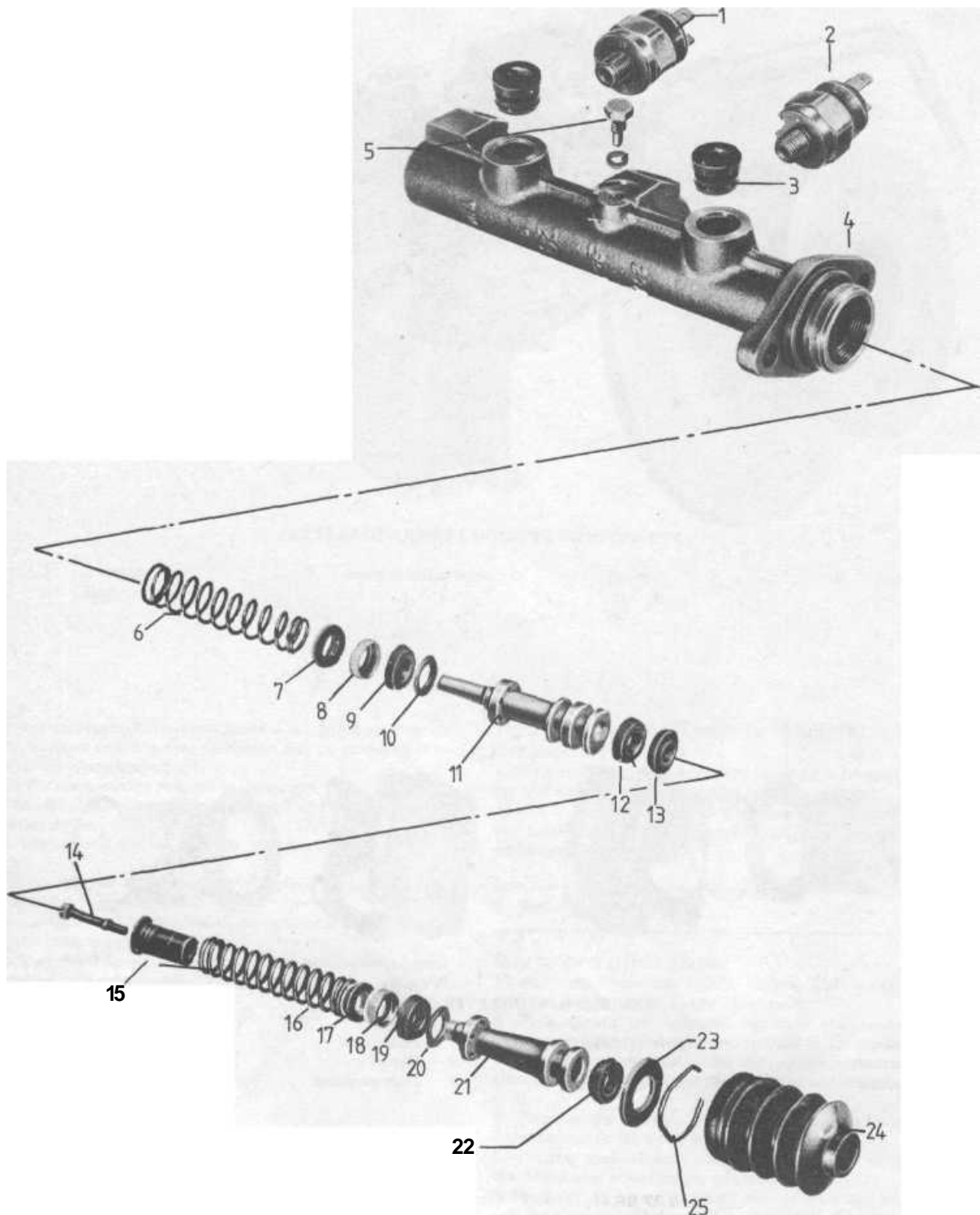
11 On later models, the master cylinder used in conjunction with a vacuum servo differs in detail from that used on systems without servo assistance.

12 Overhaul is similar with both types of cylinder.

#### 9 Electrical system

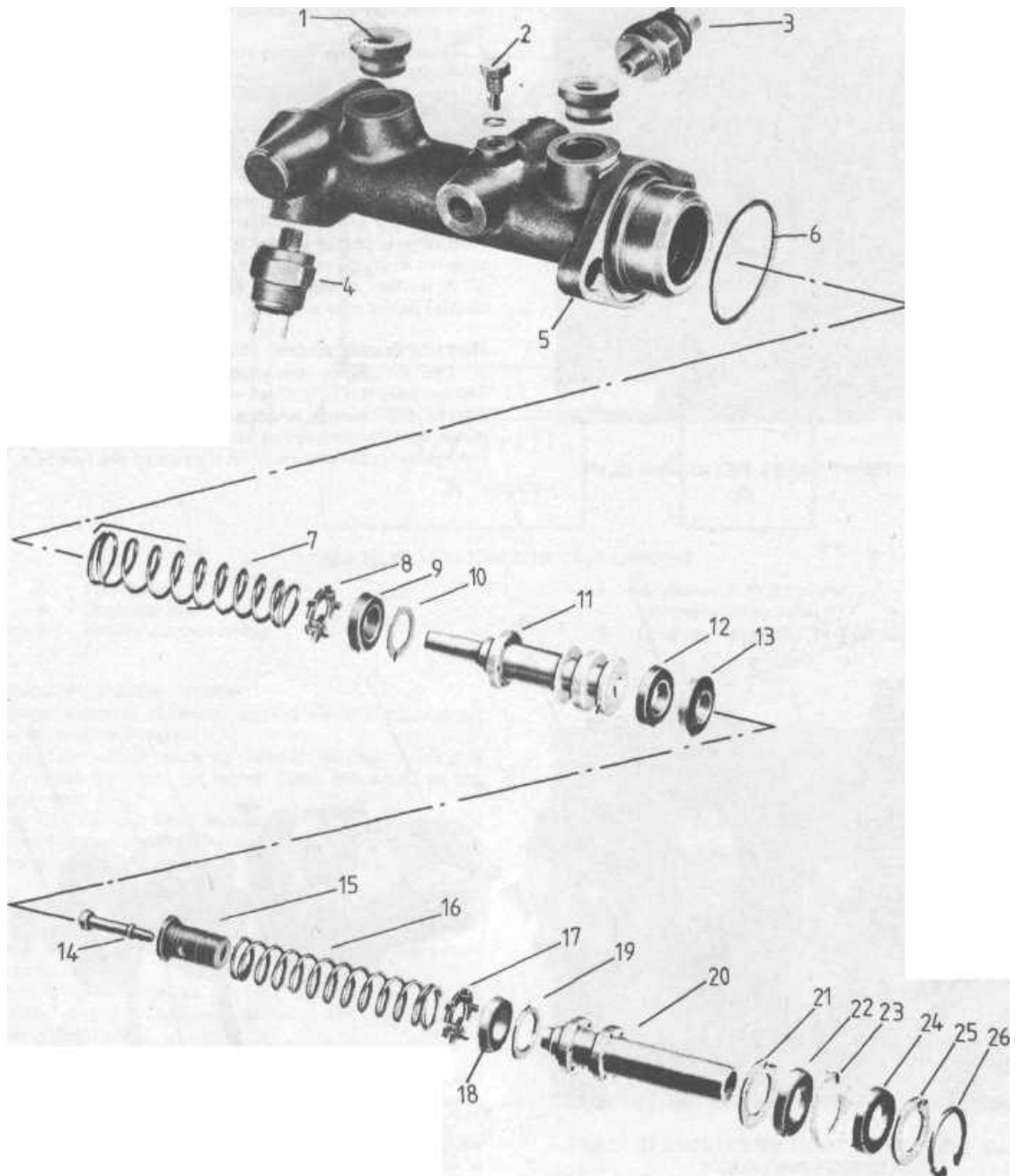
##### Instrument panel (August 1974 on) - removal and refitting

- 1 Disconnect the battery.
- 2 Pull the knobs from the heater and ventilator control levers.
- 3 Unscrew the instrument panel securing screws a few turns but do not remove them completely and then reach behind



**FIG.12.26 BRAKE MASTER CYLINDER (WITHOUT SERVO)**

1	Stop lamp switch	8	Washer	15	Stop sleeve	22	Cup seal
2	Stop lamp switch	9	Cup seal	16	Spring	23	Stop washer
3	Sealing plug	10	Cup washer	17	Support ring	24	Dust excluding boot
4	Master cylinder body	11	Secondary piston	18	Washer	25	Circlip
5	Stop bolt	12	Piston seal	19	Cup seal		
6	Spring	13	Piston seal	20	Cup washer		
7	Support ring	14	Stroke limiting screw	21	Primary piston		



**FIG.12.27 BRAKE MASTER CYLINDER (WITH SERVO)**

1	Plug	8	Support ring	15	Stop sleeve	22	Cup seal
2	Stop bolt	9	Cup seal	16	Spring	23	Plastic washer
3	Stop lamp switch	10	Cup washer	17	Support ring	24	Cup seal
4	Stop lamp switch	11	Secondary piston	18	Cup seal	25	Washer
5	Master cylinder body	12	Piston seal	19	Support ring	26	Circlip
6	Sealing ring	13	Piston seal	20	Primary piston		
7	Spring	14	Stroke limiting screw	21	Washer		

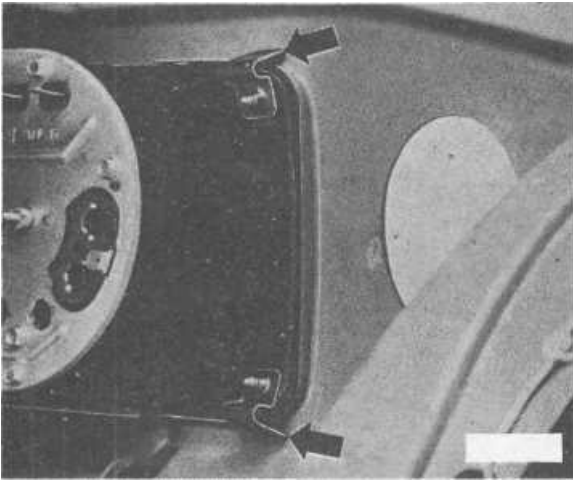


FIG.12.28 INSTRUMENT PANEL RETAINING CLIPS

the panel and twist the panel securing clips until the panel can be drawn forward far enough for the speedometer cable to be disconnected.

4 Disconnect the wiring having first identified the wires and terminals.

5 Remove the instrument voltage stabiliser or individual instruments as necessary.

#### *Heated rear window*

6 The heated rear window circuit incorporates a temperature control relay within the engine compartment.

7 Treat the conductive element carefully by not scratching it with objects placed against it or with rings on the fingers when cleaning it. Avoid sticking labels across the elements.

8 A broken element can be repaired using one of the conductive paints now available.

#### *Warning buzzer system (North America)*

9 This is fitted to later models as a reminder that the ignition key has been left in the lock when the door is opened.

10 The door switch, when actuated by opening the door, completes an electrical circuit to a buzzer which is located beside the headlamp dimmer relay on the rear of the fuse box.

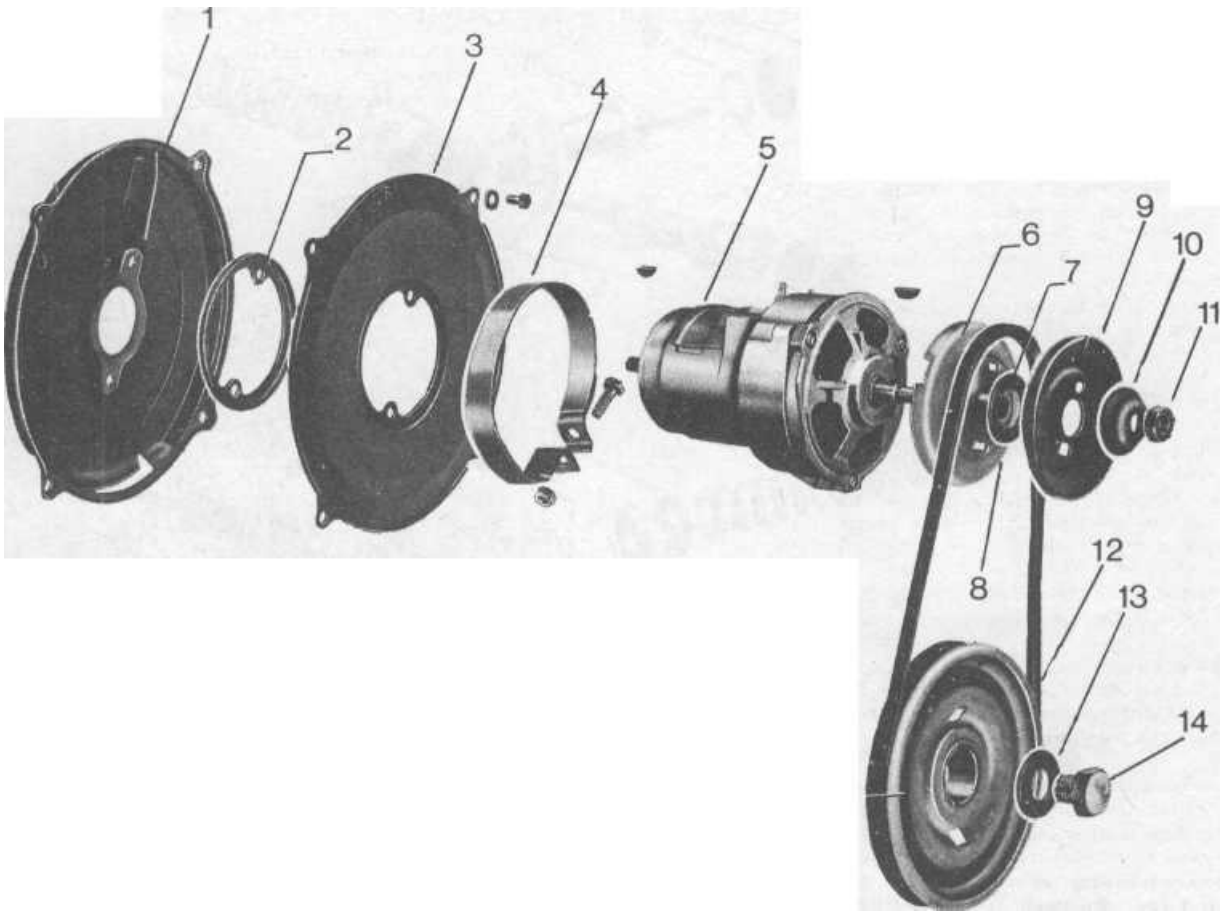


FIG.12.29 ALTERNATOR AND MOUNTING COMPONENTS

1 Inner fan cover  
2 Stiffener  
3 Outer fan cover  
4 Mounting strap

5 Alternator  
6 Pulley section  
7 Drivebelt  
8 Spacer (tension adjusting)

9 Pulley section  
10 Washer  
11 Nut  
12 Crankshaft pulley

13 Washer  
14 Retaining bolt

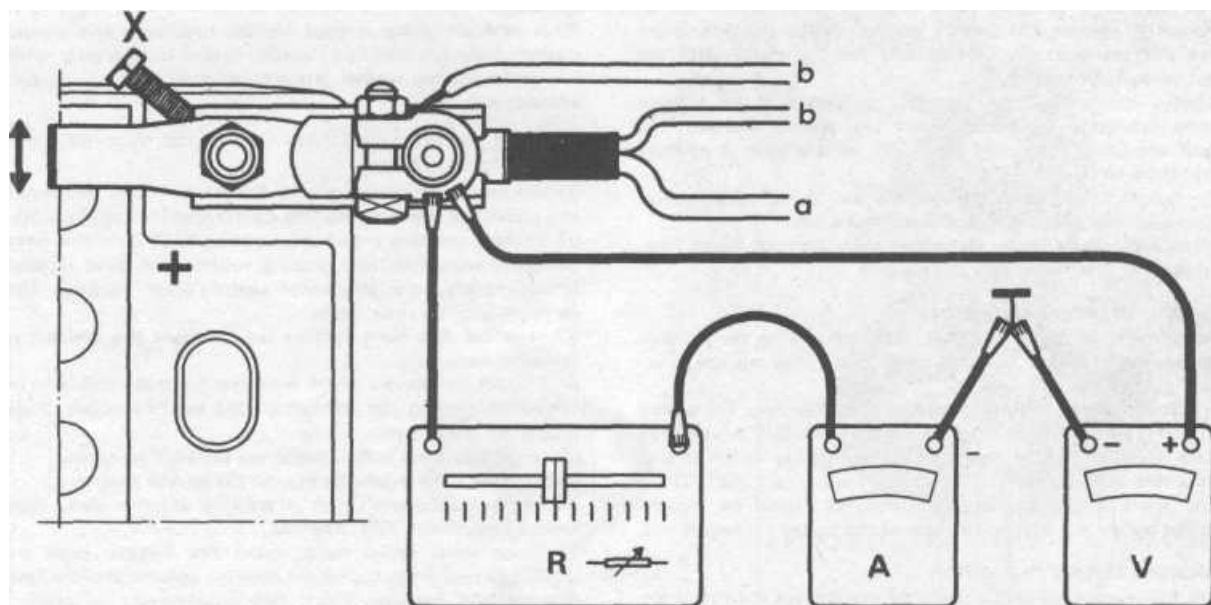


FIG.12.30 ALTERNATOR TEST CIRCUIT

a - To starter  
 b - Diagnosis leads  
 X - Battery cut-out switch

A - Ammeter (0 to 50 amps)  
 V - Voltmeter 10 to 18V  
 R - Load resistance (0.2 to 2 ohms/50 amp)

#### Speedometer drive cable - renewal

11 The speedometer is driven through a flexible cable from the left-hand front roadwheel.

12 To renew the cable, reach up behind the dashboard and unscrew the knurled ring nut which holds the cable to the speedometer head.

13 Remove the left-hand front hub cap and prise off the circlip or extract the cotter pin (according to type) from the square end of the cable at its projection from the hub bearing dust cover.

14 Reaching behind the roadwheel, pull the cable assembly from the steering stub axle carrier.

15 Pull the complete cable out through the aperture below the dashboard.

16 Refitting is the reversal of removal, but do not bend the cable sharply during installation or leave any sharp curves in the cable when fitted.

#### Alternator - description and precautions

17 On later models an alternator is fitted instead of the previous dynamo.

18 The alternator has a stator wound with coils which are connected to diodes in the endplate. Further diodes are also in the circuit and these are for the supply of current to the rotor on which are the field windings. The current goes via the slip rings.

19 The rotor has the field winding surrounded by two iron claws, and the alternator is nearly self-exciting.

20 The rotor shaft is supported in a ball race at the slip ring end and a plain bush bearing at the other, the bearings being carried in the endplates. The drive pulley is fitted to the rotor shaft on the outside of the endplate with the plain bush and secured with a nut and washer.

21 The other endplate carries the diodes in two heat sinks, or holders, designed to conduct the heat away from the diodes.

22 Since the diodes allow the passage of electric current in one direction only the need for a "cut-out" is obviated.

23 However, the unit requires a voltage regulator which is mounted on the alternator. Because the rotor is small there is not enough residual magnetism to excite the stator windings

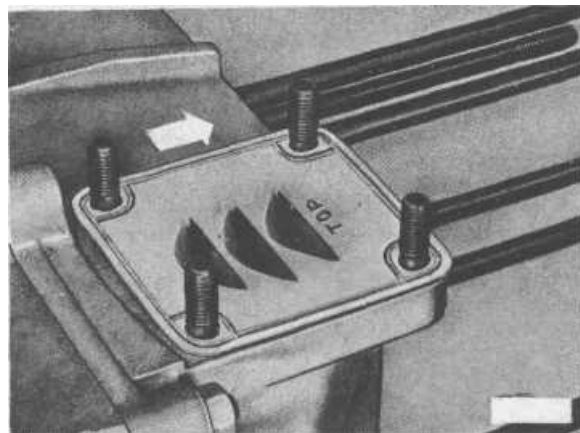


FIG.12.31 DEFLECTOR AT BASE OF ALTERNATOR MOUNTING PEDESTAL

at first and a small current is supplied via the ignition switch and terminal 'B+/61', the regulator and terminal 'DF' on the generator from the battery. Once excitation starts the machine becomes self-exciting, current being supplied by the stator to the excitation diodes and thence rectified to the slip rings and field winding.

24 The unit is cooled by the engine fan. Because the weight of the rotor is small and the slip ring diameter and weight much less than that of a commutator of a comparable DC generator it is possible to run the machine at much higher speeds than the DC generator would allow. This is one of the inherent advantages for the alternator gives a high charging current at low engine speeds and so keeps the battery charged even when driving in city traffic.

25 The alternator systems use a negative earth. Care must be taken not to reverse the battery connection or damage to the diodes will be extensive. Never run the alternator with the output wire disconnected.

26 Always disconnect the battery completely if an outside charging operation is contemplated (eg; trickle charge). Disconnect the battery and the alternator output wire if welding is being done to the car.

27 Do not use test connections which can 'short' accidentally. The fuses will not blow, the diodes will burn out.

28 When replacing a faulty alternator clear external faults first, or yet another alternator may be required.

#### *Alternator drivebelt - adjustment*

29 Adjustment of the drivebelt is made by varying the number of spacers between the two halves of the pulley on the alternator.

30 To dismantle the pulley, unscrew the pulley nut. The pulley can usually be prevented from rotating if the two runs of the belt are pinched tightly together but a locking notch is also incorporated in the pulley.

31 Any spare spacer washers not required should be located under the pulley nut against the face of the pulley for future use.

#### *Alternator - testing in position*

32 The following tests should only be carried out if an accurate voltmeter, ammeter and load resistance are available, also a tachometer.

33 To check the serviceability of the alternator and the voltage regulator carry out the following operations.

34 Disconnect the battery earth lead from the body and the positive lead from the battery.

35 Disconnect the battery cut-out switch from the battery positive terminal and then connect the battery positive lead to the cut-out switch which should then be moved to the 'ON' position.

36 Connect the ammeter, the voltmeter and the load resistance as shown in the diagram (Fig.12.30). Connect the tachometer in accordance with the maker's instructions.

37 Reconnect the battery earth strap to the body.

38 Start the engine and run it at 3000 rpm at the same time adjusting the load resistance until a reading of 20 amps is shown on the ammeter.

39 Open the battery cut-out switch which will separate the battery from the test circuit and determine the load current by means of the load resistance only.

40 Adjust the load resistance until 30 amps is shown on the ammeter. The voltage shown on the voltmeter should now be between 12.5 volts and 14.5 volts.

41 If readings deviate from those specified, renew the voltage regulator.

42 If on retesting with the new voltage regulator fitted, the readings still do not comply with those specified, then the alternator is faulty.

#### *Alternator - removal and refitting*

43 Disconnect the battery and the leads from the alternator.

44 The removal and refitting operations are now almost identical with those described for the dynamo in Chapter 2, Section 4.

45 If for any reason the alternator mounting pedestal is removed, make sure that when refitting it that the deflector plate has the word 'TOP' visible and towards the cylinder head.

#### *Alternator - overhaul*

46 Major overhaul of the alternator is not recommended due to the difficulty in obtaining individual spare parts. A new or factory reconditioned unit is to be preferred.

47 Renewal of the carbon brushes may be undertaken if after a high mileage they have worn down to 0.2 in (5.0 mm) or less. Remove the cover plate for access.

#### *Headlamp washers*

48 On later models, an optional headlamp washer system is

available.

49 A separate pump is used for the headlamp and windscreen washers although the fluid reservoir is common to both systems.

50 The headlamp washer jets are mounted in the front bumper overriders.

#### *Steering column switches and lock (up to 1974) - removal and refitting*

51 Disconnect the battery and the horn wire at the connector just above the flexible coupling on the steering column tube.

52 Extract the two crosshead screws which hold the direction indicator switch to the steering column and then remove the screws which hold the wiper switch (later models). Let the switches hang by their leads.

53 Prise off the horn button and unscrew the steering wheel retaining nut.

54 Extract the screws which hold the direction indicator switch cancelling ring to the bottom of the steering wheel. Slide the ring down the column.

55 Using a suitable puller, withdraw the steering wheel.

56 Remove the insulating ring, the circlip and washer.

57 On cars equipped with a steering column lock, turn the key to the ignition 'ON' position.

58 Brush some brake fluid round the flexible bush that is located between the top of the steering column and the ignition/steering lock housing. Using two screwdrivers as levers, prise the flexible bush from the column and lock.

59 On later vehicles, bleed the air from the windscreen washer reservoir and disconnect the washer hoses from the washer valve.

60 Working behind the instrument panel, disconnect the leads from the direction indicator switch, and wiper switch which were left hanging, also the leads from the ignition switch.

61 Extract the crosshead screws which hold the lock housing and slide it up and off the steering column.

62 Extract the small securing screw and detach the ignition/starter switch from the lock body. On later models, the lock is detachable from the lock housing by extracting two screws. On earlier models, the components are made as one unit.

63 Refitting is a reversal of removal but make sure that the screws which hold the lock housing to the column mounting bracket are tightened to only 11 lbf ft (1.5 kgf m) otherwise the energy absorbing steering column will not collapse in the event of impact.

64 Fit the steering wheel so that the spokes are horizontal when the front roadwheels are in the straight ahead position. Tighten the steering wheel nut to 20 lbf ft (2.7 kgf m).

65 When installing the direction indicator and wiper/washer switches on later models, ensure that there is a gap of 0.080 in (2.0 mm) between the switch housing and the steering wheel.

#### *Steering column switches and lock (1975 on) - removal and refitting*

66 Disconnect the battery and bleed all air pressure from the windscreen washer fluid reservoir.

67 Prise the horn button from the centre of the steering wheel, remove the securing nut and with the aid of a suitable puller, withdraw the wheel.

68 Remove the spring and spacer from the upper end of the steering column.

69 Extract the screws and release the direction indicator and wiper switches from their mounting lugs on the steering lock housing. Note the location of the distance pieces.

70 Disconnect the washer hose from the valve on the wiper switch and then disconnect the leads from the direction indicator and wiper switches.

71 Remove the switch upper trim from the steering column.

72 Working through the hole provided in the lower portion of the switch housing trim, drill a hole in the centre of the lock shear bolt. Using an 'easy out' or similar bolt extractor, unscrew and remove the shear bolt.

73 Using the ignition key, unlock the steering column lock.

74 Extract the two crosshead screws which hold the switch

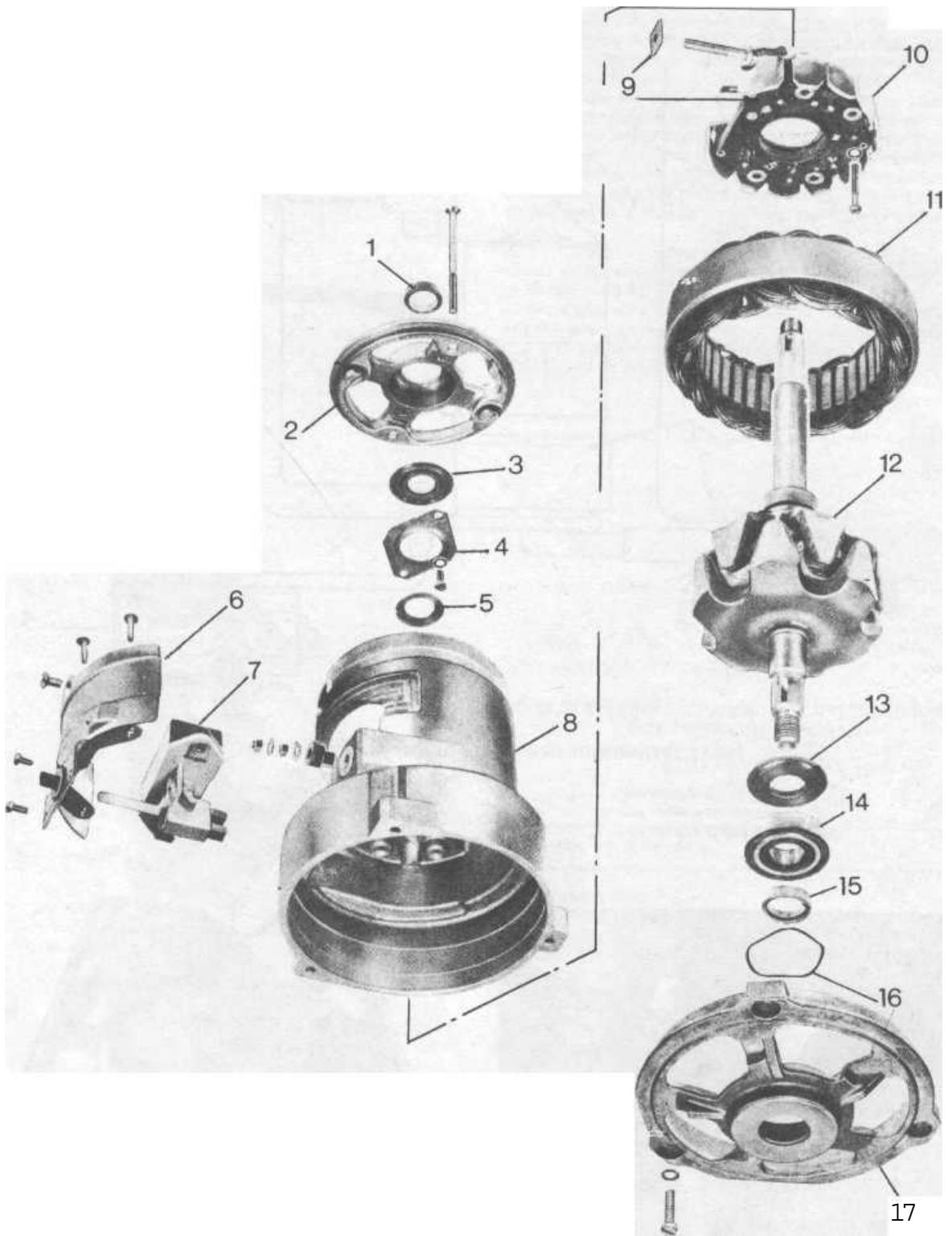
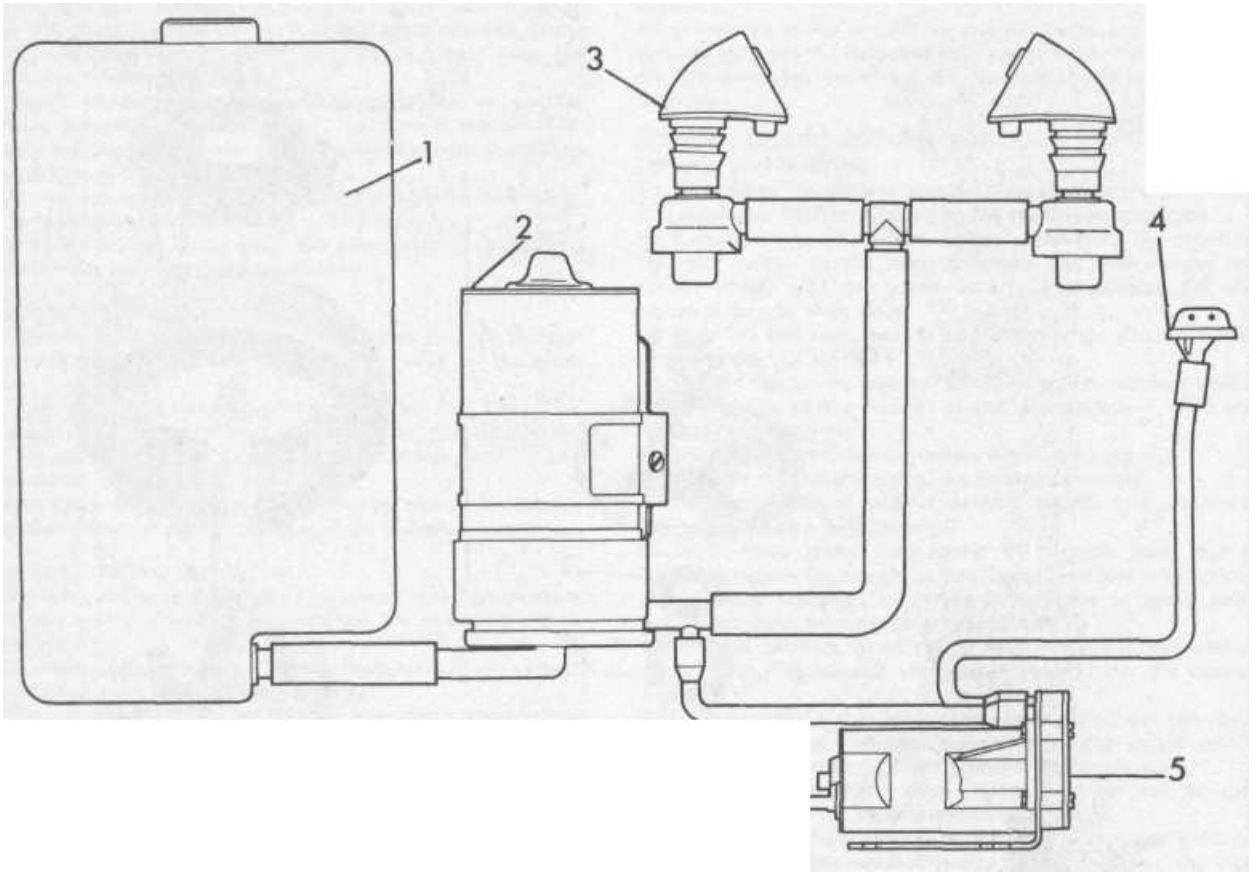


FIG.12.32 EXPLODED VIEW OF THE ALTERNATOR

- |   |                  |   |                          |    |                |    |                 |
|---|------------------|---|--------------------------|----|----------------|----|-----------------|
| 1 | Spacer           | 6 | Cover plate              | 10 | Diode assembly | 15 | Spacer          |
| 2 | Fan end plate    | 7 | Regulator/brush assembly | 11 | Stator         | 16 | Spring          |
| 3 | Bearing          | 8 | Body                     | 12 | Rotor          | 17 | Drive end plate |
| 4 | Bearing retainer | 9 | Insulating plate         | 13 | Washer         |    |                 |
| 5 | Washer           |   |                          | 14 | Bearing        |    |                 |

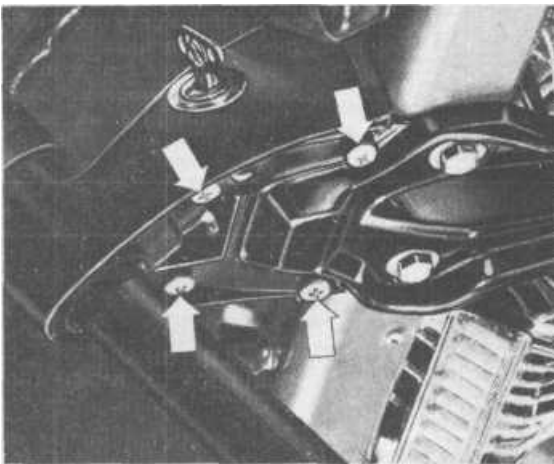




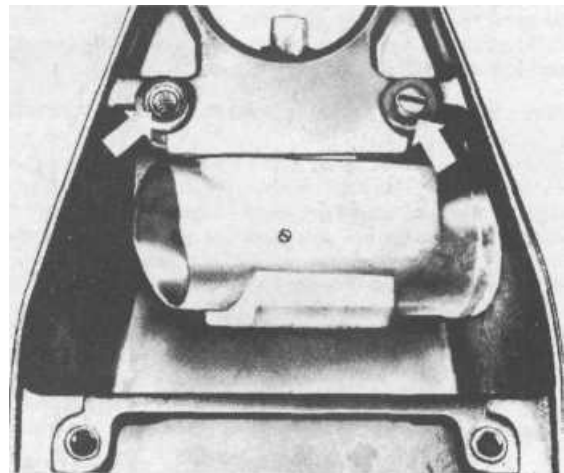
**FIG.12.33 WINDSCREEN AND HEADLAMP WASHER SYSTEM**

- 1 Washer fluid reservoir*
- 2 Headlamp washer pump*
- 3 Headlamp washer jets*

- 4 Windscreen washer jets*
- 5 Windscreen washer pump*



**FIG.12.34 STEERING COLUMN LOCK HOUSING SECURING SCREWS**



**FIG.12.35 STEERING COLUMN LOCK (TO HOUSING) SCREWS ON LATER MODELS**

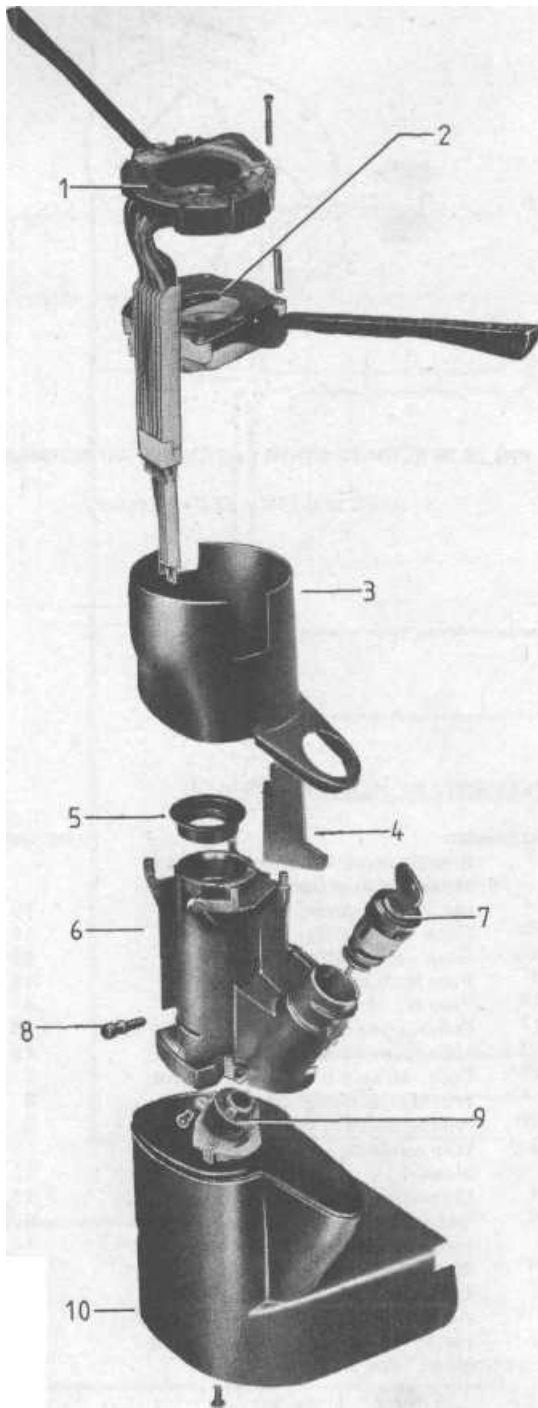


FIG.12.36 STEERING COLUMN LOCK AND SWITCHES (1975 ON)

- |   |                            |    |                          |
|---|----------------------------|----|--------------------------|
| 1 | Direction indicator switch | 7  | Lock cylinder            |
| 2 | Wiper switch               | 8  | Lock spear head screw    |
| 3 | Column/switch upper trim   | 9  | Ignition switch          |
| 4 | Cover plate                | 10 | Column/switch lower trim |
| 5 | Spacer                     |    |                          |
| 6 | Switch/lock housing        |    |                          |

- housing lower trim to the base of the steering lock housing.
- 75 Remove the lock by sliding it up and off the steering column.
- 76 The ignition switch can be detached from the steering lock housing once the small securing screw is extracted.
- 77 To remove the lock cylinder, pull the lock cover plate out of the housing using a pair of pliers. A small hole will now be exposed into which a probe should be inserted to depress the spring which will enable the cylinder to be withdrawn. On some late models this hole may have to be drilled in accordance with the diagram. Use a 1/8 in (3.0 mm) diameter drill (Fig.12.37).
- 78 Refitting is a reversal of removal but observe the following points.
- 79 Fit the steering wheel with spokes horizontal and front roadwheels in the straight ahead position. Tighten the retaining nut to 36 lbf ft (4.9 kgf m).
- 80 Set a clearance between the base of the steering wheel hub and the direction indicator switch of between 0.063 and 0.13 in (2.0 and 3.0 mm) before tightening a new lock shear bolt and breaking off its head.

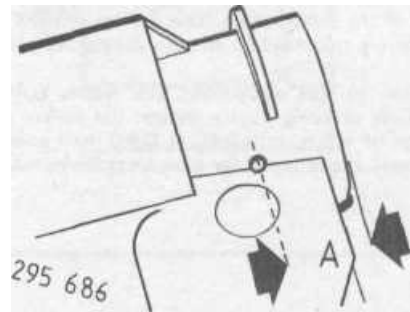


FIG.12.37 STEERING COLUMN LOCK CYLINDER RELEASE HOLE DRILLING DIAGRAM

a 0.51 in (13.0 mm)

## 10 Steering and suspension

### Rear torsion bars

- 1 On vehicles produced from August 1974, the torsion bars have different numbers of splines on their inner and outer ends. The inner end has 48 splines and the outer end 52 splines.
- 2 Turning one spline of the inner end alters the torsion bar setting angle 7° 30'. Turning the spring plate one spline in the opposite direction alters the angle 6° 55'. The result of this is that the smallest alteration in angle which can be achieved is 0° 35'.
- 3 To carry out the adjustment, fit the spring plate to the torsion bar and using a protractor, measure the angle as described in Chapter 10, Section 10.
- 4 Any deviation in excess of 0° 35' from the specified setting angle should be corrected. To do this, either move the torsion bar on one spline and the spring plate back one spline or in the reverse sequence.

### Steering gear roller shaft oil seal - renewal

- 5 A defective oil seal (see Fig.10.6) can be renewed on vehicles built after 1972 in the following way.
- 6 Mark the relative position of the steering drop arm to the roller shaft, flatten the tab of the lockplate and unscrew the retaining nut. With a suitable puller, remove the drop arm.
- 7 Using a very sharp probe, tap it through the oil seal and lever it out. Take care not to damage the roller shaft or housing during this operation.
- 8 Wipe out the oil seal recess and tape over the splines of the

roller shaft to prevent them cutting the lips of the oil seal as it is fitted.

9 Apply grease to the lips of the seal and drive it into position using a piece of tubing.

10 Refit the drop arm, correctly aligned, fit a new lockplate and tighten the nut to a torque wrench setting of 104 lbf ft (14.0 kgf m). Bend up the tab of the lockplate.

11 Check and top up the oil level in the steering box.

**11 Bodywork**

*Sliding door adjustment (Chassis No 214 2000 001 on)*

1 If excessive force is needed to close the sliding door, the following adjustment may reduce the effort required.

2 Move the striker plate for the centre lock outwards between 0.04 and 0.08 in (1.0 and 2.0 mm).

3 The vertical movement of the striker plate is correct if when the door is closed, there is a gap of between 0.08 and 0.12 in (2.0 and 3.0 mm) between the opened rotary latch and the locking pin of the striker plate. This can be verified by holding a strip of correct thickness on the pin during the gentle closure of the door.

4 In addition to this adjustment, the rubber buffers on the lock should be pressing lightly against the striker plate when the rear edge of the door is 0.60 in (15.0 mm) away from the body side panel. If this is not the case, fit shims to rectify.

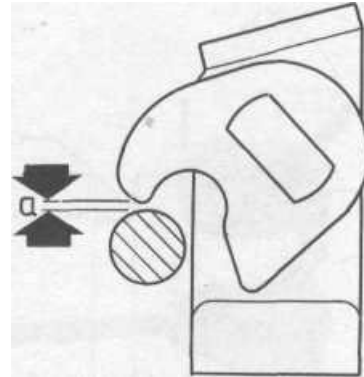


FIG.12.38 SLIDING DOOR LATCH/PIN ADJUSTMENT

a 0.078 to 0.118 in (2.0 to 3.0 mm)

FIG. 12.39 KEY TO WIRING DIAGRAM. SUPPLEMENTARY HEATER - 1974 ON

Designation	In current track	Designation	In current track
B*	To starter terminal 30	1	
D+	To voltage regulator	2	
E1a	Terminal 58b remains vacant	3	
E13	Temperature regulating switch (switch part)	5	
Ei3a	Temperature regulating switch (regulating part)	6	
Ei3b	Temperature regulating switch (electronic circuit)	6,7	
E16	Main switch	8	
F16	Thermo-switch	14	
F17	Overheating	17	
G6	Fuel pump	16	
j8a	Relay	7, 14, 16	
j8b	Relay	8,9, 15	
j8c	Relay	8, 15	
ji0	Safety switch	8,10	
ji2*	Relay for warm air blower	1,2	
K11	Warning lamp	5	
N10	Temperature sensor	6	
N11	Ignition coil	13	
01	Breaker contact in combustion air blower for coil (one impulse per revolution)	13	
O^	Breaker contact in combustion air blower for fuel pump (one impulse per 33 revolutions)	16	
Q5a	Glow - spark plug - Glow element	11	
Q^b	Glow - spark plug - Electrode	12	
s9	Fuse No 9 in fuse box	16	
S1°	Fuse No 10 in fuse box	4	
S1?	Overheating fuse - 8 amp (separate fuse)	16	
S23	Main fuse - 16 amp (separate fuse)	15	
S25*	Fuse - 16 amp for warm air blower	1	
T	Wire connector (under dash)	8	
Tib	v\j <sub>re</sub> connector, single (under dash)	8	
T^	Wire connector, double (on warm air blower)	1	
T^	Connector on combustion air blower	13, 14, 16	
T8	Connector, 8 point (on holder for water container)	5, 6, 11, 14, 16	
V4*	Warm air blower	1	
V6	Combustion air blower	14	
V10	Air circulation blower	15	
18	Heater earth screw on coil bracket	11,15,17	

\*Not fitted to Type 2 1600

Pin colour key explanation

ro = red	br = brown
sw = black	ws = white
ge = yellow	gn = green
bl = blue	gr = grey

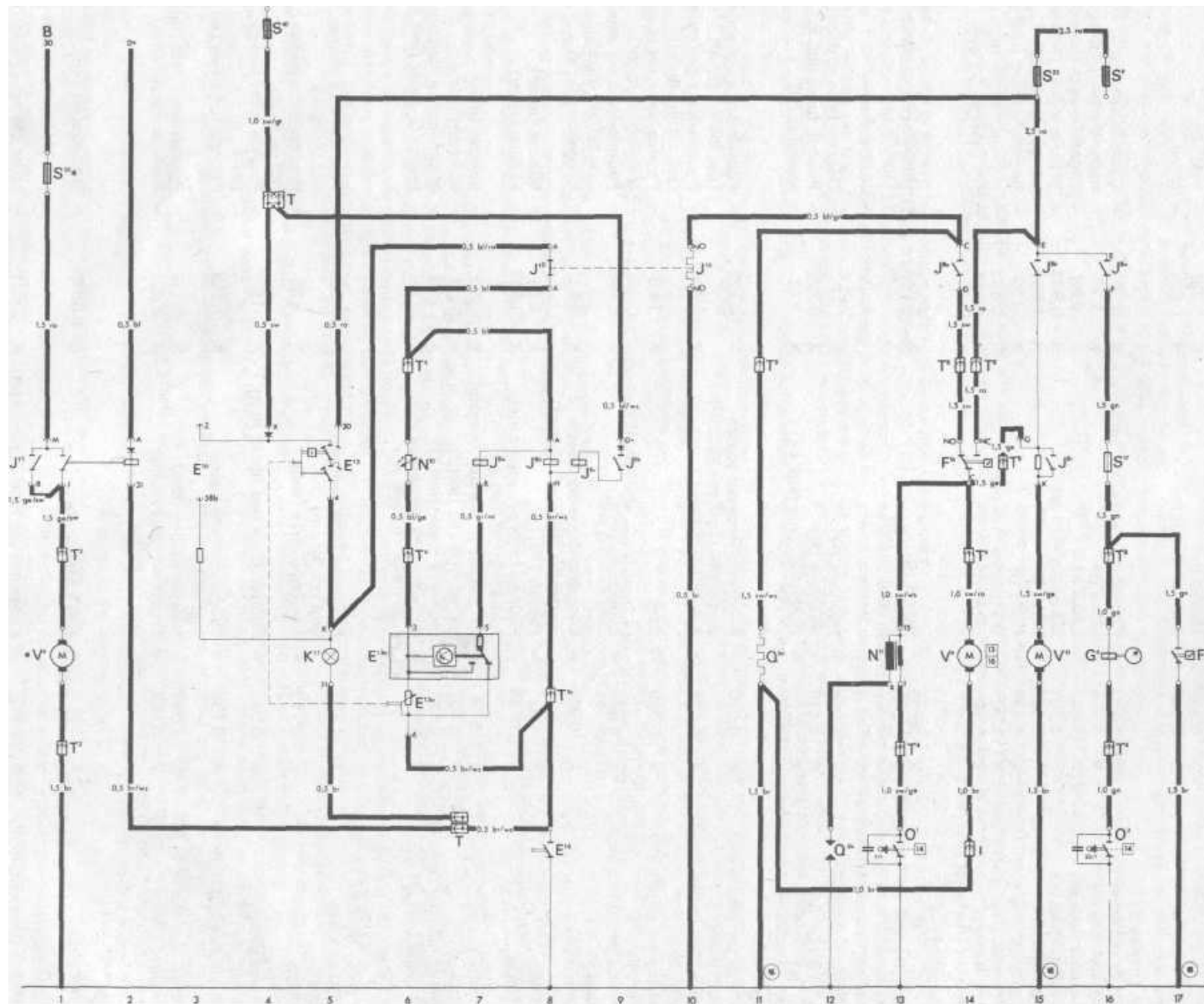


FIG. 12.39 WIRING DIAGRAM FOR SUPPLEMENTARY HEATER - 1974 ON

# Conversion factors

Inches (in)	X	25.4	=	Millimetres (mm)	X	0.0394	=	Inches (in)
Feet (ft)	X	0.305	=	Metres (m)	X	3.281	=	Feet (ft)
Miles	X	1.609	=	Kilometres (km)	X	0.621	=	Miles
<i>Volume (capacity)</i>								
Cubic inches (cu in; in <sup>3</sup> )	X	16.387	=	Cubic centimetres (cc; cm <sup>3</sup> )	X	0.061	=	Cubic inches (cu in; in <sup>3</sup> )
Imperial pints (Imp pt)	X	0.568	=	Litres (l)	X	1.76	=	Imperial pints (Imp pt)
Imperial quarts (Imp qt)	X	1.137	=	Litres (l)	X	0.88	=	Imperial quarts (Imp qt)
Imperial quarts (Imp qt)	X	1.201	=	US quarts (US qt)	X	0.833	=	Imperial quarts (Imp qt)
US quarts (US qt)	X	0.946	=	Litres (l)	X	1.057	=	US quarts (US qt)
Imperial gallons (Imp gal)	X	4.546	=	Litres (l)	X	0.22	=	Imperial gallons (Imp gal)
Imperial gallons (Imp gal)	X	1.201	=	US gallons (US gal)	X	0.833	=	Imperial gallons (Imp gal)
US gallons (US gal)	X	3.785	=	Litres (l)	X	0.264	=	US gallons (US gal)
<i>Mass (weight)</i>								
Ounces (oz)	X	28.35	=	Grams (g)	X	0.035	=	Ounces (oz)
Pounds (lb)	X	0.454	=	Kilograms (kg)	X	2.205	=	Pounds (lb)
<i>Force</i>								
Ounces-force (ozf; oz)	X	0.278	=	Newtons (N)	X	3.6	=	Ounces-force (ozf; oz)
Pounds-force (lbf; lb)	X	4.448	=	Newtons (N)	X	0.225	=	Pounds-force (lbf; lb)
Newtons (N)	X	0.1	=	Kilograms-force (kgf; kg)	X	9.81	=	Newtons (N)
<i>Pressure</i>								
Pounds-force per square inch (psi; lbf/in <sup>2</sup> ; lb/in <sup>2</sup> )	X	0.070	=	Kilograms-force per square centimetre (kgf/cm <sup>2</sup> ; kg/cm <sup>2</sup> )	X	14.223	=	Pounds-force per square inch (psi; lbf/in <sup>2</sup> ; lb/in <sup>2</sup> )
Pounds-force per square inch (psi; lbf/in <sup>2</sup> ; lb/in <sup>2</sup> )	X	0.068	=	Atmospheres (atm)	X	14.696	=	Pounds-force per square inch (psi; lbf/in <sup>2</sup> ; lb/in <sup>2</sup> )
Pounds-force per square inch (psi; lbf/in <sup>2</sup> ; lb/in <sup>2</sup> )	X	0.069	=	Bars	X	14.5	=	Pounds-force per square inch (psi; lbf/in <sup>2</sup> ; lb/in <sup>2</sup> )
Pounds-force per square inch (psi; lbf/in <sup>2</sup> ; lb/in <sup>2</sup> )	X	6.895	=	Kilopascals (kPa)	X	0.145	=	Pounds-force per square inch (psi; lbf/in <sup>2</sup> ; lb/in <sup>2</sup> )
Kilopascals (kPa)	X	0.01	=	Kilograms-force per square centimetre (kgf/cm <sup>2</sup> ; kg/cm <sup>2</sup> )	X	98.1	=	Kilopascals (kPa)
Millibar (mbar)	X	100	=	Pascals (Pa)	X	0.01	=	Millibar (mbar)
Millibar (mbar)	X	0.0145	=	Pounds-force per square inch (psi; lbf/in <sup>2</sup> ; lb/in <sup>2</sup> )	X	68.947	=	Millibar (mbar)
Millibar (mbar)	X	0.75	=	Millimetres of mercury (mmHg)	X	1.333	=	Millibar (mbar)
Millibar (mbar)	X	0.401	=	Inches of water (inH <sub>2</sub> O)	X	2.491	=	Millibar (mbar)
Millimetres of mercury (mmHg)	X	0.535	=	Inches of water (inH <sub>2</sub> O)	X	1.868	=	Millimetres of mercury (mmHg)
Inches of water (inH <sub>2</sub> O)	X	0.036	=	Pounds-force per square inch (psi; lbf/in <sup>2</sup> ; lb/in <sup>2</sup> )	X	27.68	=	Inches of water (inH <sub>2</sub> O)
<i>Torque (moment of force)</i>								
Pounds-force inches (lbf in; lb in)	X	1.152	=	Kilograms-force centimetre (kgf cm; kg cm)	X	0.868	=	Pounds-force inches (lbf in; lb in)
Pounds-force inches (lbf in; lb in)	X	0.113	=	Newton metres (Nm)	X	8.85	=	Pounds-force inches (lbf in; lb in)
Pounds-force inches (lbf in; lb in)	X	0.083	=	Pounds-force feet (lbf ft; lb ft)	X	12	=	Pounds-force inches (lbf in; lb in)
Pounds-force inches (lbf in; lb in)	X	0.138	=	Kilograms-force metres (kgf m; kg m)	X	7.233	=	Pounds-force inches (lbf in; lb in)
Pounds-force feet (lbf ft; lb ft)	X	1.356	=	Newton metres (Nm)	X	0.738	=	Pounds-force feet (lbf ft; lb ft)
Newton metres (Nm)	X	0.102	=	Kilograms-force metres (kgf m; kg m)	X	9.804	=	Newton metres (Nm)
<i>Power</i>								
Horsepower (hp)	X	745.7	=	Watts (W)	X	0.0013	=	Horsepower (hp)
<i>Velocity (speed)</i>								
Miles per hour (miles/hr; mph)	X	1.609	=	Kilometres per hour (km/hr; kph)	X	0.621	=	Miles per hour (miles/hr; mph)
<i>Fuel consumption*</i>								
Miles per gallon, Imperial (mpg)	X	0.354	=	Kilometres per litre (km/l)	X	2.825	=	Miles per gallon, Imperial (mpg)
Miles per gallon, US (mpg)	X	0.425	=	Kilometres per litre (km/l)	X	2.352	=	Miles per gallon, US (mpg)

## Temperature

Degrees Fahrenheit = (°C x 1.8) + 32

Degrees Celsius; (Degrees Centigrade; °C) = (°F - 32) x 0.56

# Safety first!

Professional motor mechanics are trained in safe working procedures. However enthusiastic you may be about getting on with the job in hand, do take the time to ensure that your safety is not put at risk. A moment's lack of attention can result in an accident, as can failure to observe certain elementary precautions.

There will always be new ways of having accidents, and the following points do not pretend to be a comprehensive list of all dangers; they are intended rather to make you aware of the risks and to encourage a safety-conscious approach to all work you carry out on your vehicle.

## Essential DOs and DON'Ts

**DON'T** rely on a single jack when working underneath the vehicle. Always use reliable additional means of support, such as axle stands, securely placed under a part of the vehicle that you know will not give way.

**DON'T** attempt to loosen or tighten high-torque nuts (e.g. wheel hub nuts) while the vehicle is on a jack; it may be pulled off.

**DON'T** start the engine without first ascertaining that the transmission is in neutral (or 'Park' where applicable) and the parking brake applied.

**DON'T** suddenly remove the filler cap from a hot cooling system - cover it with a cloth and release the pressure gradually first, or you may get scalded by escaping coolant.

**DON'T** attempt to drain oil until you are sure it has cooled sufficiently to avoid scalding you.

**DON'T** grasp any part of the engine, exhaust or catalytic converter without first ascertaining that it is sufficiently cool to avoid burning you.

**DON'T** allow brake fluid or antifreeze to contact vehicle paintwork.

**DON'T** syphon toxic liquids such as fuel, brake fluid or antifreeze by mouth, or allow them to remain on your skin.

**DON'T** inhale dust - it may be injurious to health (see *Asbestos* below).

**DON'T** allow any spilt oil or grease to remain on the floor - wipe it up straight away, before someone slips on it.

**DON'T** use ill-fitting spanners or other tools which may slip and cause injury.

**DON'T** attempt to lift a heavy component which may be beyond your capability - get assistance.

**DON'T** rush to finish a job, or take unverified short cuts.

**DON'T** allow children or animals in or around an unattended vehicle.

**DO** wear eye protection when using power tools such as drill, sander, bench grinder etc, and when working under the vehicle.

**DO** use a barrier cream on your hands prior to undertaking dirty jobs - it will protect your skin from infection as well as making the dirt easier to remove afterwards; but make sure your hands aren't left slippery. Note that long-term contact with used engine oil can be a health hazard.

**DO** keep loose clothing (cuffs, tie etc) and long hair well out of the way of moving mechanical parts.

**DO** remove rings, wristwatch etc, before working on the vehicle - especially the electrical system.

**DO** ensure that any lifting tackle used has a safe working load rating adequate for the job.

**DO** keep your work area tidy - it is only too easy to fall over articles left lying around.

**DO** get someone to check periodically that all is well, when working alone on the vehicle.

**DO** carry out work in a logical sequence and check that everything is correctly assembled and tightened afterwards.

**DO** remember that your vehicle's safety affects that of yourself and others. If in doubt on any point, get specialist advice.

IF, in spite of following these precautions, you are unfortunate enough to injure yourself, seek medical attention as soon as possible.

## Asbestos

Certain friction, insulating, sealing, and other products - such as brake linings, brake bands, clutch linings, torque converters, gaskets, etc - contain asbestos. *Extreme care must be taken to avoid inhalation*

## Fire

Remember at all times that petrol (gasoline) is highly flammable. Never smoke, or have any kind of naked flame around, when work on the vehicle. But the risk does not end there - a spark caused by electrical short-circuit, by two metal surfaces contacting each other, careless use of tools, or even by static electricity built up in you or under certain conditions, can ignite petrol vapour, which in a confined space is highly explosive.

Always disconnect the battery earth (ground) terminal before working on any part of the fuel or electrical system, and never risk spilling fuel on to a hot engine or exhaust.

It is recommended that a fire extinguisher of a type suitable for fire and electrical fires is kept handy in the garage or workplace at all times. Never try to extinguish a fuel or electrical fire with water.

**Note:** Any reference to a 'torch' appearing in this manual should always be taken to mean a handheld battery-operated electric lamp flashlight. It does NOT mean a welding/gas torch or blowlamp.

## Fumes

Certain fumes are highly toxic and can quickly cause unconsciousness and even death if inhaled to any extent. Petrol (gasoline) vapour comes into this category, as do the vapours from certain solvents such as trichloroethylene. Any draining or pouring of such volatile fluids should be done in a well ventilated area.

When using cleaning fluids and solvents, read the instruction carefully. Never use materials from unmarked containers - they may give off poisonous vapours.

Never run the engine of a motor vehicle in an enclosed space such as a garage. Exhaust fumes contain carbon monoxide which is extremely poisonous; if you need to run the engine, always do so in the open air or at least have the rear of the vehicle outside the workplace.

If you are fortunate enough to have the use of an inspection pit never drain or pour petrol, and never run the engine, while the vehicle is standing over it; the fumes, being heavier than air, will concentrate in the pit with possibly lethal results.

## The battery

Never cause a spark, or allow a naked light, near the vehicle's battery. It will normally be giving off a certain amount of hydrogen gas, which is highly explosive.

Always disconnect the battery earth (ground) terminal before working on the fuel or electrical systems.

If possible, loosen the filler plugs or cover when charging the battery from an external source. Do not charge at an excessive rate or the battery may burst.

Take care when topping up and when carrying the battery. The acid electrolyte, even when diluted, is very corrosive and should not be allowed to contact the eyes or skin.

If you ever need to prepare electrolyte yourself, always add the acid slowly to the water, and never the other way round. Protect against splashes by wearing rubber gloves and goggles.

When jump starting a car using a booster battery, for negative earth (ground) vehicles, connect the jump leads in the following sequence: First connect one jump lead between the positive (+) terminals of the two batteries. Then connect the other jump lead first to the negative (-) terminal of the booster battery, and then to a good earthing (ground) point on the vehicle to be started, at least 18 in (45 cm) from the battery if possible. Ensure that hands and jump leads are clear of any moving parts, and that the two vehicles do not touch. Disconnect the leads in the reverse order.

## Mains electricity and electrical equipment

When using an electric power tool, inspection light etc, always ensure that the appliance is correctly connected to its plug and that, where necessary, it is properly earthed (grounded). Do not use such appliances in damp conditions and, again, beware of creating a spark or applying excessive heat in the vicinity of fuel or fuel vapour. Also ensure that the appliances meet the relevant national safety standards.

## Ignition HT voltage

A severe electric shock can result from touching certain parts of the ignition system, such as the HT leads, when the engine is running.

# Index

**Air cleaner** 58,197

**Air control flaps** - 48

## **Alternator**

adjustment- 214

description and precautions- 213

driveshaft-214

overhaul - 214

removal and refitting - 214

testing in position - 214

**Auxiliary heater** 52

**Axle, front, removal** 179

**Axle shafts**- 115

## **B**

### **Balljoint**

steering - 177

suspension - 169

### **Battery**

charging- 141

maintenance- 139

### **Big-ends**

assembly- 28

examination - 22

removal - 22

### **Bodywork and underframe**

door catches - 188

doors, hinged - 185

doors, sliding - 188,218

doors, window glass - 187

major and minor repairs - 183,185

maintenance- 182

### **Braking system**

adjustment- 119

bleeding- 131

disc calipers - 125,218

faultfinding- 137

front disc brakes - 123,125

front drum brakes - 119

general description - 119

handbrake- 135

hydraulic lines- 131

master cylinder- 127

pedals- 135

pressure regulator- 131

rear brakes - 123

servo mechanism - 135

single master cylinder - 127

specifications - 118

tandem master cylinder- 127

wheel cylinders - 125

**Bulbs**- 138

**Bumpers** 184

**Cam followers** 24, 30

### **Camshaft**

inspection - 24

removal - 24

replacement - 30

### **Carburettors**

Solex 30 PICT/2 and 3 - 58, 60,61

Solex 34 PICT/3-64,197

## **Clutch**

cable operating - 83

fault finding-89

release operating mechanism - 87

removal, inspection and reassembly - 83

specification - 83

**Coil** 83

**Computer diagnosis** 10,155

**Condenser** 78

### **Connecting rods**

inspection - 22

refitting - 28

removal - 22

**Constant velocity joints** -111

**Contact breaker** - 78

### **Cooling system**

fan belt adjustment 42, 46

fan housing - 46

general description 42

heat exchanger - 48

heater controls - 48

supplementary heater- 197

thermostat - 48

**Crankshaft** 26, 28, 30

**Crankshaft pulley wheel** 18

**Cylinder heads** 20,32

**Cylinders** 22,32

## **Dampers**

steering - 177

suspension - 171

**Decarbonisation** 20

**Diagonal trailing arms** 171

**Direction indicators** 149,155

### **Disc brakes**

calipers- 125,208

pads- 123

### **Distributor**

dismantling and overhaul - 77

points - 77

timing- 79

**Distributor driveshaft** - 26, 80

## **Doors**

hinged - 185

rattles- 185

removal - 185

sliding- 191

**Driveshafts** 111

### **Drum brakes**

front- 119

rear- 123

## **Dynamo**

overhaul - 141

testing- 145

## **Electrical system**

battery charging - 141

battery maintenance - 139

direction indicators- 149,155

dynamo- 141,145

fuses- 149

general description - 139



## Index

headlamp washers- 214  
heated rear window-212  
horn- 151  
instrument panel - 209  
lamps- 151  
regulator - 145  
speedometer drive cable - 213  
starter motor - 145  
steering column switches - 214  
stoplight- 151  
warning buzzer- 212  
windscreen washer - 151  
windscreen wiper- 149,151  
wiring diagrams - 157,159 to 164

**Emission control - 70**

### Engine

ancillaries- 18,38  
camshaft - 24,30  
connecting rods - 22,28  
crankcase - 26,28  
crankshaft - 26  
crankshaft oil seal - 24,36  
crankshaft pulley wheel - 18  
cylinders - 22,32  
cylinder heads - 20,32,36  
decarbonising - 20  
dismantling- 18  
faultfinding- 41  
flywheel - 24,31  
general description - 14  
gudgeon pins - 22,32  
installation - 38  
main bearings - 26,28  
oil cooler- 18,38  
oil pressure relief valve - 18  
oil pump- 20,38  
pistons - 22,32  
pushrod tubes - 199  
reassembly final - 38  
reassembly general - 28,38  
removal- 16  
specifications- 12  
static timing - 80  
tightening torques - 14  
valve rockers - 20, 38  
valves - 20,38

**Engine and chassis numbers - 6**

**Exhaust system - 52**

**Fan 46**

**Fanbelt - 42**

**Fan housing - 46**

### Fault finding

brakes - 137  
clutch - 89  
cooling system - 54  
engine - 41  
fuel system - 72  
suspension and steering - 181  
transmission - 109

**Flasher units - 149,155**

**Flywheel 24,31**

**Front suspension 169**

**Fuel gauge 68**

**Fuel pump - 66**

### Fuel system

air cleaner- 58,197  
carburettors- 58,197  
faultfinding - 72  
fuel pump - 66  
fuel tank - 68  
general description - 57  
induction manifold - 70  
specifications - 57

**Fuel tank 68**

**Gudgeon pins - 22,32**

## H

**Handbrake 119,135**

**Handbrake cable - 135**

**Headlamps- 151**

**Heat exchangers - 48**

**Heater, auxiliary - 52**

**Heater controls - 48**

**Horn 151**

**Hub bearings front 169**

### Hydraulic brakes

bleeding- 131  
master cylinders- 127  
pipes- 131  
servo mechanism - 135  
warning lights- 151  
wheel cylinders - 125

### Ignition system

coil - 81

condenser- 77

distributor - 77

faultfinding - 81

firing order - 74

sparkplugs- 81

specifications - 74

static ignition timing - 80

switch, column - 155

**Input shaft - 99**

**Instrument panel 155**

**Intake manifold - 70**

### Lighting system

headlights- 151

instrument lights - 155

rear lights- 151

side markers- 151

warning lights- 151

**Locks 186,188**

### Lubrication

chart - 7

diagrammatic- 23

oil grades - 7

## M

**Main bearings - 26,28**

**Master cylinder**

single- 127

tandem- 127

**Oil cooler - 18,38**

**Oil pressure relief valve - 18**

**Oil pump 20,38**

**Oil seal crankshaft - 24, 36**

**Oil seal gearbox input shaft 107**

**Parking lights - 151**

**Parts replacement 6**

**Parts replacement 6**

## Index

### Pistons

- assembly to conrod - 32
- assembly to cylinder - 32
- fitting of rings - 22,32
- inspection - 22
- removal - 22

### Points, contact breaker - 78

### Pump fuel 66

### Pump oil - 20, 38

### Pushrods 36

### Pushrod tubes 36,197

### Rear brakes 123

### Rear lamps - 151

### Recommended lubricants and fluids - 7

### Regulator (voltage) 145

### Relays and fuses 149

### Rocker adjustment - 38

### Rocker assembly 36

### Routine maintenance 9,196

### Safety first! 221

### Seats- 191

### Silencer - 52

### Sliding door- 217

### Sliding roof - 188,218

### Spark plugs - 81

### Specific gravity, electrolyte 141

### Stabilizer bar 171

### Starter motor 145

### Steering

- adjustments - 173
- dampers 177
- description- 167
- dismantling and overhaul - 173,177
- faultfinding- 181
- geometry 179
- balljoints- 177
- rear torsion bars 217
- removal and replacement - 173
- roller shaft oil seal 217
- track rod and joints - 177
- wheel and column - 177

### Steering, cam and peg 175

### Steering, cam and roller 176

### Striker plate, adjustment - 188

### Supplement

- bodywork - 182
- braking system - 208
- cooling, heating, exhaust - 197
- electrical system - 209
- engine- 197
- fuel system- 197
- introduction- 196
- routine maintenance - 196
- specifications- 197
- steering and suspension - 217
- transmission - 198

### Suspension

- dampers - 171
- faultfinding- 181
- front- 169
- rear- 171

### rear torsion bars- 217

### specifications - 165

### torsion bars- 171

### torsion bars and spring settings - 171

### Tandem master cylinder - 127

### Thermostat - 48

### Throttle positioner 70

### Timing marks 80

### Tools and working facilities 5

### Torsion bars 171

### Torque wrench settings

- brakes- 119
- engine - 14
- fan- 139
- generator - 139
- rear axle- 111
- steering and suspension - 167
- transmission - 91

### Transmission

- case - 206
- differential 107
- differential limited slip - 107
- faultfinding- 109
- final drive - 207
- gear carrier - 99,101,200,206
- gearchange rod - 198
- gearshift- 101,107
- input shaft assembly - 99
- input shaft oil seal - 107
- inspection for wear - 97
- main casing bearing assembly - 99,101
- mainshaft - 200,203
- manual type 091 - 198
- pinion shaft, assembly - 99, 200, 203
- reassembly, gearbox - 99
- removal gearbox - 95
- selector forks- 206
- specifications - 91
- synchro hub- 198
- synchro mesh assembly - 107

### Trim, door 186

### Turn signal indicators switch - 155

### Tyres 179

### Valve tappet clearances 38

### Vehicle identification and spare parts - 8

### Voltage regulator 145

### VW diagnosis • 9,155

## W

### Wheel and tyres 179

### Wheel bearings (front) 169

### Wheel bearings (rear) 115

### Wheel cylinders 125

### Window glass 183,186

### Windscreen 184

### Windscreen washers 151

### Windscreen wipers - 149,151

### Wiring diagrams - 157,159 to 164