

Volkswagen Owner's Manual: Operation and Maintenance

Type 2

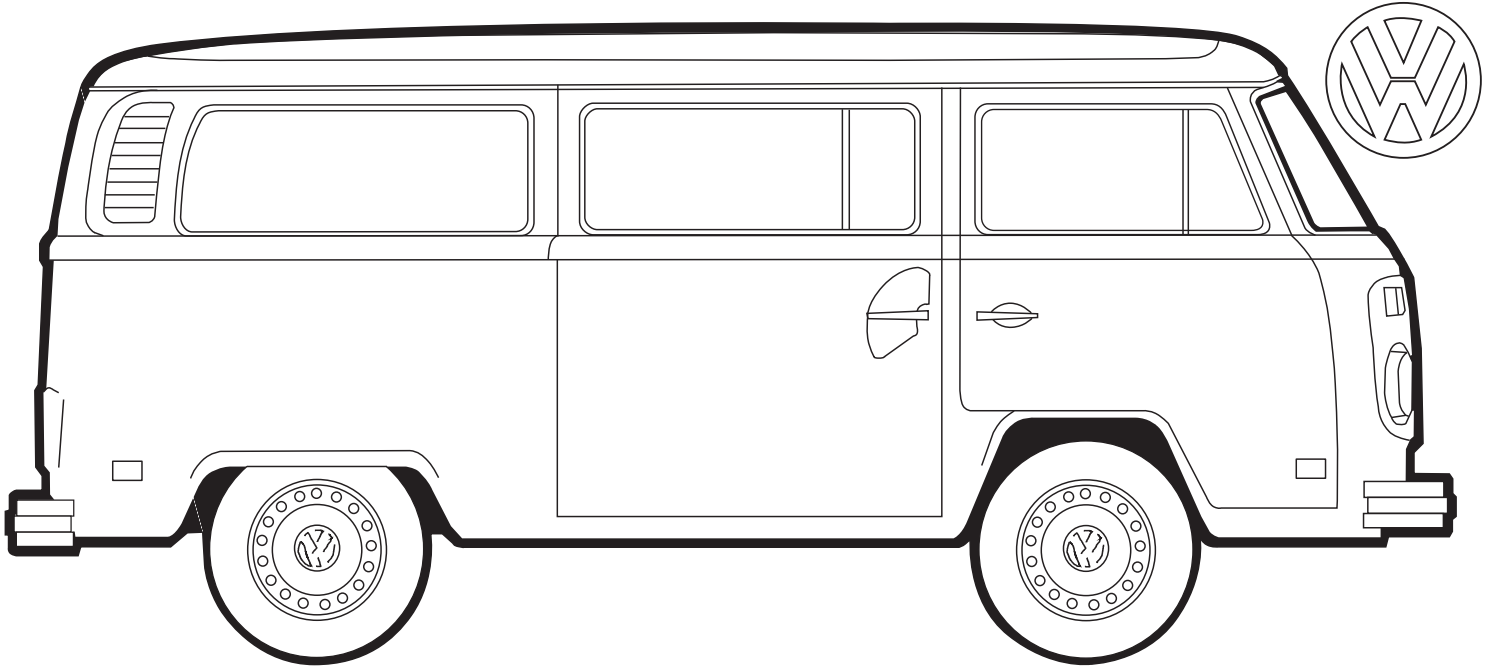

Owner:

Last name

First name

Initial

Street

Town

State

Zip code

Area code

Tel. No.

Volkswagen Owner's Manual: Operation and Maintenance

1973 Models



Volkswagen
Station Wagon
and Kombi



Volkswagen
Campmobile



Volkswagen
Delivery Van

V O L K S W A G E N W E R K A K T I E N G E S E L L S C H A F T

Revisions:

A - 21-12-2010

Corrected various misspellings and adjusted content layout to be more consistent

Corrected Bulb list on Page 54

©1972 Volkswagenwerk Aktiengesellschaft

May not be reproduced or translated in whole or in part without the written consent of Volkswagenwerk.
Specifications subject to alteration without notice. All rights reserved.

2.02.563.007.23

Printed in Germany 8. 72
Retyped/Printed in USA 12. 10

The VOLKSWAGEN OWNER'S MANUAL consists of two major parts: operation description and Diagnosis & Maintenance record.

The first acquaints you with your Volkswagen Warranty and the operation of your car. It also gives you information on fuel, oil, lubrication, plus technical data.

The second part deals with the maintenance of your Volkswagen. It explains what the VOLKSWAGEN DIAGNOSIS and MAINTENANCE is all about, and how to keep your Volkswagen in top driving condition. Check the mileage chart at the end of this manual. It will tell you when to bring your car to your Authorized Volkswagen Dealer for periodic oil changes, diagnosis and maintenance services.



The first maintenance service at 600 miles is free of charge (you only pay for engine and transmission oil).

You are further entitled to free diagnosis services at 6,000, 12,000, 18,000 and 24,000 miles.

Always have your Volkswagen's Owner's Manual with you when you take your car to an Authorized Volkswagen Dealer for services . . . it provides your Service Adviser with the information he needs and enables him to make the necessary entries for you.

Please read this manual before you drive your new Volkswagen. Acquaint yourself with its features, and know how to operate it more safely . . . because the more you know about it, the more you will enjoy driving your Volkswagen.

Pictures and text in this manual are based on the 1973 Volkswagen Station Wagon with manual transmission. Where the controls, equipment and technical data of the commercial models and the Automatic Transmission differ considerably, we will point this out in the text.

Various items shown or described in the manual may be options on certain models. Check with your authorized VW dealer on available options or accessories.

It has always been Volkswagen's policy to continuously make technical improvements; therefore, the right is reserved to make changes at any time during the model year without notice.

Contents

| | | | | | |
|---|-------|---|-------|--|----|
| Address change cards | 85 | Fuel gauge | 23 | Safety belts | 21 |
| Air cleaner | 61 | Fuel supply | 51 | Seats | 19 |
| Air conditioner | 37 | Fuses | 49 | Sliding door | 17 |
| Alternator warning light | 24 | Headlight switch | 25 | Sliding roof | 34 |
| Ashtrays | 34 | Heater | 34 | Spare wheel | 44 |
| Assist handles and coat hooks | 27 | Ignition/steering lock | 23 | Spark plugs: cleaning and replacing | 57 |
| Automatic Transmission | 30 | Instrument illumination | 25 | Speedometer | 24 |
| Automatic Transmission Fluid | 60/64 | Instrument panel | 22 | Starting hints | 33 |
| Auxiliary heater | 39 | Interior light: front | 27 | Sun visors | 27 |
| Battery | 50 | rear | 25 | Technical data | 69 |
| Brake fluid reservoir | 48 | Jack | 44 | Tires | 42 |
| Brake warning light | 24 | Key | 16 | Towing and trailer hauling | 40 |
| Bulb chart | 54 | Lane changer | 26 | Transmission oil grades | 64 |
| Bulb replacing | 54 | Lubrication | 62 | Troubleshooting | 65 |
| Changing a wheel | 45 | Maintenance record | 79 | Turn signal/headlight dimmer switch lever | 26 |
| Chassis number | 15 | Manual transmission | 28 | Vehicle Identification | 15 |
| Checking and changing engine oil | 58/59 | Manual transmission oil | 60/64 | Ventilation | 36 |
| Cleaning your VW | 52 | Oil pressure warning light | 24 | Warning lights | 23 |
| Dear VW Owner | 13 | Rear view mirrors | 27 | Warranty | 7 |
| Defogging and defrosting | 35 | Rear window defogger | 25 | Windows | 18 |
| Diagnosis and Maintenance | 76 | | | Windshield washer fluid container | 48 |
| Distributor addresses | 68 | | | Windshield wiper/washer lever | 26 |
| Doors | 16 | | | Winter operation | 41 |
| Emergency flasher | 25 | | | | |
| Engine compartment | 57 | | | | |
| Engine oil grades | 63 | | | | |

Volkswagen offers a quality product. Maintain this quality by having your Volkswagen serviced regularly. A service schedule that we recommend is explained in the section Volkswagen Diagnosis and Maintenance.

Should you have occasion to make use of your Volkswagen Warranty, it is always helpful to have the related service receipts handy.

WARRANTY VOUCHER

for the new VW automobile

Type: _____

Chassis No. _____

Engine No. _____

In accordance with the **terms of warranty** printed overleaf.

The warranty commences at the date the VW automobile is delivered to the original purchaser,

viz. on _____

(To be filled in by selling VW Dealer)

and covers a period of 24 months or the period before the vehicle has been driven 24,000 miles, whichever event shall first occur. Should any warranty claim arise, you are requested to present this voucher to your VW Dealer.

VOLKSWAGEN OF AMERICA, INC.

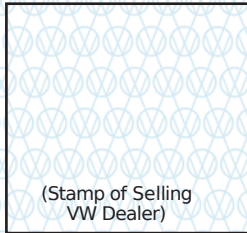

Air Conditioner Installation



Date _____

At Mileage _____

Make, Model _____

Auxiliary Heater Installation

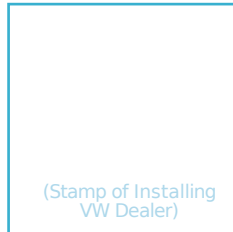

Date _____

At Mileage _____

Make, Model _____

Speedometer Replacement



Date _____

At Mileage _____

Make, Model _____

No other express warranties, as to Volkswagen vehicles sold in the United States are made either by Volkswagen of America, Inc. ("VWoA"), or by the manufacturer, the distributor or the selling dealer, except the following warranty by Volkswagen of America, Inc.

Warranty for New Volkswagen Vehicles

This warranty is issued by Volkswagen of America, Inc. ("VWoA"), the authorized United States importer of Volkswagen vehicles.

Free repair or replacement in the United States and Canada of defective parts for 24 months or 24,000 miles.

1. VWoA warrants that every Volkswagen vehicle imported by VWoA and sold as a new vehicle to a retail customer by an authorized United States Volkswagen dealer will be free from defects in materials and workmanship under normal use and service for 24 months after the date of delivery of the vehicle to the original retail customer or until the vehicle has been driven 24,000 miles, whichever comes first. This warranty is limited, however, to the following: If any part of the vehicle becomes defective under normal use and service and the vehicle is brought during this period to the workshop of any authorized Volkswagen dealer in the continental United States, Hawaii or Canada, the dealer will, without charge, either repair the defective part or replace it with a new or factory reconditioned part.

Maintenance required to keep warranty in effect.

2. In order to keep this warranty in effect, the owner must have the vehicle maintained and serviced as prescribed in the Volkswagen Maintenance Schedule.

Items not covered by warranty

3. VWoA's warranty does not cover:

- (i) Defects, damage or deterioration due to normal use, wear and tear or exposure;
- (ii) normal maintenance services, such as fuel system cleaning and wheel, brake or clutch adjustments;
- (iii) the replacement of service items, as for instance, spark plugs, ignition points, wiper blades or brake linings;
- (iv) deterioration of upholstery, soft trim and appearance items;
- (v) damage or defects due to misuse, alteration, negligence or accident;
- (vi) damage or defects due to the repair of the vehicle by someone other than an authorized Volkswagen dealer or the installation of parts other than genuine Volkswagen parts;
- (vii) damage or defects due to the use of the vehicle in competitive events, including rallies and races; and
- (viii) loss of time, inconvenience, loss of use of the vehicle or other consequential damage.

Warranty outside the United States and Canada

4. If the vehicle is brought to an authorized Volkswagen workshop outside the continental United States, Hawaii or Canada, VWoA's warranty will not be applicable and defective parts will be repaired or replaced free of charge with new or factory reconditioned parts only within the terms and limitations of the warranty for new Volkswagen vehicles in effect in the country where such authorized Volkswagen workshop is located.

No other warranties made

5. This warranty is in lieu of all other express warranties of VWoA, the manufacturer, the distributor and the selling dealer. Neither VWoA nor the manufacturer assumes, or authorizes any person to assume, on its behalf, any other obligation or liability.

Let us explain the warranty . . .

Volkswagen of America Inc. is proud of the quality of the automobiles it imports. It warrants new vehicles for a period of 2 years or 24,000 miles from the date of purchase, whichever comes first. In general, the complete vehicle including battery and tires is covered under the provisions of the Volkswagen New Vehicle Warranty. It will be honored by any Authorized Volkswagen dealer in the continental United States, Hawaii and Canada.

This warranty is transferable if the ownership of the vehicle changes within the above period.

In order to keep the warranty in force, you, as the owner of the vehicle, have certain responsibilities. It is important that the vehicle be maintained properly. To facilitate record keeping, this booklet provides space for listing diagnosis, maintenance, and oil change services as they are performed.

Diagnosis and maintenance services should be performed by Authorized Volkswagen dealers. They have Volkswagen trained mechanics and special tools to provide fast, efficient service in accordance with Volkswagen quality standards.

The terms of your warranty require you to keep a maintenance record of your vehicle. Provided that maintenance or oil change services were performed in accordance with Volkswagen specifications, dated bills of other than Authorized Volkswagen dealers will be accepted as proof that these services were performed when required.

Not all repairs, adjustments and replacements, however, are the result of defects in material or workmanship. There are other circumstances beyond the control of the manufacturer that might make a workshop visit necessary. These depend mainly on where you drive and how you drive. They would include weather and atmospheric conditions, varying road surfaces, individual driving habits and vehicle usage.

For example, you are required to pay for the following:

Lubrication services.

Diagnosis and Maintenance services — except those free of charge as specified in the Owner's Manual.

Wheel alignment and wheel balancing. The frequency of these services depends on driving conditions such as rapid starts and stops, tire skidding, hitting pot holes and curbs, etc.

Mechanical adjustments — including brakes, clutch, door locks — are required as a matter of normal operation of a motor vehicle. This protects you against early or expensive replacements.

Brakes and clutch linings are directly affected by driving habits and use. The replacement of brake linings, brake pads, clutch linings and shock absorbers, and the reconditioning of brake drums and brake discs should be performed whenever necessary.

Spark plugs and ignition points are subject to wear. Periodic replacements ensure you of maximum engine performance and gasoline economy.

Wiper blades will have a varied life expectancy, depending on climatic conditions and extent of use. You are the best judge of when they should be replaced.

Light bulbs and fuses are service items.

Paint, chrome, trim and other appearance items are affected by normal wear and exposure. Proper care of these items can add to their appearance and durability. (Imperfections are normally apparent during New Vehicle Delivery Inspection. For your protection, please report any imperfection to your dealer immediately.)

Tires and battery are subject to wear. If there is a manufacturer's defect, you pay only for the amount of use you obtained. An adjustment for tires is based on the remaining tread depth. Battery adjustment is according to time used, based on 24 months of service. This is known as the pro-rata method of adjustment.



Volkswagen parts, accessories and exchange units are identified by these trademarks.

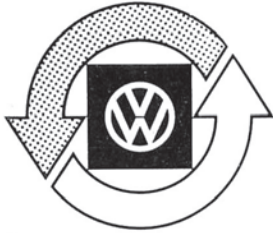

All meet the same exacting quality control standards as the original equipment on the car, and comply with all applicable Government safety regulations.

They are guaranteed to be free from defects in material or workmanship for a period of 6 months or 6,000 miles, whichever comes first.



All Volkswagen parts and accessories are available at your Authorized Volkswagen Dealer.

Also, ask him about rebuilt parts under the Volkswagen Exchange Service . . . they cost less than new parts but carry the same warranty.



Dear VW Owner:

A lot has gone into the manufacture of your Volkswagen. Including advanced engineering techniques, rigid quality control and demanding inspections. The engineering and safety features that have gone into your VW will be enhanced by . . . you,

the safe driver — who knows his vehicle and all the controls,
— who maintains his vehicle properly,
— who uses his driving skills wisely.

Because safe driving is important to you, we urge you to read this manual carefully, to maintain your VW properly and to follow the check list shown on this page whenever you use your VW.

Before getting behind the wheel:

- 1 - Make sure that the tires are inflated correctly.
- 2 - Watch the tread depth indicator on the tires. Look for bruises and wear.
- 3 - See that all windows are clean and unobstructed.
- 4 - Check that headlight and tail light lenses are clean.
- 5 - Check that all lights are functioning properly.
- 6 - Check turn signal lamps and indicator light (ignition on).

In the driver's seat:

- 1 - Position seat properly for easy reach of controls.
- 2 - Adjust inside and outside mirrors for unobstructed rear view.
- 3 - Fasten safety belts.
- 4 - Check brake warning light when starting the engine.
- 5 - Check brake operation.
- 6 - Make sure that all doors are closed securely and locked.

And when you are on the highway:

- 1 - Always drive defensively. Expect the unexpected.
- 2 - Use signals to indicate turns and lane changes.
- 3 - Turn on headlights at dusk.
- 4 - Follow at a safe distance. A good rule of thumb is to allow a minimum of one car length for each 10 mph of speed.
- 5 - Reduce speed during night hours and inclement weather.
- 6 - Observe speed limits and obey highway signs.
- 7 - When tired, get off the highway, stop and take a rest.
- 8 - When stopped or parked, always set the parking brake.
- 9 - When stalled or stopped for repairs, move the car well off the road. Set the emergency flasher and use road flares or other warning devices to warn other motorists.

This additional line
applies only to the
Campmobile

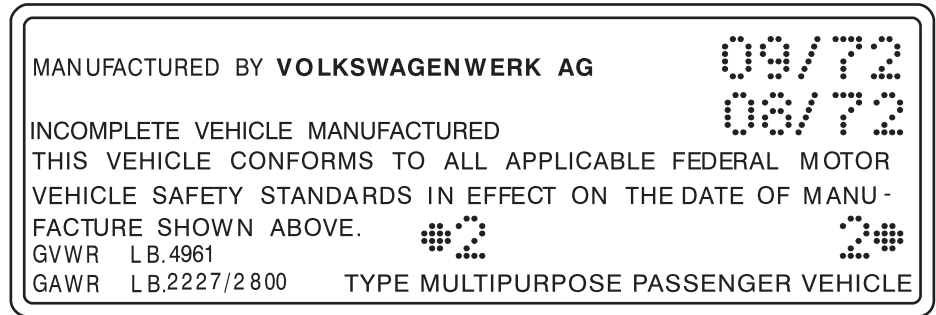

This sticker is your assurance that your 1973 Volkswagen complies with all U.S. Federal Motor Vehicle Safety Standards which were in effect at the time the vehicle was manufactured. You can find this sticker on the left doorjamb.

This sticker also shows the month and year of production and the chassis number of your car (perforation) as well as the **Gross Vehicle Weight Rating** and the **Gross Axle Weight Rating**.

This sample shows the weight ratings of the Campmobile and the Station Wagon.

Vehicle Identification:



The Identification Plate

is the “birth certificate” of your Volkswagen. It is located behind the front passenger seat.

The plate shows such information as manufacturer’s name, place of origin, model, weights, and “Fahrgest.-Nr.”, which is the chassis number of your car. The sticker behind the driver’s seat shows the color code.



The Chassis Number

is also located on the instrument panel on the driver’s side so that it is visible from the outside through the windshield. This is for your protection . . . to aid in the apprehension of car thieves and the recovery of stolen vehicles.

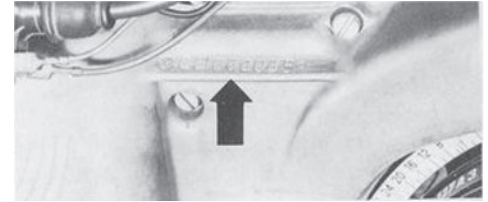

The Engine Number

is stamped on the crankcase below the breather (not visible). And also near the ignition coil.

The chassis number is also stamped on the left-hand engine cover plate.

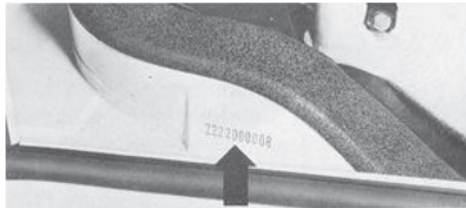

Key

The same key is used for the ignition/steering lock, the doors and the rear luggage compartment.



It is a good idea to keep a record of your key number in your wallet together with your license. If you should lose a key, your Authorized VW Dealer will thus be able to quickly secure a replacement key for you.

DO NOT INVITE CAR THEFT

by leaving your car unattended with the key in the ignition lock. Take the key with you and lock the doors.

A buzzer will remind you when you open the driver's door and the key is still in the ignition lock.

Doors

Always drive with locked doors to prevent inadvertent opening of the door from the inside, especially with small children in the car.

Since your Volkswagen is almost air tight, it will be easier to close the door if you open a window slightly.

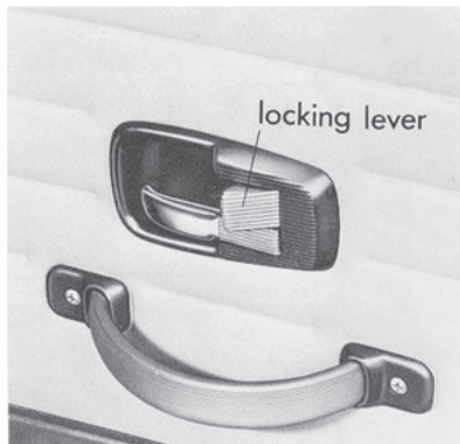

To lock and unlock front doors from the outside

You can lock and unlock your car with a key, of course.

But you can also lock it without a key.

First depress the locking lever in the inside door handle. Then depress the plunger in the outside door handle as you close the door.

If the door, with the locking lever depressed, closes by itself, the locking device will disengage automatically. We provided this additional safety feature so you won't be locked out if the door should slam shut while the key is still inside the car.

To lock and unlock front doors from the inside —

depress or pull out the locking lever in the inside door handle.

The sliding door

Always drive with a securely locked sliding door.

To open the sliding door from the outside, press the handle down and slide the door to the rear. The door is held in the fully open position by a catch.

To close the door from the outside, press the handle down first to release the catch. Slide the door forward until it latches. Then pull the handle up firmly until the sliding door is flush with the rear panel.

You can lock the sliding door from the outside with the key. A sliding door that has been locked from the outside can only be opened with the key from the outside.

To open the sliding door from the inside, move the door handle forward, to position — A —, and slide the door open.

To close the door from the inside, move the handle forward first to release the catch. Slide the door forward until it latches. Then pull the handle up, to position — B — to make sure the door is securely closed.

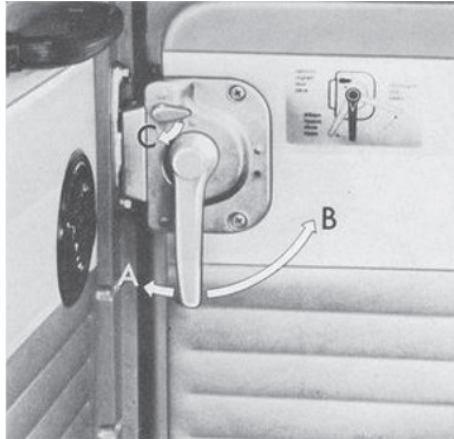

To lock the sliding door from the inside, depress the small lever to position — C —. A sliding door that has been locked from the inside can only be unlocked from the inside. On the Delivery Van, the cargo compartment can be locked from inside with a small sliding knob instead of the locking lever — C —. To lock, move the sliding knob to the right.

On the VW Delivery Van, with a full partition between the driver's cab and the cargo compartment, open the sliding door from the inside by pulling the inside handle to position — D —.

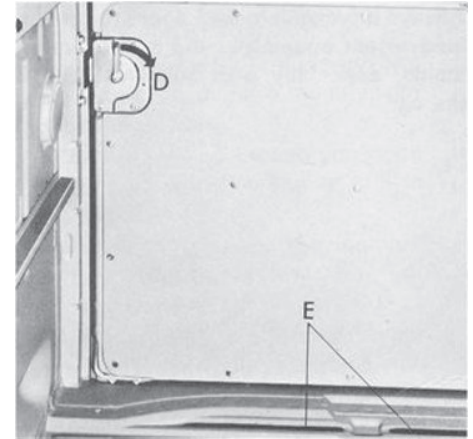

In the VW Kombi and VW Delivery Van, embossed lines — E — on the cargo compartment floor mark the limit up to which cargo can be loaded without obstructing the operation of the sliding door.

The rear lid

The rear luggage compartment is easily accessible through the lid at the rear of the vehicle. You lock and unlock it with the key.

To open the lid, depress the lock and raise the lid until it is held in the fully open position by springs. Do not let the lid fly open on its own.

To close the lid, swing it down firmly. Always make sure it is properly closed and locked.

Do not drive with the rear luggage compartment lid open. This precludes the possibility of exhaust fumes entering the car.

Windows

We have made the windshield and windows large for clear, unobstructed visibility.

We recommend you do not put decals or other signs on the windows of your car that will interfere with the driver's vision.

You can lower and raise the windows in the front doors by using the window winders. We cushioned the knobs for your safety.

Vent windows
(VW Station Wagon only)

To open the vent windows, turn knob in driving direction, move locking lever forward and push out window.

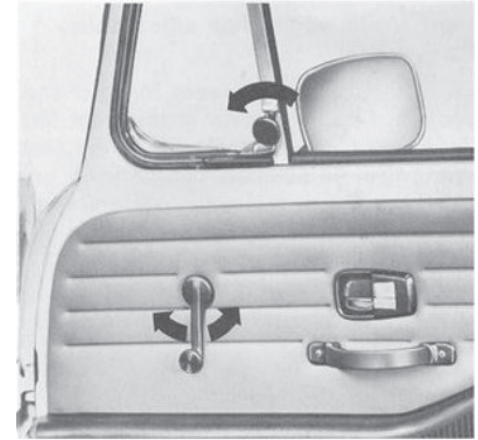

To make closing the vent window easier, we suggest you first push on the forward part of the vent window so that it fits snugly against the weatherstripping. Then grasp the knob, and move the lever back to lock it in place.

Seats

We recommend you do not adjust the driver's seat while driving. Your seat may suddenly jerk forward or backward, which could result in loss of control.

Your Volkswagen has adjustable front seats

To move the driver's seat forward and backward, pull the lever at the front left hand side of the seat. Now slide the seat to the desired position. Let the lever go, and move the seat slightly back and forth to make sure it is securely engaged.

Head restraint (optional)

A head restraint can be installed for each seat. The head restraints cannot be adjusted.

To remove, pull head restraint out. To install, push head restraint in as far as possible.

Removing and installing driver's seat

With the adjustment lever raised, slide the seat all the way forward until the runner touches the leaf spring stop. Stand outside the car, pull the leaf spring stop with the right hand and, with the adjusting

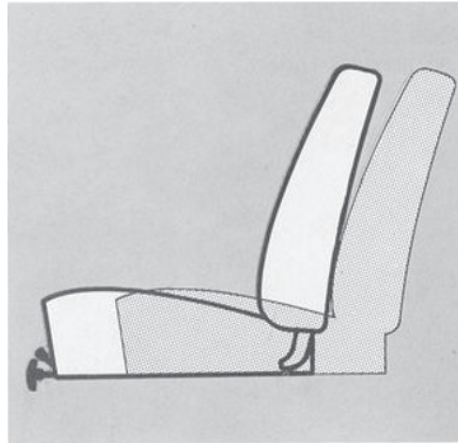

lever raised, slide the seat fully off the tracks. Lift out.

To reinstall the driver's seat, stand outside the vehicle and position the seat in front of the tracks. Hook the inboard seat track first. Then insert the outer runner by pulling the seat slightly toward you. With the adjustment lever raised, slide the seat back on the tracks.

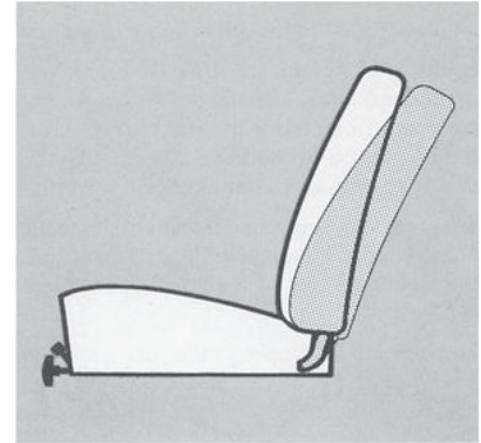

The backrest is secured and cannot tilt forward accidentally. It can be adjusted to different angles by turning the hand wheel at the front of the seat.

The front passenger seat can be adjusted to two different positions. Lift the seat cushion at the front edge and move the seat into the second notch.

Keep the backrest hooked into the bracket on the partition when adjusting the seat position.

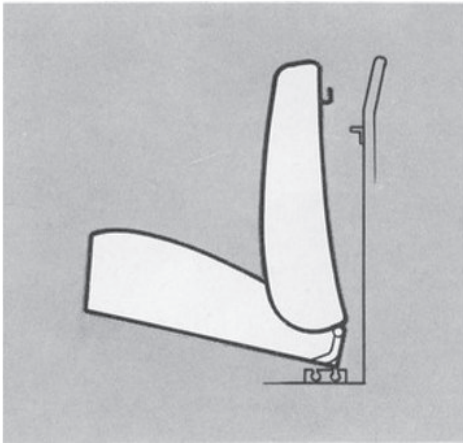

Removing and installing the front passenger seat

Lift it at the front edge first; then remove.

When putting the seat back in again, hold the seat with the seat cushion tilted toward the backrest, slide the hook on the rear side of the backrest into the bracket on the partition. Insert the seat cushion in the desired notch, and fold the seat cushion down. Always check to be sure the backrest is securely attached to the partition.

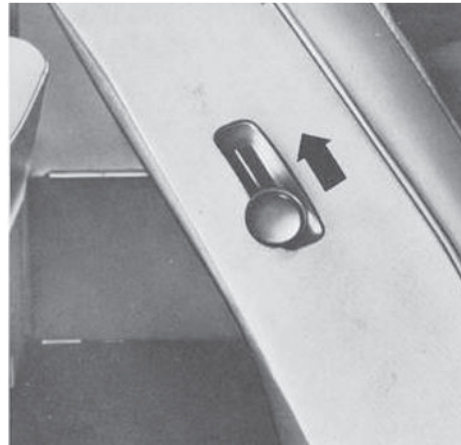

Passenger compartment

In the 9-seater version, the backrest of the first seat in the middle row can be tilted forward and out of the way for easy access to the rear bench. To disengage the lock of the backrest, pull up the lever on the side of the backrest.

Removing and installing seats in the rear passenger compartment

All seats in the rear passenger compartment can be taken out. First remove the sides and front trimming from the seat frames.

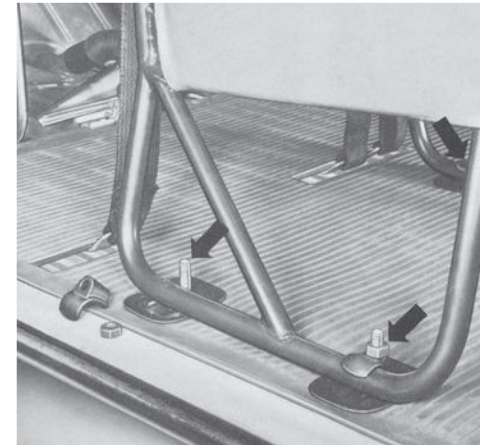

Then unscrew the nuts and take off the mounting supports. Remove seats. Take out bolts by turning them.

When reinstalling the seats use all bolts, mounting supports, and nuts. Be sure to tighten the nuts firmly.

Safety belts

A safety belt is provided for each seating position in your Volkswagen. For your protection, fasten your safety belt before driving off and wear it at all times while the car is in motion.

Store safety belts of unoccupied seats properly. This reduces the possibility of their becoming a striking object in case of a sudden stop.

Belt care

Keep safety belts clean. If cleaning is necessary, wash them with a mild soap solution, without removing them from the car. Do not bleach or dye safety belts. Do not use any other cleaning agents. They may weaken the webbing.

Check buckles and retractors for proper function. Check belt webbing and bindings for damage.

Safety belts for front seats

The **front seats** are equipped with **combination lap/shoulder belts**. For easy storage a hook is provided on the door post.

A shoulder belt should not be worn by a person less than 4'7" in height because it would not be in its most protective position, and therefore may increase the possibility of injury in a collision.

To **fasten** your **combination lap/shoulder belt**, grasp the belt tongue, take it off the hook on the door post and pull the belt across your lap and chest.

Insert the belt into the anchor housing on the inboard side of the seat and push down until it is **securely locked**.



To **unfasten the belt**, push in the release marked **PRESS** in the anchor housing. The belt tongue will spring out of the anchor housing.

When not in use the belt should be hung on the hook provided for this purpose on the door post.

Belts should not be worn too loose or twisted. They should fit snugly across your body. The lap belt section should be completely unrolled from the retractor.

Do not strap in more than one person in each belt.

To **adjust** the length of the belts, press in the release in the buckle as you pull the respective belt section in the desired direction. With this release it is also possible to adjust the belt length with the

buckle already engaged in the anchor housing. Take up any slack of the loose belt by moving the slide on the belt.



Safety belts for rear seats

The rear seats are equipped with adjustable lap belts.

Pull the longer section across your lap and insert the tongue in the inboard buckle. Push in until you hear a click to be sure the belt is locked securely.

The belt should not be worn loose or twisted.

To **unfasten** the belt, push in the release marked **PRESS** in the buckle.

To **lengthen** or **shorten** the rear belt, hold the belt tongue at a right angle to the belt and pull the respective belt section in the desired direction. Take up any slack of the loose belt end by moving the slide on the belt.

Instrument panel

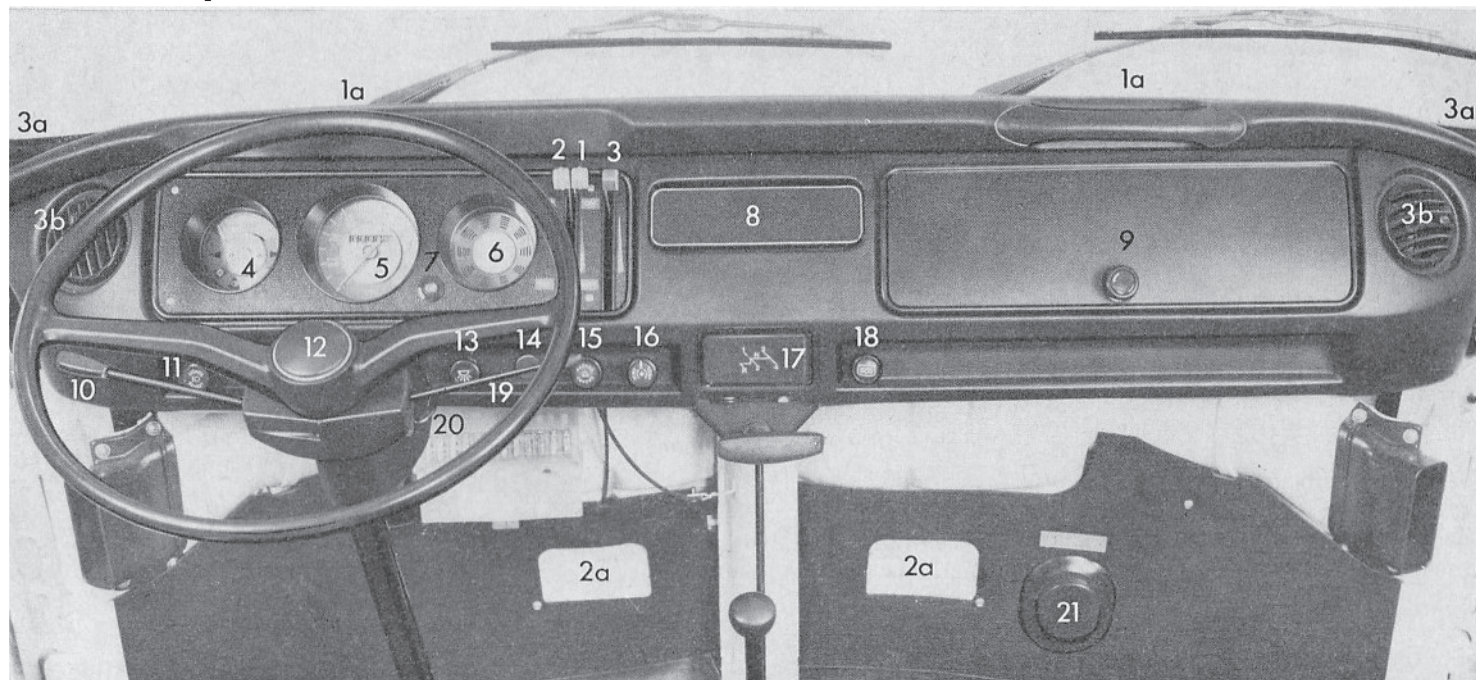

- | | | |
|--|--|---|
| 1 - Heater temperature lever (TEMP) | 3b- Vents for fresh air ventilation on the dashboard (one for each side) | 13 - Interior light switch for rear |
| 1a- Vents for heating and defrosting (two for each side) | 4 - Fuel gauge and warning lights | 14 - Windshield wipers/washer lever |
| 2 - Heat distribution lever (HEAT-DEF) | 5 - Speedometer | 15 - Emergency flasher |
| 2a- Warm air outlets for front leg area (one for each side) | 6 - For installation of optional equipment: electric clock | 16 - Control knob for Auxiliary Heater (optional equipment) |
| 3 - Fresh air control lever | 8 - Plate over radio aperture | 17 - Ashtray |
| 3a- Vents for fresh air ventilation below the windshield (one for each side) | 9 - Glove compartment | 18 - Rear window defogger |
| | 10 - Turn signal/headlight dim switch lever | 19 - Location for optional accessory switches |
| | 11 - Headlight switch | 20 - Ignition/steering lock |
| | 12 - Horn button | 21 - Container for windshield washer fluid |

Ignition steering lock

The steering is equipped with an anti-theft ignition lock.

Fasten safety belts.

Make sure the gearshift lever is in Neutral (Manual Transmission) when starting the engine. The Automatic Transmission can be started in Neutral or Park (also see pages 30 and 33).

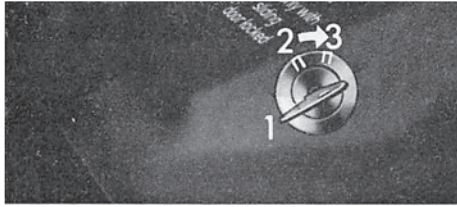

1 - Ignition off/steering locked.

Insert the key. If it is difficult to turn the key, gently move the steering wheel until the key turns freely.

2 - Ignition on/steering free (for towing).

3 - Starter engages.

The key returns to position 2 as soon as it is released. Never operate the starter for longer than a few seconds. If the engine should fail to start, turn the key back to position 1, and repeat the starting procedure. More on starting on page 33.

To remove the key and to lock the steering, turn the key back to position 1 and pull it out. Turn the steering wheel until it locks.

The steering column will lock when you remove the key. Therefore DO NOT REMOVE the key while you are driving or as the car is rolling to a stop.

If you leave the key in the ignition/steering lock, the buzzer will sound when the driver's door is opened. This is your reminder to remove the key.

Fuel gauge

The fuel gauge only works with the ignition on.

When the needle is on the "R", there is a reserve of about 1 gallon of fuel left in the tank . . . time to refuel at the next gas station.

Indicator or warning lights

The following indicator or warning lights are in the fuel gauge dial.

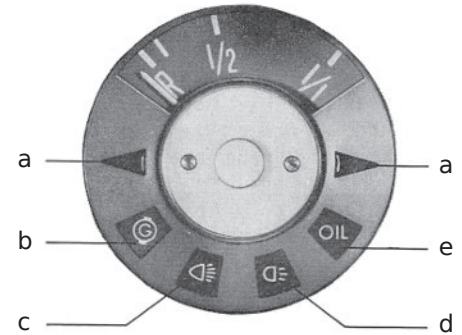

a - green  turn signals

b - red  alternator

c - blue  high beam

d - green  parking light

e - red  oil pressure

The red warning lights for **alternator** and **oil pressure** will light up in the fuel gauge dial when the ignition is turned on. They should go out after you have started the engine.

b - Alternator warning light

If this light comes on when you are driving, the alternator has stopped charging. You can drive on. But try to get the vehicle to an Authorized Volkswagen Dealer as soon as possible because the battery will soon run down.

Whenever stalled or stopped for repair, move the car well off the road. Turn on the emergency flasher and mark the car with road flares or other warning devices. Before working on any part in the engine compartment, wait until the engine has sufficiently cooled down.

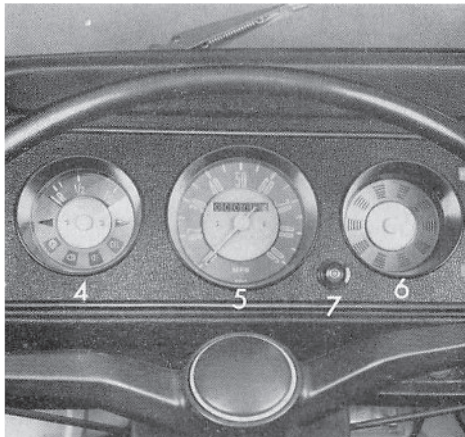

e - Oil pressure warning light

STOP AT ONCE . . .
If the oil pressure warning light comes on when are driving.

Check the oil level to make sure you have enough oil. If the oil level is normal, do not drive on but contact your nearest Authorized VW Dealer.

An occasional flickering of the oil pressure warning light when the engine is idling after a long high-speed trip is no cause for concern if the light goes out upon acceleration.

5 - Speedometer dial

The speedometer indicates the speed; the odometer records the miles driven. The last digit in red indicates 1/10 of a mile.

6 - this dial can be used for installation of **an electric clock**, which is optional equipment. To set the clock, depress the knob in the center and turn.

7 - Brake warning light

Your Volkswagen is equipped with a dual circuit brake system. Both circuits, one for the front brakes and one for the rear brakes, can function independently.

If the brake warning light lights up when you apply the brakes while driving, one of the two brake circuits may have failed. The other brake circuit will still operate, but a longer distance and greater pedal pressure are required to bring the car to a halt.

Pull off the road and stop

Try out the effectiveness of the brakes by carefully starting and stopping on the road shoulder.

If you judge that the brakes operate safely enough to take you to the nearest dealer, proceed cautiously and at low speed. If you do not feel it is safe to continue, have your car towed to the nearest dealer for repair.

Proper functioning of brake warning light

The brake warning light will light up when the ignition is turned on. It will go out after the engine has been started. This is your assurance that the brake warning light functions properly. If the brake warning light does not light up when turning on the ignition, or if it does not go out after starting, there may be a defect in the electrical system. If this is the case, contact your Authorized VW Dealer.

11 - Headlight switch



Pull the knob to the first stop to turn on the parking lights, the side marker lights, the license plate, tail and instrument lights. The green indicator light will light up on the lower right hand side of the fuel gauge dial.

Pull the knob to the second stop to turn on the headlights. The headlights only work with the ignition on.

To preserve the battery, the headlights will go out automatically when the ignition is turned off or when the engine is started.

Instrument illumination

Adjust the brightness of the instrument

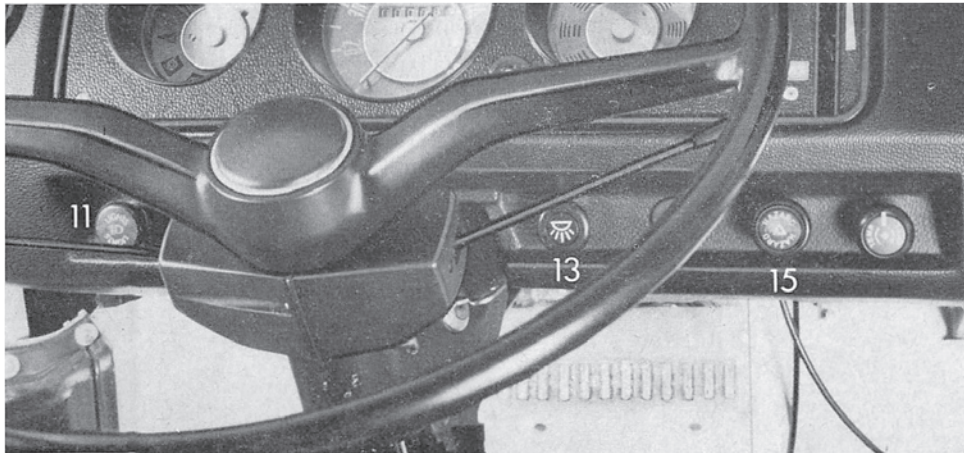

lights by turning the headlight switch knob.

13 - Interior light switch for rear passenger compartment

Pull out the knob to turn on the light in the rear of the passenger compartment.

15 - Emergency flasher switch



If your car is disabled or parked under emergency conditions, pull the switch to make all four turn signals flash simultaneously. The warning light in the switch knob flashes, too. The light in the flasher switch will glow when the parking lights or headlights are turned on.

Move the car well off the road when stalled or stopped for repairs.

18 - Rear window defogger



Turn ignition on first.

Pull out the knob to activate the rear window defogger.

The green control lamp in the knob will light up to remind you that the defogger is switched on.

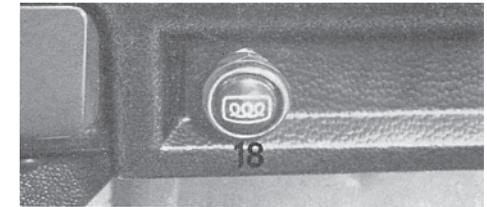

The rear window defogger will help to keep the inside of the rear window clear of condensation and frost in the winter. Be careful when removing objects from the luggage compartment behind the rear seat. Sharp edges may damage the defogger in the rear window.

After the rear window has cleared, switch the rear window defogger off to avoid unnecessary drain on the battery.

To give you full battery power while starting the engine, the operating rear window defogger will turn off automatically at this moment.

Turn signal/headlight dimmer switch lever and windshield wiper/washer lever

There are two levers just behind the steering wheel:

The lever on the left side is for the turn signal/headlight dimmer switch.

The lever on the right side is for the windshield wiper/washer system.

The turn signals and the windshield wipers only work with the ignition on.

Turn signals

Lever up — right turn signal
Lever down — left turn signal

The green turn signal indicator light comes on in the fuel gauge dial when you operate the lever.

The turn signals are canceled automatically when you have completed a turn (like driving around a corner), and the steering wheel returns to the straight-ahead position.

Lane changer

If you are just changing lanes on an expressway, slightly lift or depress the lever. When you release your hold on the lever, it will return to the OFF position.

If a turn signal is defective, the control light flashes at about twice the normal frequency. Have your Authorized VW Dealer check and repair it for you.

Headlight dimmer

Dim the headlights by pulling the lever toward the steering wheel. The blue indicator light will light up in the fuel gauge dial when the high beams are on.

Windshield wipers

The windshield wiping system operates at two speeds: low and high.
Lifting lever to first stop — low speed
Lifting lever to second stop — high speed
If you just slightly lift the lever before

reaching the first stop, the wipers will wipe as long as the lever is held in this position and come to a stop when released.

To give you full battery power while starting the engine, operating windshield wipers will stop automatically at this moment.

Windshield washer WASH

To spray washer fluid on the windshield, pull the lever toward the steering wheel. You can operate the washer from any selected wiping position. Avoid running the wiper blades over a dry windshield . . . you may scratch the glass. Spray washer fluid on it first.

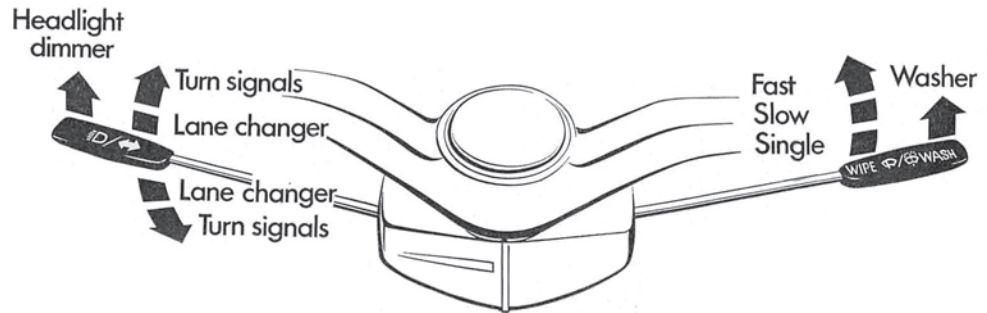

Sun visors

To protect the driver from side glare, the sun visor on the driver's side can be moved toward the door window after lifting it out of its center mounting. The sun visor on the passenger's side cannot be moved toward the side.

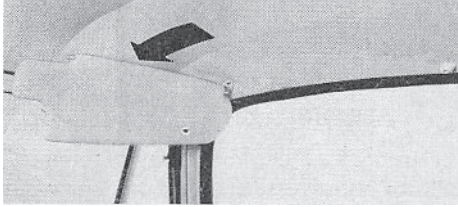

Coat hooks/Assist handles

For your convenience, there are altogether 5 coat hooks on the door posts.

Hang clothes in such a way that they do not impair the driver's vision.

For easier entrance and exit of passengers, we have provided 5 assist handles:

- 1 on the dashboard for the front passenger seat, and
- 4 in the rear passenger compartment.

Front interior light

The switch positions are:

- Front — ON (with doors open)
- Center — OFF
- Rear — ON (with doors closed)

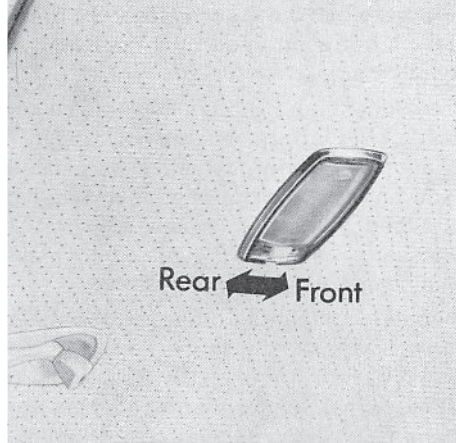

Rear view mirrors

Adjust the outside and inside mirrors before driving off. It is important for safe driving that you have good vision to the rear.

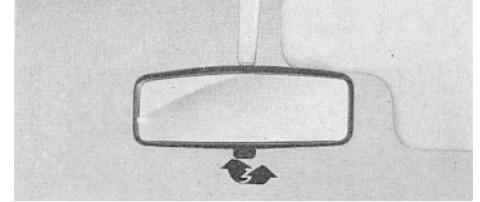

Inside day-night mirror

You can move the day-night mirror from the clear daylight visibility to non-glare visibility at night by adjusting the lever upward or downward at the bottom of the mirror.

Outside mirror

The outside mirror is hinged and folds flat against the car when struck from either direction.

Controls for Manual Transmission

1 - Clutch pedal

Always depress the clutch pedal fully when changing gears. Do not hold the car on a steep hill with the clutch pedal partially depressed. This may cause premature wear or damage.

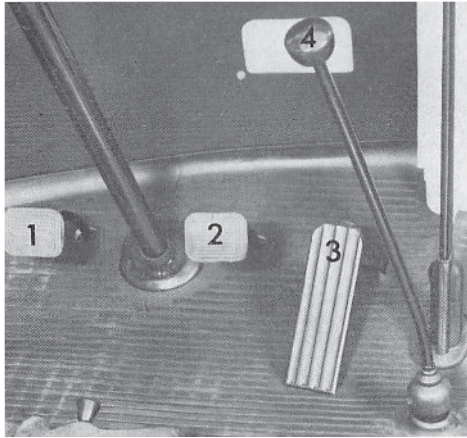

2 - Brake pedal

Make it a habit to check the operation of your brakes. You will remember from page 24 that the brake warning light will alert you if one brake circuit may have failed.

Make sure that the movement of the brake pedal is not obstructed by a floor mat, or any other object.

Volkswagen automobiles have excellent brakes, but they are still subject to wear . . . depending on how the brakes are used. If you find that the brake pedal travel has increased, have the brakes adjusted; if necessary, between the specified maintenance intervals.

Keep in mind that the braking distance increases very rapidly as the speed increases. At 60 mph, for example, it is not twice but four times longer than at 30 mph. Tire traction is also less effective when the roads are wet and slippery. Therefore, always maintain safe distance.

Driving through deep water may reduce tire traction. Moisture on the brakes may also affect braking efficiency. Cautiously apply the brakes for a test. If you notice a lag in the braking action, the brakes may be wet. They will dry after you have applied the brakes a few times, but do it very cautiously.

Brake linings may not have the highest possible braking efficiency when new. Therefore allow for longer braking distance during the initial 100 to 150 miles. This also applies when brake pads or shoes are replaced.

3 - Accelerator pedal

For good fuel economy we recommend smooth and even acceleration. Very fast, racy driving, alternating between full throttle and hard braking, raises the fuel consumption considerably. Also, tires and brake linings wear faster.

You can drive most economically between:

- 10 and 23 mph in 2nd gear
- 15 and 35 mph in 3rd gear
- 30 and 50 mph in 4th gear

4 - Gearshift lever

Your Volkswagen has a fully synchronized transmission. The four forward gears and a reverse gear are arranged as illustrated. The shift pattern is also shown on the face of your ashtray in the dashboard.

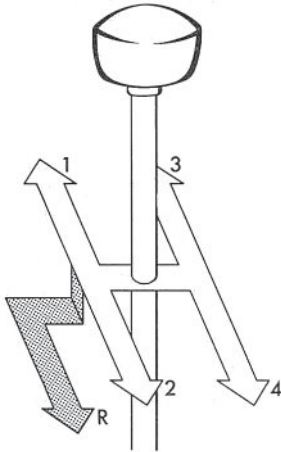

Resting your hand on the shift lever knob while driving will cause premature wear to the transmission.

Speed ranges

You can drive your Volkswagen at full speed from the first day. You do not have a break-in schedule.

There are, however, certain recommended speed ranges for the various gears:

| | |
|----------|----------------|
| 1st gear | 0—15 mph |
| 2nd gear | 10—32 mph |
| 3rd gear | 15—52 mph |
| 4th gear | from 30 mph up |

If you have a traffic situation where it is necessary to accelerate in 2nd and 3rd gear above the recommended speed ranges, you may do so for a brief period only. A governor is installed on the engine to prevent damage from excessive engine speed (revolutions per minute).

Reverse

Only shift into Reverse when the car is not moving. To engage the reverse gear, press the lever down, move it to the left and pull back.

The back-up lights go on automatically when you engage the reverse gear (with the ignition on).

5 - Parking brake

To set the parking brake, pull out the handle. To release the parking brake, first slightly pull the handle as you turn it to the right. Then push it all the way in. **Be sure the parking brake is fully released.** A partially engaged parking brake promotes wear of the brake lining.

Do not remove the key from the steering lock while the car is rolling to a stop. The steering column is locked as soon as you remove the key. Take out the key only after the car is parked.

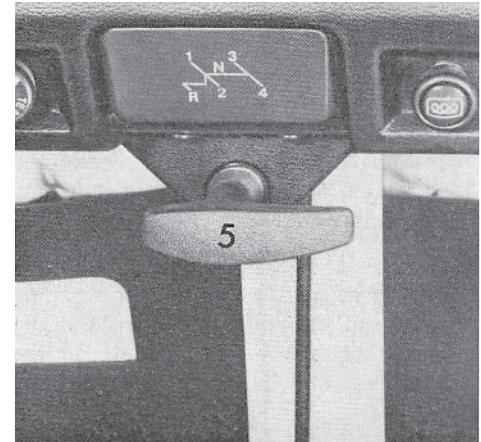

Always set the parking brake when parking your car. On steep hills also turn the wheels toward the curb.

Controls for Automatic Transmission

There are few points you should know if you want to take full advantage of your Automatic Transmission.

Remember the following basic rules:

- You can start the engine with the selector lever in Neutral or Park.
- Apply the parking brake or foot brake before selecting a driving range. When the selector lever is in a driving range, the car may creep even at an idling speed. Therefore, do not release the parking brake or foot brake until you are ready to move.
- Do not accelerate while selecting a driving range. At this time the engine must run at idling speed so that no undue stress will be placed on the automatic clutches in the transmission.
- If the selector lever is accidentally moved into Neutral (N) while driving, take your foot off the accelerator pedal and wait until the engine speed has drop-ped to idling before selecting a driving range.

The **selector lever** has 6 positions:

P = Park
R = Reverse
N = Neutral
D = Drive
2 = } Lower driving ranges
1 = }

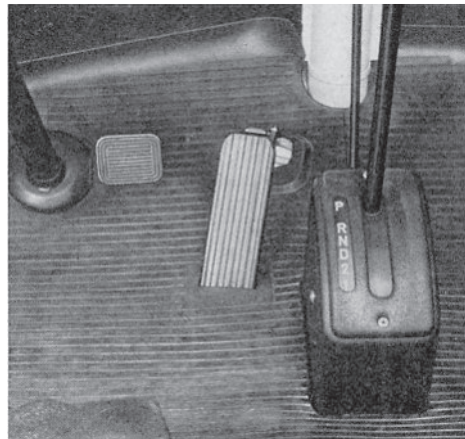

The selector lever may be shifted freely between Neutral and the ranges Drive and 2. When selecting the other ranges, observe the following:

From N to R } squeeze trigger in handle
From R to P } and push lever forward.
From P to R } squeeze trigger in handle
and pull lever back.
From R to N } **just pull lever back.**
to D to 2 }
From 2 to 1 } squeeze trigger in handle
and pull lever back.
From 1 to 2 } **just push lever forward.**
to D to N }

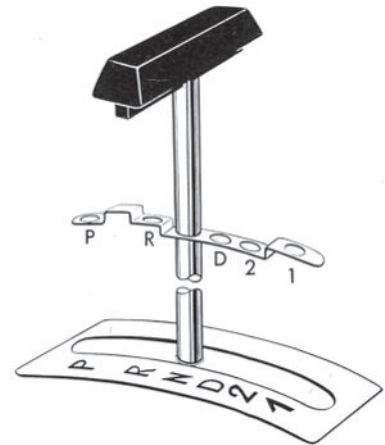

The selector lever console is illuminated when the parking or headlights are switched on.

The driving ranges

The Automatic transmission has 3 forward driving ranges and one reverse. In the selected driving ranges, the Automatic transmission changes gears automatically while driving.

Range D

is the driving range to be normally used for day-to-day driving and highway driving. It ranges from zero to top speed, and all three gears engage automatically while driving.

Ranges 2 and 1

are to be used for mountain driving or slow driving, and also when you want to make use of the engine's braking effect.

Range 2

Should only be used up to 55 mph. In "2", only the first and second gears will engage automatically. Therefore, only shift down into driving range "2" when the car speed is below 55 mph. It is not necessary to let up on the accelerator.

Range 1

Range 1 is needed on rare occasions, such as steep mountain driving. The first gear engages immediately upon selecting "1". In "1", the transmission will stay in first gear and not shift into second or third. Therefore, **do not select "1" when driving more than 30 mph.**

An interlock prevents inadvertent shifting into Range 1. When selecting "1", squeeze the trigger in the handle and pull the lever back. When shifting back into 2, just push the lever forward.

The reverse driving range

should be selected only when the vehicle is stationary and without depressing the accelerator. To select reverse you must squeeze the trigger in the handle and push the lever forward. To move the lever back to Neutral, just pull the lever back.

Accelerator "Kickdown"

If you need quick acceleration to pass moving vehicles or to climb steep grades, make use of the accelerator "kickdown" in your VW with Automatic Transmission. It gives you the possibility to shift into a lower gear without moving the selector

lever. The accelerator kickdown can only be applied with the selector lever in the driving ranges D and "2".

When depressing the accelerator pedal you will find resistance at the full throttle position. By applying greater pressure the pedal can be pushed beyond this point to the kickdown position. The transmission will now shift automatically into the next lower gear to give you maximum acceleration, and only shift up again after the engine has reached maximum speed in that particular gear.

Be careful when using the kickdown on icy roads. Rapid acceleration may cause skidding.

Please observe the following when applying the accelerator kickdown:

With the selector lever in D, you can apply the kickdown to make the transmission shift down into second gear when driving below 50 mph and down to first gear when driving below 30 mph. With the selector lever in "2", you can apply the kickdown to make the transmission shift down into first gear when driving below 30 mph.

As soon as you release the pedal from the kickdown position the next higher gear is automatically selected.

Starting the engine

is only possible when the selector lever is in Neutral or Park. As long as one of the driving ranges is engaged a safety switch prevents the engine from being started. For further details on starting see pages 23 and 33.

Moving off

With the parking brake or foot brake set, shift into the range you wish to use, usually position D. To move off, release the brake and accelerate.

Do not release the brake before you are prepared to move, because power is transmitted to the wheels as soon as a driving range is selected.

Selecting a driving range

is easy. Simply release the accelerator pedal and move the selector lever from the range you were in to the range you want. Then step on the accelerator again. To select Range 1, see pages 30 and 31.

Stopping

When stopping temporarily, at traffic lights for example, it is not necessary to move the selector lever to Neutral. Simply apply one of the brakes. To start off again, release the brake and accelerate.

Maneuvering

When alternating between forward and reverse drive — for instance, while maneuvering the car into a tight parking space — only shift into Reverse or Drive when

- the car has come to a full stop,
- and the engine is running at idling speed.

Mountain driving

When driving on long, steep and winding mountain roads select range 2 or 1.

Parking

Do not remove the key from the ignition/steering lock until you have parked the car, because removal of the key locks the steering.

When parking your car, apply the parking brake and move the selector lever to position P. To do this, squeeze the trigger in the handle and push the lever forward to the Park position. The transmission is then mechanically locked.

The Park position may only be engaged when the car is stationary.

Emergency starting

Your Volkswagen with Automatic Transmission **cannot be started by pushing or towing**. Should the engine fail to start consult your nearest Authorized Volkswagen Dealer.

Starting hints

Fasten safety belts!

Never start or let the engine run in an enclosed unventilated area. Exhaust fumes from the engine contain carbon monoxide which is colorless and odorless. Carbon monoxide, however, is a very harmful gas, and can be fatal if inhaled.

Before turning the ignition key, make sure the gearshift lever is in Neutral (Manual Transmission). The Automatic Transmission can only be started in **Neutral** or in **Park**.

As soon as the engine starts, release the ignition key.

If the engine does not start the first time or stalls, turn the ignition key all the way to the left and restart.

Operate the starter for a few seconds only.



Summer starting

Operate the starter while slowly depressing the accelerator pedal.

Winter starting

First depress the accelerator pedal fully and release slowly to activate the automatic choke. Then start the engine.

On the Manual Transmission, also depress the clutch pedal when starting so that the starter only has to crank the engine.

Do not try to warm up the engine by letting it idle with the car stationary . . . drive off immediately and maintain moderate speed until the engine is warm.

Starting the engine at operating temperatures

Before operating the starter, depress the accelerator pedal fully . . . **do not release it**. Now start it.

Ashtrays

You will find one ashtray in the front on the instrument panel and two in the rear passenger compartment.

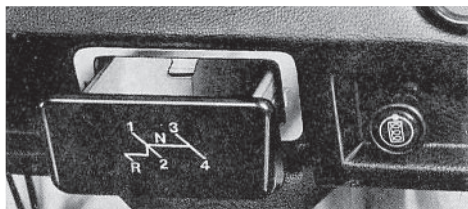

Front Ashtray

Pull to open it. You can remove the ashtray by depressing the leaf spring and pulling the tray out.

To put it back in, depress the leaf spring, insert the tray in the guide and push in with the heel of your hand.

Ashtrays in the rear passenger compartment

To remove it press down on the tray and pull out. To put it back, insert the bot-tom of the tray first, then push in.

Sliding roof (optional equipment)

To open the sliding roof, pull the handle out and turn it counterclockwise; to close the sliding roof, turn the handle clockwise. The sliding roof is locked in any open position.



For safety reasons, fold the handle back into its recess, as shown in the illustration.



Heater/Defroster (1/2)

A fresh air heater/defroster is standard equipment on your Volkswagen.

The three control levers are located on the instrument panel.

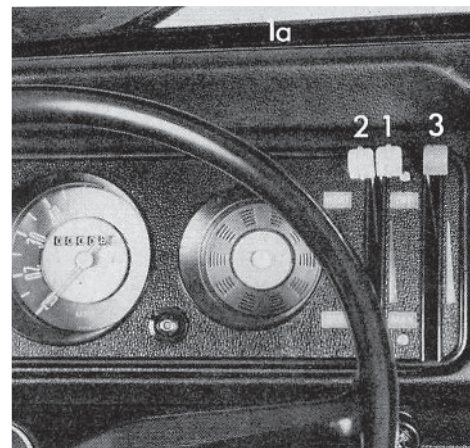

Heater temperature lever 1 (TEMP)

This right red lever controls the temperature level (OFF - MAX)

- Lever up — heat off
- Lever down — heat on fully

By setting the levers at any intermediate position, you can select the degree of heat that is most comfortable for you. After a reasonable warm-up time, which also depends on the speed of the car, warm air will enter the vehicle through the two air vents — 1a — at the lower edge of the windshield.

This lever also activates an electric fan in the engine compartment. The fan increases the flow of warm air when driving at low speeds and also supplies warm air when the car is standing still.

Heat distribution lever 2 (HEAT - DEF)

With the left red lever you can regulate the flow of warm air to the front leg area and to the rear passenger compartment.

- Lever up —
Front and rear footwells fully open
- Lever down —
front and rear footwells closed

You can select any intermediate position to regulate the heat for the front and rear.

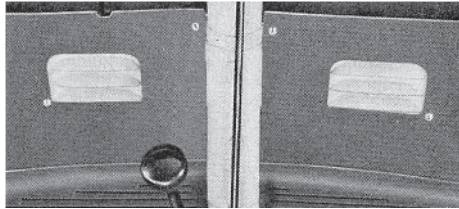

The warm air outlets for the front leg area are underneath the dashboard. The heat outlets for the center seats in the rear passenger compartment are on the floor in front of the seats; and those for the rear seats are underneath the center seats.

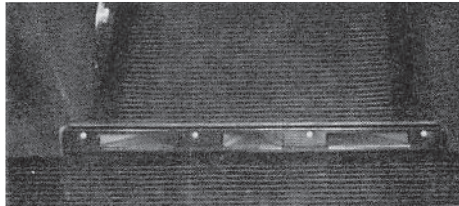

Hints for defogging and defrosting

Defogging and defrosting your windshield will be more effective if you direct the total air flow toward the front.

Here is what you do:

Heater temperature lever 1 (TEMP) on dashboard all the way down (MAX)
— heater is fully on

Heat distribution lever 2 (HEAT-DEF) on dashboard all the way down
— no heat to the rear and to the front leg area

To add fresh air, as needed,
move blue lever down
— ventilation on

Now all air is directed toward the windshield.

Ventilation (3)

The fresh air circulation system provides a continuous draft-free exchange of air while driving.

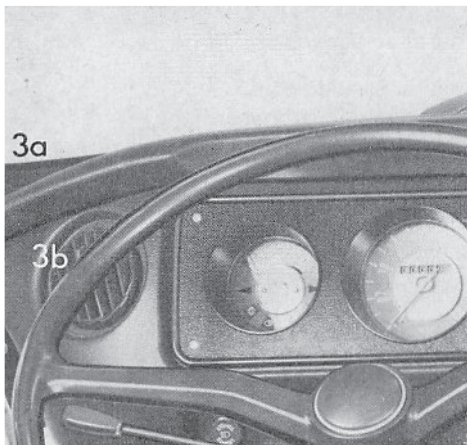

With the blue lever — 3 — on the dashboard you can regulate the flow of fresh air.

Lever up — ventilation off
Lever down — ventilation on

Fresh air enters through two vents — 3a — below the windshield and two round discharge vents — 3b — on the sides of the dashboard. You can regulate the flow of fresh air from the round discharge vents in any direction by turning

them. You can open and close these vents by adjusting the flap in the vents.

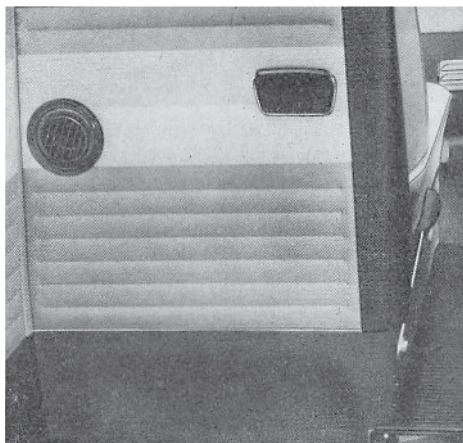

Two additional discharge vents are located on the partition between the driver's cab and the rear passenger compartment. They are individually adjustable and provide fresh air ventilation toward the rear.

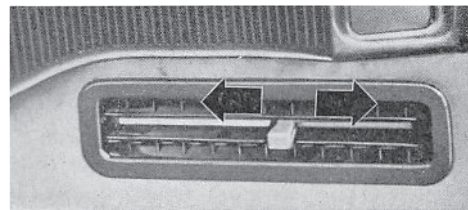
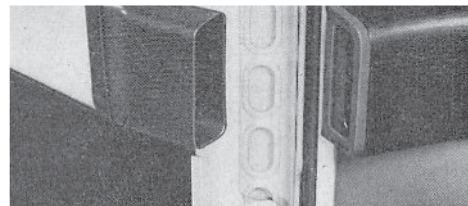

Air that enters the interior of the car via the fresh air circulation system is drawn out through openings in the front door frames. The air flow can be regulated by levers in the inside panel of the front doors.

Lever to the front —
fresh air circulation on
Lever to the rear —
fresh air circulation off

VW Air Conditioner (optional equipment)

Operating Controls

1 - Air volume switch ("AIR")

This switch serves two functions. It turns the air conditioning system on and off and controls the fan speed. The fan positions are:

- 1st position — HIGH
- 2nd position — MEDIUM
- 3rd position — LOW

2 - Air temperature control ("TEMP")

By progressively turning the control to the right, the desired cooling range can be selected. It is in the coldest position when turned as far as possible to the right.

3 - Air discharge louvers

The two rectangular louvers (3a) can be adjusted by moving the vanes up, down or sideways to direct the air flow for the front seats in the desired direction.

The six round louvers (3b) are adjustable by turning them clockwise or counter-clockwise.

The four ball type outlets (3c) can be rotated in their sockets to any position to direct cool air into the passenger compartment as desired.

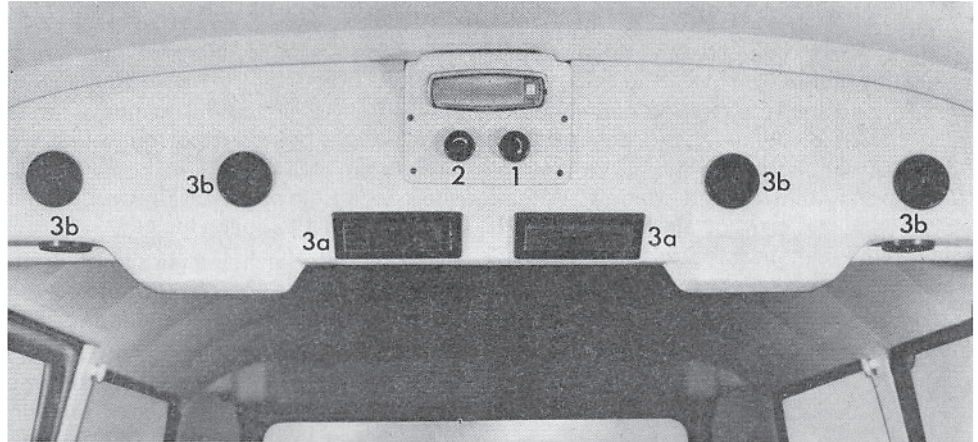

Station Wagon: View from the front

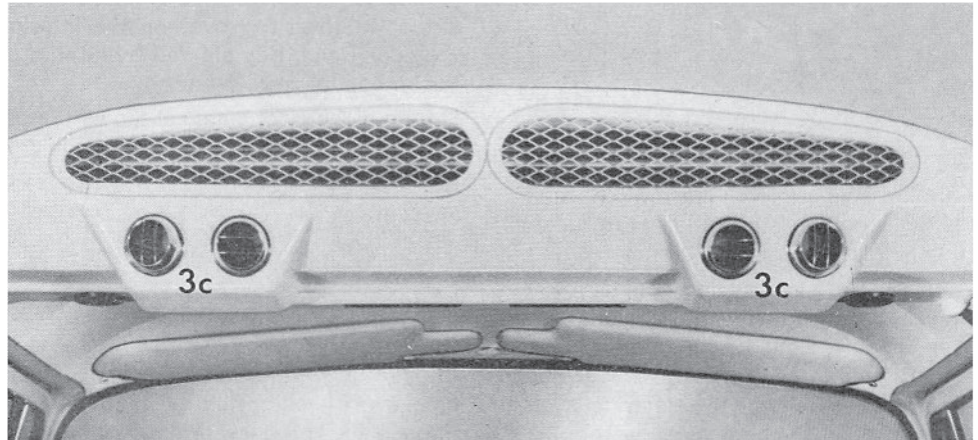

View from the rear

Starting the Air Conditioner

With the windows closed and the fresh air ventilation turned off, turn the air temperature control to the desired position and select the air volume speed desired. On extremely hot days turn the air volume to full capacity and open a window. Within a few minutes, the hot air will be forced out of the car and the window can be rolled up as cooling starts.

Adjust the air discharge louvers to the desired position.

Stopping the Air Conditioner

Turning the air volume switch to the "OFF" position stops the entire air conditioning system.

When restarting a stalled engine, it is not necessary to turn off the air conditioner. The current to the air conditioner is interrupted during the starting process. This is to reduce the load on the electrical system and conserve the battery.

Operational hints

For best overall comfort do not aim the air flow directly at a person, but allow the cooling air to circulate throughout the vehicle. Avoid pointing the round ball type outlets towards the ceiling. In this position the cooling air might be drawn back into the unit without cooling the car.

If the car interior becomes too cold after adjusting the air volume, turn the air temperature switch to the left until the desired comfort level is reached.

If the windows fog over on the **exterior** on warm humid days, turn the air temperature control to the left until the windows clear up, or turn the windshield wipers on. If the windows fog over on the **interior**, they can be quickly cleared by turning on the air conditioner.

During highway driving, set the air temperature control in approximately the middle position.

Maintenance hints

During the winter season, it is advisable to operate the Air Conditioner for a short time every week. This will help to keep the seals and fittings properly lubricated.

After the winter months and before extended summer usage, the air conditioner should be checked and, if necessary, serviced by an Authorized VW Dealer.

The condenser should be checked periodically for cleanliness. If the condenser is clogged with dirt or insects, it should be washed down with water.

If the condenser is bent, the car should be taken to an Authorized VW Dealer for straightening of the condenser fins.

An air-conditioned Volkswagen should only be raised on a lift that provides adequate clearance to prevent damage to the refrigerant hoses.

Circuit breaker

An automatic resetting circuit breaker for the current supply of the air conditioning system is located in the engine compartment. It is connected directly to the battery.

Vehicle weights

When a VW Air Conditioner is installed, the permissible load will be reduced. A sticker behind the driver's seat points out this fact.

VW Auxiliary Heater

(optional equipment)

The auxiliary heater can be operated without turning on then engine. However, when it is very cold we recommend you start the engine first as the full battery capacity is required for starting the engine under cold weather conditions.

Do not start or let the engine or heater run in an enclosed, unventilated area to warm up the car. Exhaust fumes from the engine or gasoline heater contain carbon monoxide, which is colorless and odorless. Carbon monoxide, however, is a very harmful gas, and may be fatal if inhaled.

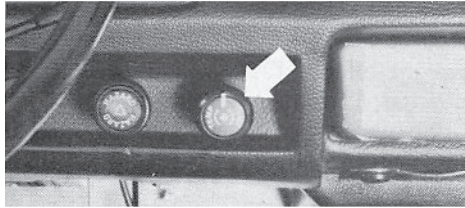

To turn the heater on, turn the green heater switch on the dashboard slightly to the right.

The Auxiliary Heater must be turned off when filling the tank.

With the knob on the front right hand side under the driver's seat you regulate the temperature. Pull it out all the way or to

an intermediate position to set the desired heat range. A light in the heater switch on the dashboard will glow when the parking lights or headlights are turned on.

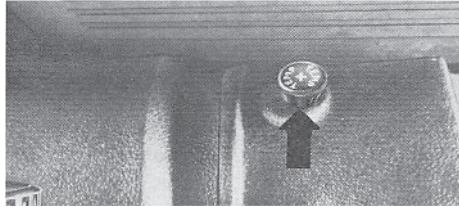

To turn the heater off, turn the heater switch on the dashboard to the left. The light in the switch then goes out. The blower motor continues to run until the heater has cooled down.

There is a **timer** in the heater switch, which gives you the possibility to **preheat the vehicle interior** for a set period of time before starting the engine.

To set the timer, turn the heater switch further to the right. The maximum sweep of the timer constitutes about 25 to 30 minutes of heater operation. You can, of course set the timer at any desired intermediate position.

As soon as the timing cycle is completed, the heater will shut itself off. If you start the engine before the timing cycle is completed, the heater will continue working, and can then be turned off manually, whenever desired.

To give you full battery power, the heater should not run while starting the engine.

Within the timing cycle switch the heater off manually before restarting the engine.

The heater normally requires no special **maintenance**. It is advisable, however, to have the heater plug and spark plug checked once a year before the cold weather sets in and new plugs installed if necessary. The fuel system should also be checked for cleanliness and the electrical connections for tightness.

During the winter and when driving over very poor roads, mud or snow may tend to accumulate in the exhaust and combustion air intake pipes. Have these pipes checked for blockage from time to time so that the heater can continue to work properly. When the heater is not used for long periods, for instance, during the summer, the fuel in the heater can evaporate. It is therefore advisable to operate the heater briefly about once a month when it is not in regular use.

Heat output — 4320—1600 BTU/h
Temperature range — 104°—275° F
Fuel — gasoline from fuel tank

Fuel consumption
0.35—1.1 pints/h (0.3—1.0 Imp. pt./h)

Power consumption — 50 watts

Towing and trailer hauling

Always observe state laws and municipal ordinances governing towing.

We provided your Volkswagen with towing eyes at the front and rear. They are for emergency towing over short distances only.

When you tow your VW with the engine not running, the brake booster does not assist the braking force. To get the full braking effect, the driver must apply more force to the brake pedal.

Manual Transmission

When towing your Volkswagen with Manual Transmission, place the gearshift lever in Neutral. Turn the ignition on to be able to operate parking light, turn signals and stop lights. Be sure to release the parking brake.

Automatic Transmission

When towing your Volkswagen with Automatic Transmission, please also observe the following in addition to the items listed under Manual Transmission.

The towing speed should not exceed 30 mph, and the towing distance should not be longer than 30 miles. This is very important because the transmission will not be adequately lubricated due to the lack of oil pressure normally provided when the engine is running. These limitations do not apply if the car is lifted at the rear or if the drive shafts are disconnected.

Please keep in mind . . .

The towing eyes on your Volkswagen are not designed for towing by commercial tow trucks. Also, never have your VW towed by the bumper.

The driver of the towing car must be very careful when driving off and shifting to avoid sudden and abrupt jerks.

The driver of the towed car must always keep the tow rope taut.

Trailer hauling

It is not possible to tow a trailer with your Volkswagen with Automatic Transmission.

When towing a trailer with your Volkswagen with Manual Transmission always shift to a lower gear when driving up or down steep hills with this extra load.

The total weight of a trailer (without brakes) should not exceed 1100 lbs.

The trailer tongue load should be 55 to 110 lbs. Distribute load in the trailer evenly.

And remember: the additional trailer weight affects the braking of your car so that a longer distance is needed to bring the car and trailer to a stop. Test the brakes before starting out on a trip with a trailer.

Winter operation

Battery

During the winter months, the battery is subjected to greater use than in the summer months. More current is consumed when starting at very low temperatures. Lights and the rear window defogger are used more often. Besides, the battery tends to decrease in capacity as the temperature drops.

Therefore, it is very important to keep your battery in the best possible condition. See also “Battery” on page 50.

Do not expose battery to open flame or electric spark as hydrogen gas generated by the battery is explosive. Do not let battery acid come in contact with skin, eyes, fabric or painted surfaces.

If you mainly drive short distances or in city traffic, have the battery checked and, if necessary charged between regular inspections.

Emergency equipment

It is good planning to carry emergency equipment in your car. Some of the things you should have are: window scraper, snow brush, container or bag of sand or salt, flares, small shovel, first-aid kit, etc.

Door locks

can freeze in the winter if water gets into them. When washing your car in the winter, do not aim the water jet directly at the locks. It is a good idea to put tape over the keyholes to prevent the water from seeping in. Water in the locks must be removed with compressed air afterwards. Squirt lock de-icer, anti-freeze, or glycerine into the lock cylinders to prevent the locks from freezing.

To open a frozen lock, warm up the key before inserting it. It might also help to warm the lock. Do not use hot water as it will later freeze in the lock.

Windshield washer

Add anti-freeze to the washer fluid, such as Volkswagen’s Windshield Washer Anti-Freeze and Solvent, to prevent it from freezing. Follow the instructions on the can for the right amount to be used.

Engine oil

To make starting easier during the cold winter months, we suggest you choose a thinner grade motor oil. Turn to page 63 for the recommended oil grades.

If you drive mostly short distances and in city traffic, we recommend you have your engine oil changed at 1500-mile intervals in the winter.

Transmission oil

SAE 90 grade transmission oil can generally be used all year round. Only in areas with a cold climate is it necessary to use the thinner SAE 80 transmission oil during the winter months.

In arctic climate and areas with temperatures consistently below -13° F, use Automatic Transmission Fluid (ATF) for the manual transmission and final drive. This does not apply to the final drive of the Automatic Transmission. When the temperature rises, replace the ATF with SAE 80 or SAE 90 grade transmission oil. See also page 64.

Spark plugs

Make sure the spark plugs are not worn or have a gap larger than 0.028 inch. For further details on spark plugs see page 57.

Tires

Your Volkswagen is equipped with tubeless radial ply tires. Volkswagen tires conform to all applicable U.S. Federal Motor Vehicle Safety Standards.

Tire pressures

For good car handling and long service life, it is important to maintain recommended tire pressures. Tires which are inflated above or below specifications can cause increased tire wear, increased gas consumption and affect the road holding of the car.

VW-recommended cold tire inflation pressures are listed on a sticker behind the driver's seat.

For road use

do not exceed the maximum tire inflation pressure listed on the tire label.

In the interest of safety, check the tire pressure of all tires, including the spare tire, at least once a week, and always before going on a long trip.

Spare tire pressure

The pressure of the spare tire should be 40 psi (2.8 kg/cm²). For road use, the pressure in the spare tire should be adjusted as specified on the sticker behind the driver's seat.

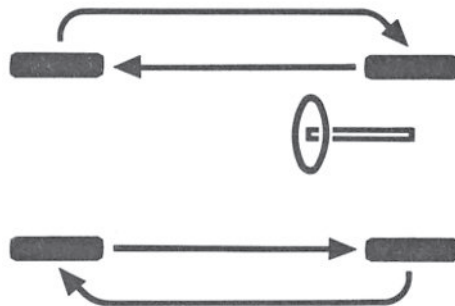

Tire rotation

If uneven tire wear should occur, we recommend that the tires be rotated as shown in the sketch above. Afterwards, the tire pressures must be corrected, and the wheel nuts torqued diagonally to 90—100 ft. lbs. Also see page 47.

Wheel balancing

A wheel should always be balanced after a tire repair. Also, since regular use can cause tire imbalance, the wheels should be balanced from time to time. Unbalanced wheels may affect car handling and tire life.

Tire wear

The original equipment tires on your VW have built-in tread wear indicators. They are molded into the bottom of the tread grooves and will appear as approximately $\frac{1}{2}$ inch bands when the tire tread depth becomes $\frac{1}{16}$ of an inch. When the indicators appear in two or more adjacent grooves, it is time to replace the tires. We recommend, however, that you do not let the tires wear down to this extent. Worn tires cannot grip the road surface properly, and are even less effective on wet roads.

Do not drive with worn tores or tires showing cuts or bruises as they may lead to sudden deflation.

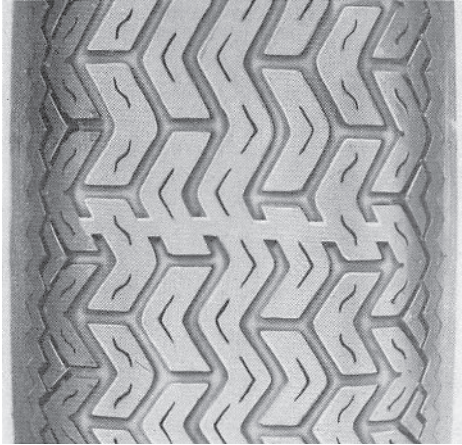

Indicator visible - tread worn

If you notice that tires are wearing unevenly, consult your Authorized VW Dealer. Uneven wear may not always be due to improper wheel alignment. It can be the result of individual driving habits such as cornering at high speeds if the tire pressure is not checked and adjusted regularly, abnormal tire wear can also occur.

Tire replacement

To achieve best all-around car handling, replace all 4 tires at the same time. If this is not possible, replace tires in pairs, either front or rear.

For maximum safety, always buy replacement tires that show the same specifications with regard to tire size, load carrying capacity, tread pattern, etc. This also applies to VW-recommended alternate replacement tires.

The specifications are imprinted on the sidewall of the tires. If in doubt, check with your Authorized VW Dealer.

New tires do not possess maximum traction. They tend to be slippery. Break new tires in by driving at moderate speed for the first 60—100 miles.

Winter tires

Winter tires give good traction in snow or slush.

For a better grip on hard snow or ice, you can use snow tires with studs, but **check with your State Motor Vehicle Bureau** for possible restrictions. Winter tires with studs should be run at moderate speed when new to give the studs time to settle.

Winter tires should preferably be mounted on all four wheels. They should also conform to the same load requirements as original equipment tires.

Inflation pressures for winter tires are listed on the sticker behind the driver's seat. **Do not exceed the maximum tire inflation pressure imprinted on the sidewall of the tire.**

Winter tires do not fulfill their purpose if the tread depth is less than $\frac{5}{32}$ " (4 mm). For safety reasons, it is not advisable to drive with winter tires at top speeds. Winter tires do not have the same degree of traction on dry, wet or snow-free roads as regular tires.

Tire care

- 1 - Frequently check tires for damage. Remove embedded material.
- 2 - Keep oil and gasoline away from area.
- 3 - Replace worn tires in time.
- 4 - Replace missing valve dust caps as soon as possible.

Spare wheel

Location in rear luggage compartment

The spare wheel is stored in the rear luggage compartment. To remove it, take off the cover and loosen the strap. When putting it back in again, be sure the plastic cap is in the shown position and tighten the strap.

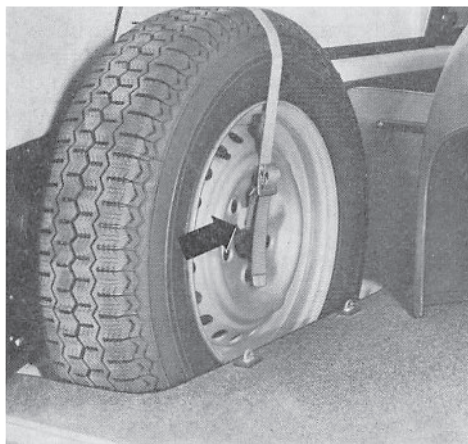

Location under front seat bench

In models with a front seat bench, the spare wheel is located under the front passenger's seat. To remove the spare

wheel, lift the front edge of the passenger seat to unhook the backrest. Fold the backrest forward, and move the seat approximately 1 inch forward. Reposition the safety belts. Turn the seat toward the door. Take out the spare wheel from the driver's side.

(See page 20 on how to install the front passenger seat.)

Spare tire pressure

Check the tire pressure from time to time and maintain it at a maximum of 40 psi (2.8 kg/cm²).

Whenever you have to use the spare wheel, adjust the tire pressure as specified on the sticker behind the driver's seat.

Jack

Warning

The jack is only to be used for changing a wheel. Do not use it as a support to work underneath the car.

The jack and the tool kit are in a bag and stowed under the front passenger seat. See page 20 on how to remove and reinstall the seat.

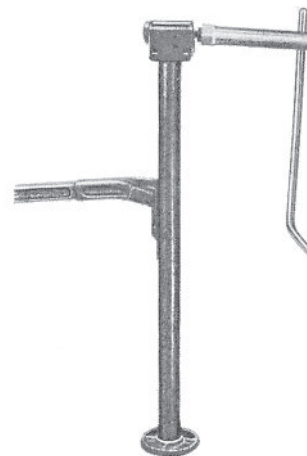

A breaker bar and socket wrench necessary to operate the jack are in the toolkit.

Changing a wheel

If you have a flat tire, **move off the roadway. Turn on the emergency flasher. In addition, mark the position of your car with flares or other warning devices to alert other motorists.**

Before you change a wheel, be sure **the ground is level and firm, especially** where the **jack ports** are.

Set the parking brake and block the wheels opposite the defective wheel on the other side of the car.

For more efficient and safe changing of a flat tire, observe the following 10 steps.

Later we expand on these steps in greater detail.

Step 1 - Take out the tools, jack and spare wheel.

Step 2 - Remove hub cap.

Step 3 - Loosen wheel nuts. **Do not take them off.**

Step 4 - Securely insert the jack in jack port. There are two jack ports on each side of the car body.

Never jack the car up by the bumper or the body.

Step 5 - Jack up car.

Step 6 - Change wheel and handtighten wheel nuts.

Step 7 - Lower car.

Step 8 - Further tighten the wheel nuts.

Do not overtighten.

Important: Torque adjustment.

Step 9 - Replace hub cap.

Step 10 - Correct the air pressure of the tire you have just put on.

Step 1

Take out the bag with kit and jack from under the front passenger seat. Lift the front edge of the seat to unhook the backrest and remove the seat.

Step 2

With the wheels still firmly resting on the ground, remove the hub cap of the defective wheel.

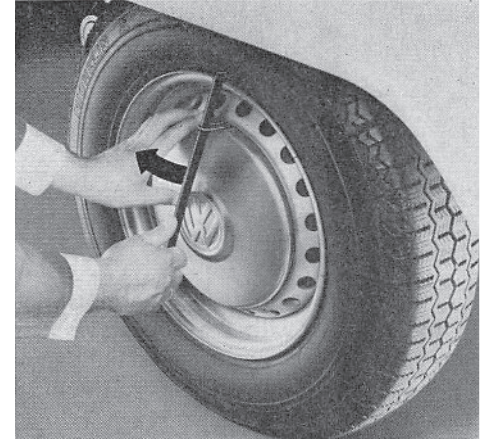

Insert the puller in the holes at the rim of the hub cap. Put the breaker bar through the puller, brace one end of the bar on the wheel rim and lightly tug on the other end.

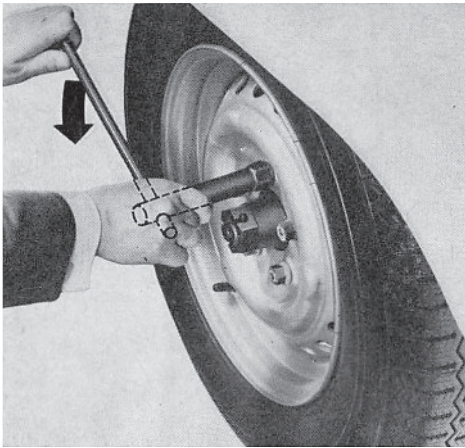

Step 3

Loosen all wheel nuts counterclockwise about one turn with the socket wrench. Insert the breaker bar to make full use of its leverage. **Do not yet remove the nuts.**

Provide a firm base for the jack on the ground. If necessary, use a board. Passengers should not remain in the car when the car is jacked up.

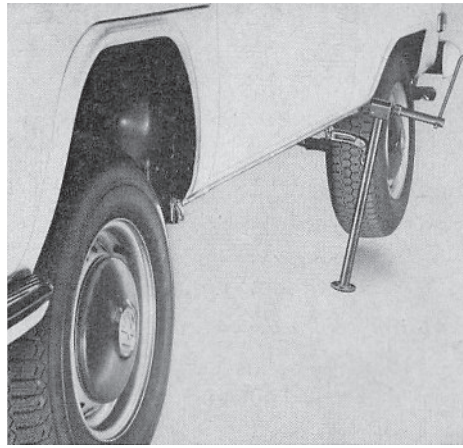

Step 4

Securely insert the jack into the jack port closest to the wheel to be changed. There are two jack ports on each side under the car body for front and rear wheel changing. **Never jack the car up by the bumper or body.**

Step 5

Do not raise the car until you are sure the jack is securely engaged.

Raise the vehicle by turning the hex drive clockwise with socket wrench and breaker bar.

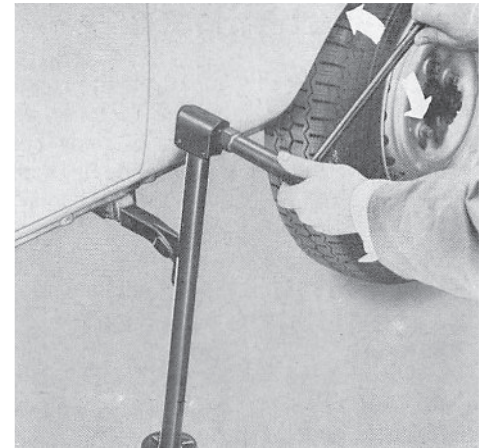

Only raise the vehicle as much as is needed to change the wheel.

Step 6

Fully unscrew the wheel nuts and place them into the hub cap. Take the nut at the top off last. Place the spare wheel against the wheel hub and slightly rotate the wheel until a bolt hole in the wheel is in line with a threaded bolt in the wheel hub. Reinstall the nuts and tighten them crosswise by hand before jacking the car down.

Step 7

To lower the vehicle, turn the hex drive counterclockwise with socket wrench and breaker bar.

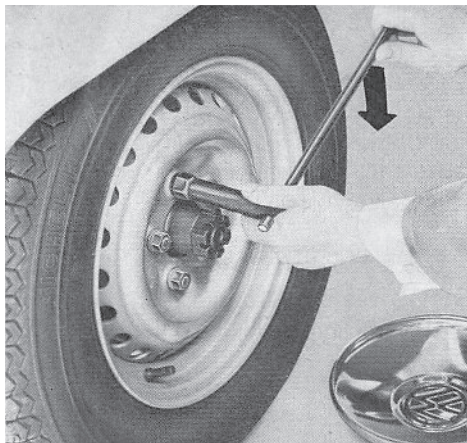

Step 8

Then go crosswise from one nut to another tightening them firmly with the socket wrench and breaker bar.

Correct tightness of the wheel nuts is important.

Correctly tightened nuts should have a torque of 90–100 ft. lbs. This torque can be obtained with the socket wrench and breaker bar by any person of average strength. If in doubt about the correct tightness of the wheel nuts, have it checked with a torque wrench by your dealer or at a service station.



Step 9

To install the hub cap, place it around the lower part of the wheel center. With a firm blow of your hand on the upper part, the hub cap will snap into place. Make sure it is properly seated.

Step 10

Adjust the air pressure of the tire you have just put on. For correct tire inflation pressures, see the sticker behind the driver's seat.

Store the jack and tool kit under the front passenger seat. See page 20 for instructions on how to reinstall the seat.

Container for windshield washer fluid

It is located on the right under the dashboard and has a capacity of 2.9 U. S. pints (2.4 Imp. pt.).

As clear water is usually not adequate for cleaning the windshield, add a cleaning solution to the water such as Volkswagen's Windshield Washer Anti-Freeze & Solvent. It is a concentrate, so follow the directions on the can for the correct amount to be used.

You can use Volkswagen's Windshield Washer Anti-Freeze & Solvent all year round. It helps to keep your windshield clean, and prevents freezing of the washer fluid in the winter.

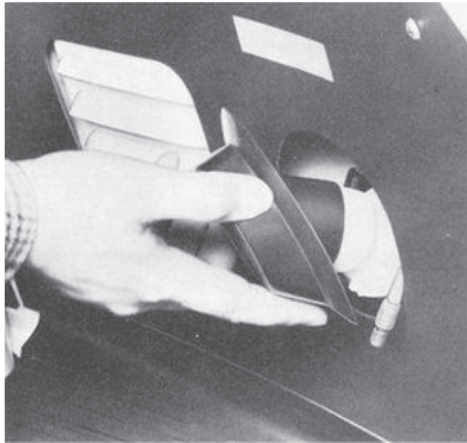

After filling the windshield washer container, screw the cap on tightly.

Pressurize the container up to a maximum of 42 psi (3.0 kg/cm²) by attaching the hose from the air pump to the container hose.

Place plastic cover over container cap.

Brake fluid reservoir

It is located under the driver's seat. You can check the brake fluid level through a cut-out in the cover.

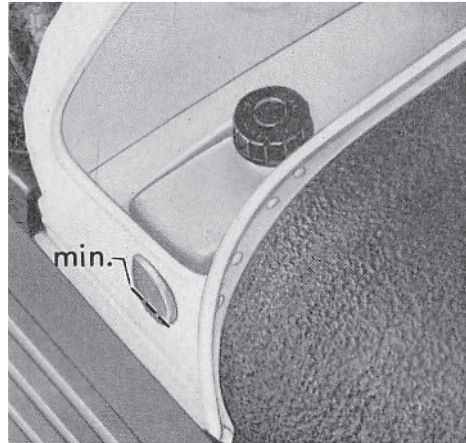

The brake fluid should always be between the upper and lower edge of the reservoir. If it drops below the lower edge, the cause should be corrected by your Authorized Volkswagen Dealer.

Every 2 years, the brake fluid has to be replaced. See "Additional Services Record" on pages 83 and 78.

Only **new, unused** brake fluid that meets the SAE recommendation J 1703 and conforms to Motor Vehicle Safety Standard 116 must be used.

Under the driver's seat, there may be no luggage stored which could damage the brake fluid reservoir.

Fuses

The 12-point fuse box with plug-in arrangement for relays is located under the instrument panel on the right hand side of the steering column. When a fuse is blown, it is not sufficient to merely replace it. The cause of the short circuit or overload must be found.

On no account should fuses be patched up with tin foil or wire as this may cause serious damage elsewhere in the electrical circuit. It is advisable to always carry a few spare 8 amp. and 16 amp. fuses in your car.

Additional fuses

The 8 amp fuse for the back-up lights is located in the engine compartment on a support near the ignition coil (arrow)**.

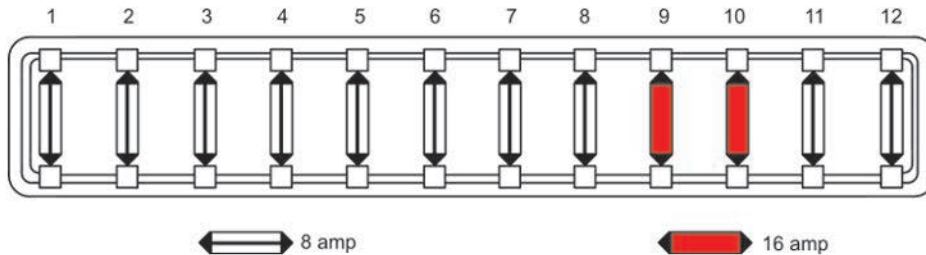

There are ten 8 amp. fuses (white) and two 16 amp. fuses (red). No. 9 and No. 10 are the two 16 amp. fuses.

- | | |
|--|--|
| 1 Tail light left, side marker light left | 8 Emergency flasher, interior light at front |
| 2 Parking lights, side marker light right, license plate light, tail light right | 9 Interior light at rear, buzzer alarm, Auxiliary heater* (switch current) |
| 3 Low beam left | 10 Windshield wipers, rear window defogger, Auxiliary heater* (switch current) |
| 4 Low beam right | 11 Turn signals, warning lamps for alternator, oil pressure, fuel gauge, kick-down (Automatic Transmission only), back-up lights (Automatic Transmission only) |
| 5 High beam left, high beam indicator light | 12 Horn, stop lights, brake warning light |
| 6 High beam right | |
| 7 Accessories | |
- * optional equipment

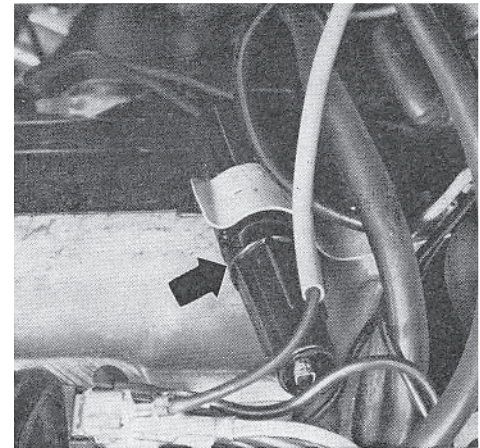

** Manual transmission only

Battery

The 16 amp fuse for the **warm air blower** is located in the engine compartment near the blower motor.

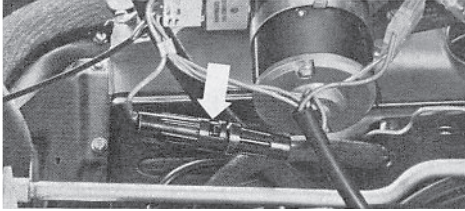

The 16 amp fuse for the **auxiliary heater*** is located in the engine compartment near the heater.

The electrical system and the ability of the engine to start readily depends to a great extent on the battery. Therefore, the battery should be checked regularly and kept in good working condition.

The battery is located in the engine compartment on the right hand side and should

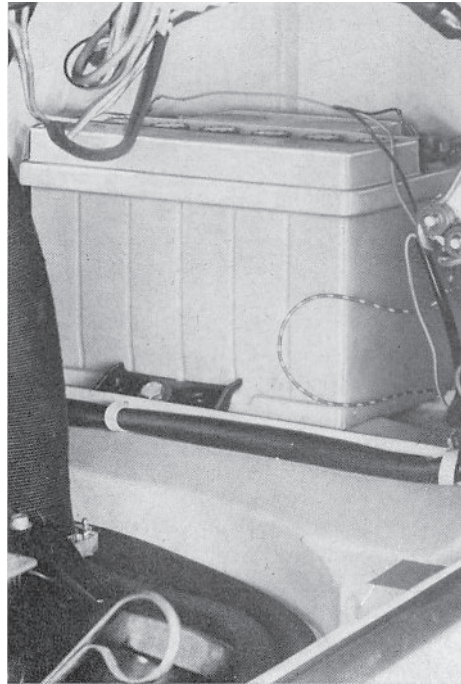

be taken out for checking and maintenance purposes.

To **remove** the battery, take off the plastic cover. Disconnect the battery ground strap (leave wire attached) and then the terminal from the positive post. Disconnect the center wire (electrolyte level sensor for diagnosis). Remove the front clamp. **Be sure the battery filler caps are in place before** taking the battery out.

When reinstalling the battery, be sure to reconnect the center wire to the battery. Do not interchange with the other wires.

Do not expose the battery to an open flame or electric spark. Hydrogen gas generated by the battery is explosive. Do not let battery acid come in contact with skin, eyes, fabric, or painted surfaces.

Each filler plug has to be unscrewed to check the fluid level in each cell. If it is **below** the indicator, top it up with distilled water. **Only fill up to the indicator.**

How often water must be added to the battery depends mainly on operating conditions and on the time of year. As a general rule, the battery electrolyte level must be checked more often in the summer than in the winter, and more often when driving long distances.

* optional equipment

Fuel supply

Before reinstalling the battery, clean all terminals and connections. Remove corrosion. Put the battery in its stowage position and tighten the clamp firmly. Reconnect the positive cable first, then the ground strap and the center wire (electrolyte level sensor for diagnosis). Grease the terminals and battery post well with silicone spray or petroleum jelly. Keep the ground connection tight and free of corrosion.

When working on the battery, be sure not to short circuit the terminals. This would cause the battery to heat up very quickly, which could lead to damage.

Before having a quick-charge performed on a battery installed in a car, disconnect both terminals to avoid serious damage to the electronic components of the electrical equipment.

If you have not used your car for an extended period of time, you may need to have the battery recharged.

The engine requires “Regular” gasoline with a minimum octane rating of 91 (RON). In the interest of cleaner air, the VW engine is designed to run also on low-lead or lead-free gasoline. If regular fuels with adequate anti-knock qualities are not available, premium fuels should be used or mixed with the regular fuel.

When traveling outside the United States or Canada, regular gasolines may have a considerably lower octane rating. Therefore, make sure the gasoline that you are using does not have an octane rating lower than 91.

Never start or let the engine run in an enclosed unventilated area. Exhaust fumes from the engine contain carbon monoxide which is colorless and odorless. Carbon monoxide, however, is a very harmful gas, and can be fatal if inhaled.

The Auxiliary Heater (optional equipment) must be turned off when filling the fuel tank.

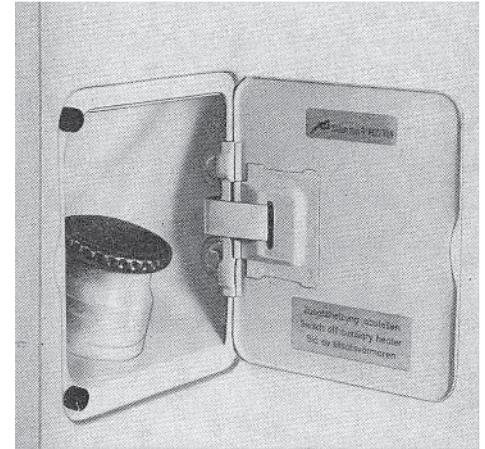

The flap for the filler neck is located above the right rear wheel.

The fuel tank has a capacity of 15.9 US gallons (60 liters or 13.2 Imp. gal.).

Cleaning your VW

The paint on your VW is very durable, and so is the upholstery. But a car can get a lot of abuse from industrial fumes and corrosive road salt, half-eaten lollipops and muddy dog feet.

A well-cared for VW can look like new 10 years later. It all depends on the owner and the amount of care he is willing to give to his car.

Here are a few hints on how to keep your VW looking young and beautiful. We have also compiled a list of cleaning products. They are available at any VW dealer.

Whenever using VW-recommended products or other cleaning agents, **follow the directions on the containers. Be aware of warning or caution labels.**

When cleaning upholstery and/or carpet, never use gasoline, kerosene, naphtha, nail polish remover or any other volatile solvents. They may be toxic or flammable and therefore hazardous. Keep all cleaning agents out of reach of children.

| Application | Volkswagen Product |
|--|---|
| Car wash and liquid wax Paint preservative | Car Wash and Wax — ZVW 243 201 Paint Preservative and Wax — 000 096 011 |
| Paint waxing Paint polishing and paint waxing | Classic Car Wax — ZVW 246 101 Combination Car Cleaner and Wax — ZVW 241 109 |
| Paint polishing, remove paint oxidation | Paint Polish — 000 096 001 |
| Preservation of chrome parts Paint touch-up | Chrome Preservation — 000 096 067 Touch-Up Paint (all colors) |
| Upholstery cleaning. Whitewall tire cleaning | All Purpose Cleaner — ZVW 243 101 |
| Windshield washer cleaning and anti-freeze | Windshield Washer Anti-Freeze & Solvent — ZVW 241 101 |

Washing your VW

The longer the dirt is left on the paint, the greater the risk of damaging the glossy finish, either by scratching if the dirt is rubbed into the paint, or simply by the chemical effect dirt particles have on the paint surface.

Therefore dirt should be washed off as soon as possible.

NEVER WASH IN DIRECT SUNLIGHT.

Use plenty of water, a car-wash soap, such as VW's Car Wash and Wax, and a soft sponge or hose brush. Begin with spraying water over the dry car to remove all loose dirt before applying the luke-warm soap/water solution.

Use plenty of water to rinse the car off well. Wipe the car dry with a chamois to avoid water spots.

Waxing

Waxing is not really needed when you have washed your car with VW's Car Wash and Wax. If you do not use a car wash liquid with wax, apply Paint Preservative and Wax to preserve the natural shine of the car.

To obtain a long lasting wax finish apply hard wax, such as VW's Classic Car Wax, eight to ten weeks after buying the car. Wax again when water remains on the surface in large patches instead of forming beads and rolling off.

Polishing

Use a polish such as VW's Paint Polish later in the car's life when the paint appears dull and loses its shine. **Do not polish the new car.**

Always apply wax after polishing.

Cleaning windows

Clean windows with a sponge and warm water. Dry with a chamois.

Weatherstrips

To seal properly, weatherstrips around windows and doors must be pliable. To retain flexibility of the rubber, spray with silicone, available from your VW dealer, or coat with talcum powder.

Windshield wiper blades

Remove the wiper blades periodically and scrub with a hard bristle brush and alcohol or a strong detergent solution.

Chrome care

To protect the car's chrome, apply VW's Chrome Preservative.

Touch-up paint

Your dealer has touch-up paint for minor scratches and stone chips. Scratches should be touched up soon after they occur.

Care of chassis

The underside of the car picks up dirt and salt and should be sprayed with a powerful jet of water.

This is easier to do after the car has been driven in the rain.

Removing spots

Do not use gasoline, kerosene, naphtha, nail polish remover or other volatile cleaning fluids. They may be toxic or flammable or hazardous in other ways. Only use spot removing fluids in well ventilated areas. Keep them out of reach of children.

Tar

Do not let tar remain on the paint finish. Remove it early with a cloth soaked with a special paint cleaner, such as Paint Preservative and Wax. If you do not have a spot remover, you may substitute with turpentine. After applying a cleaning fluid, always wash with a lukewarm soap/water solution and apply a new wax coat.

Insects

Remove early with a lukewarm soap/water solution or apply insect remover.

Tree sap

Remove with a lukewarm soap/water solution. Do not permit tree sap to harden on the paint surface.

Leatherette and interior trim

Use VW's All Purpose Cleaner or a dry foam cleaner.

Grease or paint spots can be removed by wiping with a cloth soaked with VW's All Purpose Cleaner. Leatherette parts of the headliner and side trim panels can be cleaned with a soft cloth or brush and All Purpose Cleaner.

Bulb chart

| Bulb for | US Re- placement bulbs | VW Part No. |
|--|------------------------------|-------------|
| Sealed beam (headlights) | 6014 | ZVP 118 114 |
| Front turn signal/parking lights | 1034 | ZVP 118 034 |
| Side marker lights | 57 | ZVP 118 057 |
| Rear turn signals Backup lights | 1073 | ZVP 118 073 |
| Stop/tail lights | 1034 | ZVP 118 034 |
| License plate light | 89 | ZVP 118 089 |
| Warning lights for emergency flasher brake operation rear window defogger and Auxiliary Heater . . . | — | N 17 7512 |
| Selector lever console light (Automatic trans- mission only) | — | N 17 7512 |
| Interior lights | | N 17 7232 |

Replacing bulbs

Headlights

Your Volkswagen is equipped with double filament seven inch sealed beam units. Should it become necessary to replace a sealed beam, loosen the screw of the trim ring. Firmly grasp the loose screw (non-removable) and pull the trim ring off.

Remove the three short screws in the sealed beam retaining ring and take the ring off.

Do not alter the position of the long headlight adjustment screws.

Take the sealed beam unit out of the support ring and pull the cable connector off.

When installing a new sealed beam unit, be sure the three lugs on the headlight engage properly in the support ring. Before installing the trim ring be sure the rubber gasket is in place. Loosely insert the screw for the trim ring and turn for 2 or 3 turns. Position the upper edge of the trim ring over the lug. Press the ring over the lug and tighten the screw.

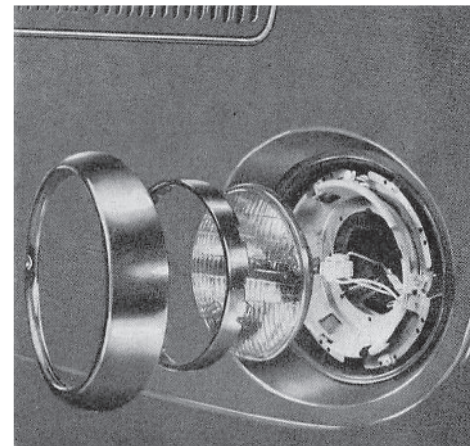

If no other headlight part as described here was removed or its position changed, it should not be necessary to aim the headlights. If in doubt have the adjustment checked by your dealer.

Front turn signal / parking light bulb

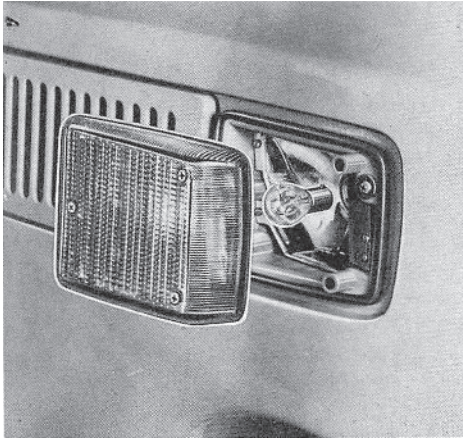

Side marker light bulb

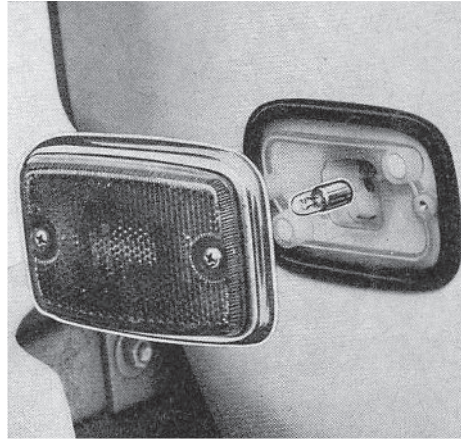

**Rear turn signal / stop / tail light bulb
or back-up light bulb**

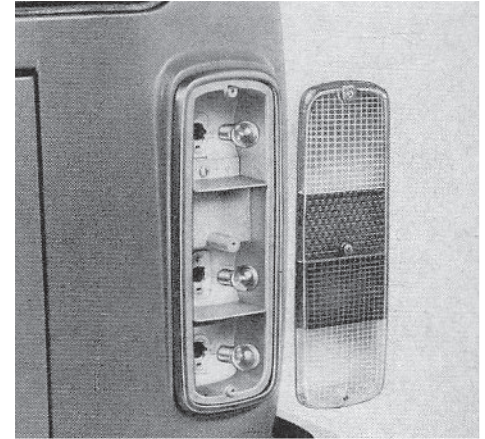

The following instructions apply to the replacement of the bulbs for the lights shown above:

Remove Phillips screws.

Take off lens.

Press bulb lightly into holder, turn it and take it out.

Install new bulb.

Be sure the gasket is properly positioned when reinstalling the lens.

Tighten screws evenly. Do not overtighten as this may crack the lens.

License plate light bulb

Open engine compartment lid.
Remove Phillips screws on each side of lens and take off lens with bulb holder.
Press bulb in lightly, turn and take out.

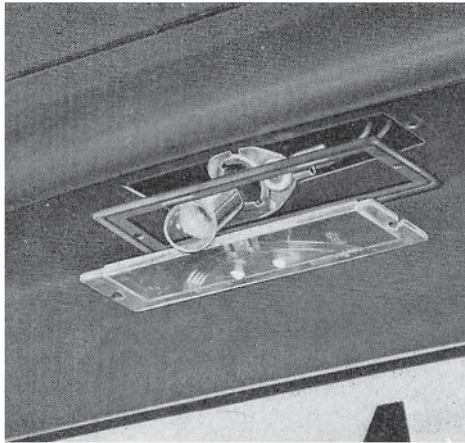

Install new bulb.
During re-assembly be sure the rubber gasket is properly seated.
Tighten screws evenly.
Do not overtighten as this may crack the lens.

Interior light bulb

Pull interior light out carefully with a screwdriver.
Take bulb out.

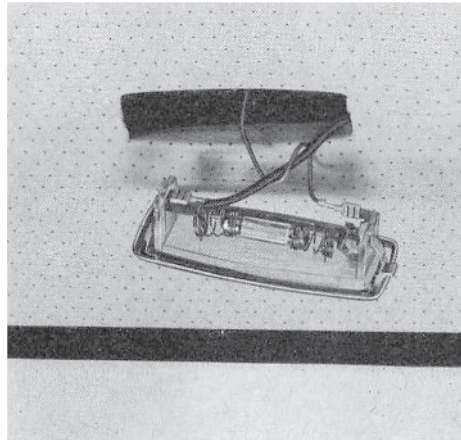

Install new bulb.
Insert housing at rear first, then press it in until retaining spring engages.

Engine compartment

Before working on any part of the engine compartment, turn off the engine and let it cool down sufficiently. If work has to be done with the engine running, exercise extreme caution to prevent neckties, jewelry or long hair from getting caught in the V-belt.

You have access to the engine compartment through the rear outside engine compartment lid and through another lid located inside the luggage compartment.

To open the lid inside the luggage compartment, roll the floor covering out of the way, then turn the lid handles to the OPEN position and lift up the lid.

To close the lid, perform the operation in reverse order.

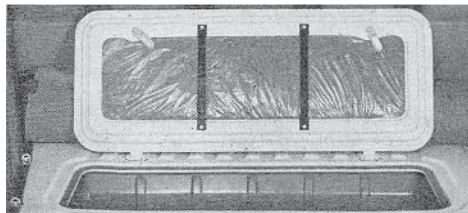

Spark plugs

The correct spark plug gap is 0.028 inch. Since the spark plug gap tends to increase in time during normal operation, it is advisable to replace spark plugs every 12,000 miles.

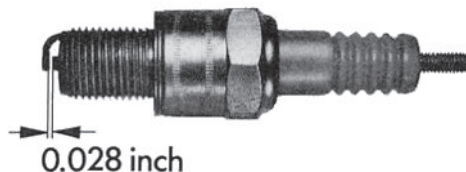

Removing spark plugs

For better access to the spark plugs, remove the air cleaner. See page 61 on how to remove and install the air cleaner.

Grasp the spark plug connector and pull it off. Do not pull the ignition wires as they may separate from the connectors.

Unscrew the spark plugs with a suitable spark plug wrench.

Cleaning spark plugs

Dirty spark plugs should be cleaned with a sand blaster, but if not available, the carbon can be removed with a wood or plastic pick. Do not use a wire brush. The plugs should also be clean and dry on the outside to avoid shorting and arcing. **The gap can be set by bending the outside electrode. The gap should be 0.028 inch.**

Installing spark plugs

Insert them by hand and screw them into the cylinder head as far as they will go. Only then use the spark plug wrench to tighten them firmly. Do not overtighten.

When installing the end pieces of the cleaner duct, be sure the rubber sleeves between cleaner and end pieces, and the rubber seal on the carburetors are located properly.

Reconnect all hoses. Interchanging of hoses affects the operation of the engine. Therefore, make sure the hoses are properly reconnected.

Checking the engine oil level

Your VW will usually not need additional oil between the scheduled changes.

Even so, you should check the oil level from time to time. To get a true reading, be certain the car is on level ground. Wait at least 5 minutes after the engine has been stopped; give the oil time to collect in the crankcase.

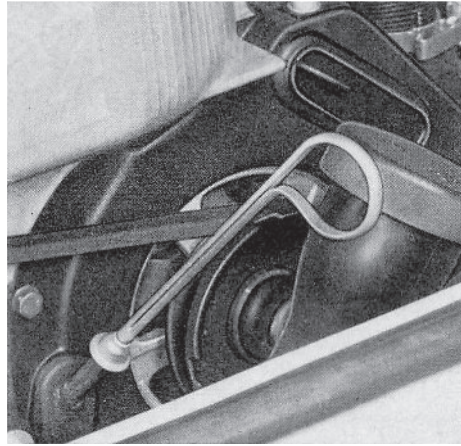

To check the oil level, take the dipstick out and wipe it clean first. Now, insert and pull it out again. You have enough oil in the engine if the oil level is between the upper and lower marks on the dipstick.

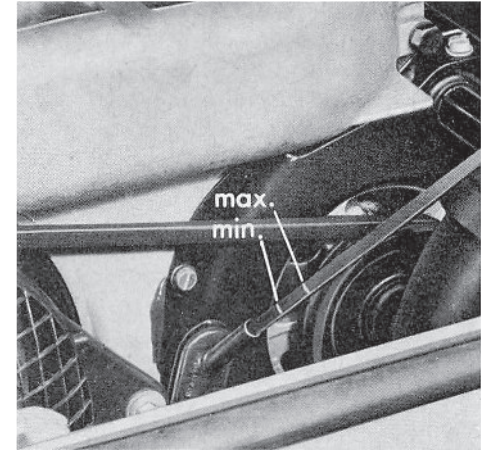

Only add the amount of oil that is needed. Always select a well-known brand and the recommended grade. Details about the correct oil viscosities are on page 63.

Changing the engine oil

Change the oil in your engine at least every 3,000 miles. This is very important as the lubricating properties of oil diminish gradually during normal operation of the car.

Drain the oil when the engine is still warm. Remove the drain plug — A — first. After the oil is drained, take out the oil strainer by removing the center nut — B — and clean it. The cleaning of the strainer should be done with every oil change. Use new gaskets and copper washers when re-installing the strainer to be sure no oil leaks will develop later.

Fill the engine with oil labeled “For Service SD” (“MS”). For the right oil viscosity, see page 63.

Engine oil capacity:

| | |
|-----------------------|--|
| With filter change | 3.5 liters 6.125 US pints 5.304 Imp. pints |
| Without filter change | 3.0 liters 5.25 US pints 4.55 Imp. pints |

The full flow oil filter should be replaced every 6,000 miles.

Important

The center nut for the oil strainer should be tightened with a torque wrench. The correct torque is 1.0—1.3 mkg (7-9 ft. lb.).

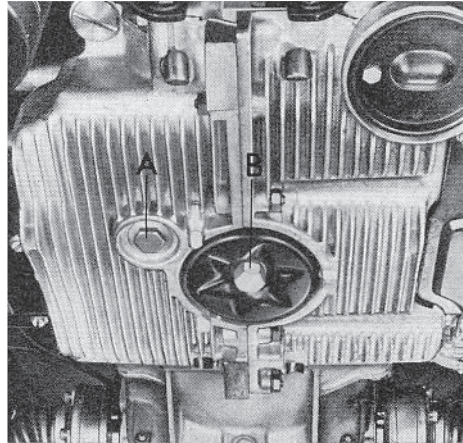

Because of detergent additives in the oil, the fresh oil will look dark after the engine has been running for a short time. This is to be expected, and there is no reason to change the oil at intervals shorter than 3,000 miles.

A special wrench should be used to screw the oil filter off and on.

We recommend more frequent oil changes (every 1,500 miles) if you drive your car only short distances during the winter

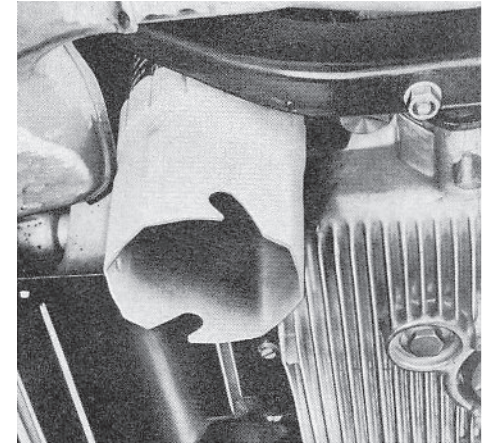

months. If you drive for only a few hundred miles a month under these conditions, we advise you change the oil every 6 to 8 weeks.

In arctic areas with temperatures generally below -13° F, change the oil every 750 miles.

Manual Transmission oil

Both transmission and final drive are combined in one housing. The lubricant used is hypoid oil that is changed by your dealer only one time at 600 miles as part of the lubrication service. See page 75.

The transmission is checked for leaks during the maintenance service. Should the need arise to replenish the oil filling, it should only be done with the necessary workshop equipment. Generally, hypoid oil is not marketed in small quantities.

Automatic Transmission Fluid

Checking the ATF level

The torque converter and the transmission are lubricated with Automatic Transmission Fluid (ATF). The final drive requires hypoid oil SAE 90 only.

The ATF has to be checked every 6,000 miles. A correct ATF level is very important for the proper functioning of the transmission. The reading should be done when the ATF is warm; with the engine idling, the selector lever in Neutral and the parking brake applied.

The ATF filler neck is in the engine compartment on the left hand side above

A = dipstick

B = filler neck

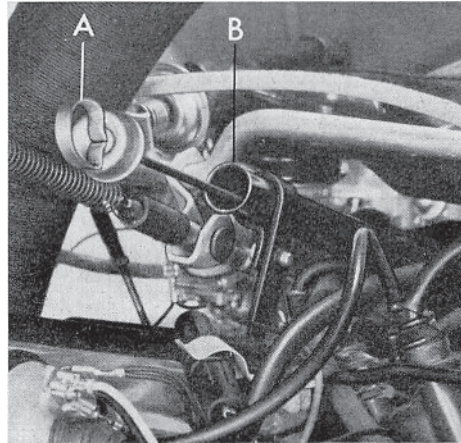

the ignition distributor. The dipstick is attached to the plug. Pull it out and wipe it clean. The ring-shaped handle should be in the vertical position when reinserting the dipstick to measure the fluid level.

Do not tow the car or run the engine when there is no ATF in the transmission.

You have enough ATF if the fluid level is between the two marks on the dipstick. It should never be above or below these marks. If necessary, add ATF, but only as much as is needed, and have the transmission checked for possible leaks. Keep in mind that the difference between the lower and upper mark is only 0.85 U. S. pint (0.74 Imp. pt.).

To add ATF, a clean funnel with a hose should be used. For correct ATF specifications, see page 64.

Changing the ATF

Every 30,000 miles the complete ATF filling has to be changed. The ATF filling should be changed every 18,000 miles under heavy duty conditions such as: continued stop-and-go traffic, extended mountain driving, and at extremely high outside temperatures.

The transmission oil in the final drive does not have to be changed.

Air cleaner

All the dust present in the air drawn in by the engine is retained by the filter element in the air cleaner.

A dirty air cleaner not only reduces the engine output but can also cause premature engine wear. If local conditions are such that the vehicle is often driven on

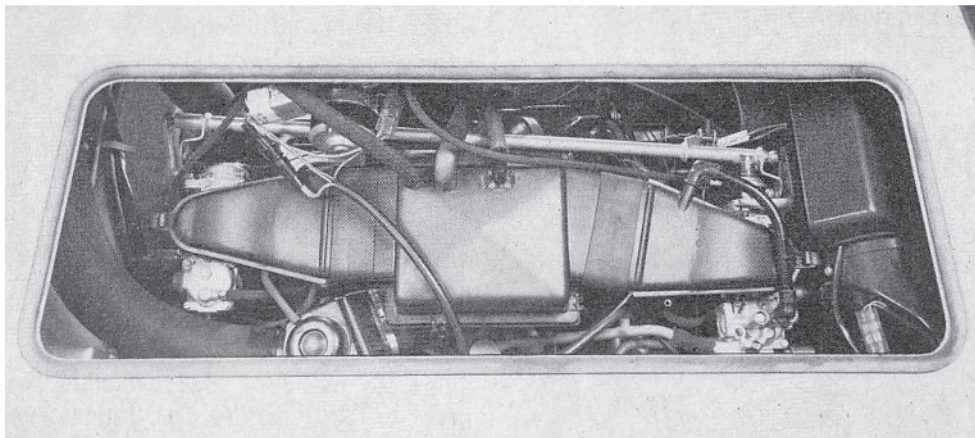

very dusty roads, the cleaner must be cleaned or replaced frequently.

Under normal conditions it is not necessary to replace the filter element more frequently than is mentioned in the Diagnosis and Maintenance Service Schedule.

Note

Under no circumstances may the paper element be cleaned or soaked with gasoline, cleaning solvents or oil.

To check or replace the filter element, the air cleaner must be removed. Do the following:

Take all the hoses off the air cleaner. Note the hose connections since interchanging of hoses affects the operation of the engine.

Release the two clamps which hold the air cleaner to the engine. Pull back the clips which hold the air cleaner duct end pieces on the carburetors. Take end

pieces off separately. Lift out air cleaner. Loosen the four clamps and take off the top part of the cleaner.

Take the filter element out and clean or replace it. Remove the dirt by shaking the filter element out with the dirt trapping side down.

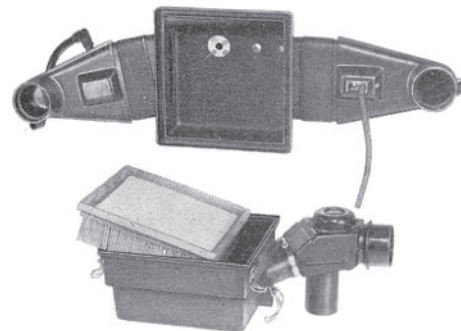

When installing the cleaner, check that the rubber seals on the carburetors and the rubber sleeves between cleaner upper part and end pieces fit properly. Reconnect all hoses.

Lubrication

Front axle

Lubricate the front axle once a year or every 18,000 miles.

Lift the front end of the car to take the weight off the front wheels. This is necessary to free the bearings to accept the lubricant. There are 5 grease fittings for the front axle. For their location, see arrows in the illustration.

Before forcing grease into the fittings, be sure to wipe them clean with a piece of cloth. Force lithium-based multi-purpose grease into the fitting until fresh grease starts to emerge at the sealing rings.

Wipe off any grease or oil that may have come in contact with tires or brake hoses because grease and oil have an adverse effect on rubber.

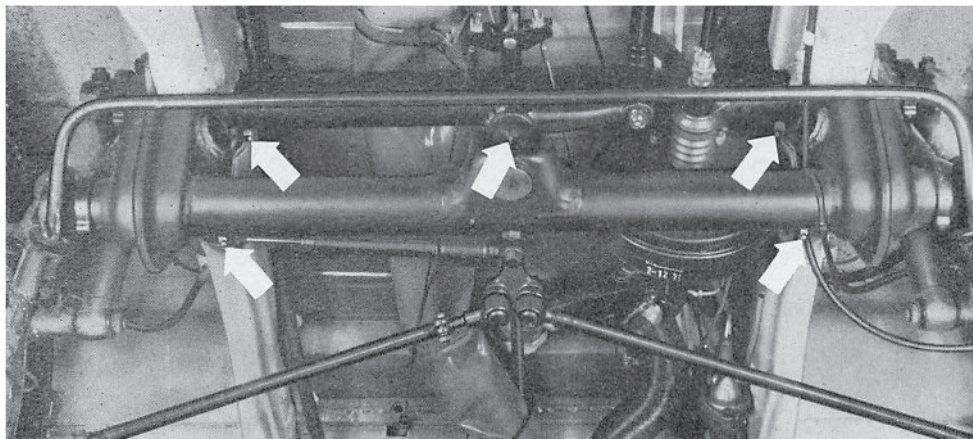

Door hinges and locks

Above the door hinge pin is a small oil chamber which is sealed with a plastic plug. At least every six months, the amount of oil in the chamber should be checked after lifting the plug with a screwdriver. The chamber should be filled with SAE 30 engine oil. Press plug in and wipe off excess oil with a cloth.



At the same time, the hinge for the sliding door (see arrows), and the rear door hinges should be oiled.

Lubricate the **door lock cylinders** with graphite. Dip the key into graphite and turn it in the lock a few times.

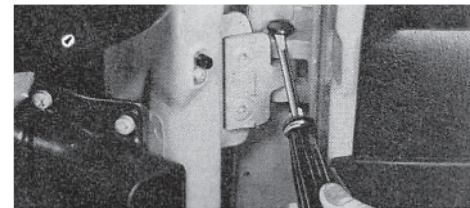

Engine oil

Always use a name brand oil labeled “For Service SD” (“MS”) for the engine of your Volkswagen.

Engine oils are graded according to their viscosity. The proper grade to be used in your engine depends on existing climatic or seasonal conditions.

The following table contains the grading for oils to be used in VW engines.

| | | | |
|------------------|-------------|---|-----------|
| Tropical climate | Hot season | | SAE 40 |
| | Cool season | | SAE 30 |
| Moderate climate | Summer | | |
| | Winter | At average outside temperature above 5° F | |
| | | At average outside temperatures not lower than —13° F | SAE 10 W* |

If outside temperatures are continuously below —13° F use SAE 5 W*

As temperature ranges of the different oil grades overlap, brief variations in outside temperatures are no cause for alarm. It is also permissible to mix oil of different viscosities if you find it necessary to add oil.

* Avoid high speed long distance driving when using SAE 10 W or SAE 5 W if outside temperatures rise above the indicated limits.

Temperature ranges of SAE grades

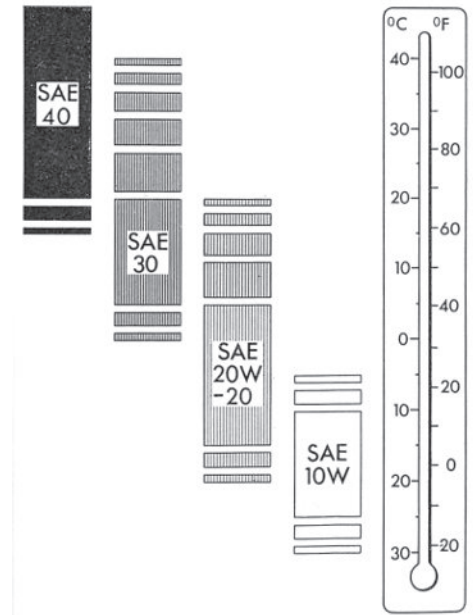

Transmission oil and Automatic Transmission Fluid (ATF)

A — Manual Transmission

Transmission and final drive are both lubricated with hypoid oil according to Mil—L—2105—B specifications (additive basis: sulfur-phosphorous):

SAE 90 In general all year.

SAE 80 In areas with cold climate.

ATF In areas with arctic climate and temperatures consistently below —13° F.

ATF is a special fluid for automatic transmissions, but ATF can also be used in the Manual Transmission under the above mentioned climatic conditions.

B - Automatic Transmission

The final drive has to be lubricates only with hypoid oil SAE 90.

Automatic Transmission and torque converter require ATF all year round.

All ATF's labeled "Dexron®" with a five-digit number preceded by the letter "B" can be used.

Lubricant additives

No additive should be mixed with fuel or lubricating oils and transmission fluids.

Grease

1. **Multi-purpose grease with lithium base** should be used for the front axle.
2. **Dry stick lubricant** should be used for the hood locks and the sliding surfaces of the striker plates.
3. **Silicone spray or petroleum jelly** should be used for the battery terminals and posts.

Troubleshooting

Your Volkswagen should repay you with trouble-free driving if it receives regular maintenance.

Should you ever encounter difficulty in starting your engine or have trouble on the road, there are a few simple repairs which you can make to get your VW going again. Locate the PROBLEM and PROBABLE CAUSE of the trouble in the guide on the following two pages and follow the directions on WHAT TO DO.

Caution

Exercise extreme caution when working on any part of the car to prevent accidental injury. Incomplete or improper servicing may also cause problems in the operation of the car. If in doubt about any servicing, have it done by a qualified mechanic or by your Authorized VW Dealer.

Note The adjustment of idling and ignition timing requires special equipment. We suggest that you consult your Authorized Volkswagen Dealer.

| Problem | Probable Cause | What To Do |
|---|--|---|
| VW will not start: engine will not turn over or turns over too slowly | <ol style="list-style-type: none"> 1. Run down or dead battery 2. Loose connection <ol style="list-style-type: none"> A. At battery B. At starter C. At connections behind dashboard 3. Starter defective 4. On vehicles with Automatic Transmission: The selector lever is not in starting position | <ol style="list-style-type: none"> 1. Charge or replace battery 2. Make sure that all connections are tight <ol style="list-style-type: none"> A. Check both cable connections on battery and grounded end of ground strap B. Check connections at solenoid (mounted on starter) under right rear of vehicle C. Check push-on connectors behind dashboard 3. Ask for assistance 4. Shift into Neutral or Park |
| VW will not start: engine turns over | <ol style="list-style-type: none"> 5. Loose connection in ignition system 6. Loose connection in primary circuit to coil 7. No spark at spark plugs | <ol style="list-style-type: none"> 5. Check for loose connections at coil, distributor and spark plugs 6. Check push-on connector at coil (thin black wire). Check tight fit of spark plug connectors. Check ignition wires for tight fit. 7. If sparks appear at high tension cable, the distributor cap should be cleaned inside and outside. Reconnect high tension cable. Remove all spark plugs. If plugs are clean and dry, reconnect ignition cables to spark plugs and bring spark plugs in connection with metal (ground). Hold cable with dry piece of cloth to avoid shock. Sparks should appear between spark plug electrodes when the engine is turned over. If not, clean and dry ignition cables and spark plug connectors and check that ignition cables are tight in distributor cap and plug connectors. Ask for assistance if the above steps did not ensure proper ignition Dirty or wet spark plugs should be cleaned and dried. Install new plugs if necessary. Unburned gasoline on plug electrodes points to excessive fuel supply |

| Problem | Probable Cause | What To Do |
|---|---|---|
| VW will not start: engine turns over | <p>8. If spark is fairly good at plugs, trouble is most likely in fuel system</p> <p>A. Caused by improper starting procedure. If the gas pedal is depressed too often, the carburetor accelerator pumps inject too much gasoline</p> <p>B. Carburetors may be flooded, float or needle valve may be sticking</p> | <p>8. Check fuel system in the following sequence:</p> <p>A. Depress gas pedal completely and operate starter for a prolonged period. If engine does not start, remove and dry spark plugs, turn over engine with plugs removed for approximately 30 seconds. Reinstall plugs and start engine</p> <p>B. Tap around outside of carburetor with wooden or plastic tool handle. Wait a few minutes and try starting again as described at 8 A</p> |
| Engine stalls shortly after starting | <p>9. Poor fuel supply</p> <p>10. Automatic chokes do not open, excessive fuel supply</p> | <p>9. See paragraph 12 and 13</p> <p>10. Check whether choke valves are in vertical position after ignition has been switched on for 2-5 minutes (depending on outside temperatures). Covers for choke units must be hot. If choke valves are binding in a closed position, open at fast idle cam and if necessary, retain with wire.</p> |
| Engine stalls while vehicle is driven | <p>11. Defect in ignition system</p> <p>12. Fuel supply is exhausted</p> <p>13. Gasoline may be contaminated by water, dust or dirt</p> | <p>11. See paragraphs 5 through 7</p> <p>12. Check whether any gasoline is left in tank</p> <p>13. See your VW dealer for cleaning of all components of the fuel system</p> |
| Red warning light for oil pressure comes on while you are driving | <p>14. If light goes on, the oil pressure is too low</p> | <p>14. Stop at once and check oil level. Add oil as necessary. If the oil level is sufficient and light goes on during driving, contact the nearest Authorized VW Dealer before driving on</p> |
| Red warning light for alternator comes on while you are driving | <p>15. If light goes on, V-belt may be torn or alternator does not charge</p> | <p>15. If belt drives alternator without slipping, switch off all unnecessary electrical equipment (radio, etc.). Drive to nearest VW dealer as otherwise the battery will soon run down</p> |

Owner Relations

There are more than 1150 authorized Volkswagen dealers in the 50 U. S. states. Their addresses and telephone numbers are compiled in a booklet which is available at your VW Dealer.

Any one of these dealers is well equipped to help you with virtually all VW-related matters; and your dealer should be your primary source.

Should there be an occasion where you need further assistance, you may want to contact your area distributor. We have listed their addresses and telephone numbers on the next page.

However, remember that ultimately your questions will be resolved in the dealership with the dealer personnel and dealer equipment. We therefore suggest you contact your dealer first.

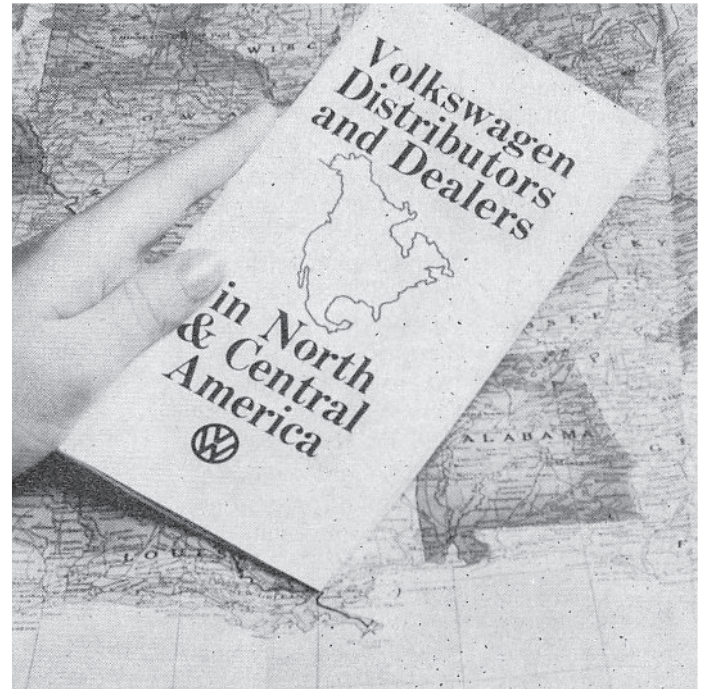

Addresses of VW Distributors in the US:

| | | | |
|-------------------------|--|---------------------------|-----------------------------------|
| Maine | Volkswagen Northeastern | Connecticut | World-Wide Volkswagen Corporation |
| Massachusetts | Distributor, Inc. | New York | Greenbush Road |
| New Hampshire | 100 Fordham Road | New Jersey | Orangeburg, New York 10962 |
| Rhode Island | Wilmington, Massachusetts 01887 | | (914) 359-5000 |
| Vermont | (617) 658-6700 | Washington, D.C. | Volkswagen South Atlantic |
| Illinois | Volkswagen North Central | Maryland | Distributor, Inc. |
| Iowa | Distributor, Inc. | North Carolina | 9300 George Palmer Highway |
| Minnesota | 3737 Lake Cook Road | Tennessee (East) | Lanham, Maryland 20801 |
| North Dakota | Deerfield, Illinois 60015 | Virginia | (301) 577-2600 |
| South Dakota | (312) 272-5500 | Arizona | Volkswagen Pacific, Inc. |
| Wisconsin | | California (South) | 11300 Playa Street |
| Kentucky | Midvo, Incorporated | Nevada (South) | Culver City, California 90230 |
| Ohio | 5000 Post Road | Hawaii | (213) 390-6226 |
| | Dublin, Ohio 43017 | | (213) 870-3381 |
| | (614) 889-2911 | Alaska | Riviera Motors, Inc. |
| Indiana | Import Motor Ltd., Inc. | Idaho | 10350 S. W. 5th, Street |
| Michigan | P.O. Box 2008 (2660 28th St., S.E.) | Montana | Beaverton, Oregon 97005 |
| | Grand Rapids, Michigan 49501 | Oregon | (503) 646-3111 |
| | (616) 949-7788 | Washington | |
| Florida | Volkswagen Southeastern | Arkansas | Volkswagen Mid-America Inc. |
| Georgia | Distributor, Inc. | Missouri | 8825 Page Boulevard |
| South Carolina | 155 East 21st Street | Kansas | St. Louis, Missouri 63114 |
| | Jacksonville, Florida 32203 | Nebraska | (314) 429-2141 |
| | (904) 355-1684 | Colorado | Volkswagen South Central |
| Delaware | Volkswagen Atlantic, Inc. | New Mexico | Distributor, Inc. |
| Pennsylvania | 1001 South Trooper Road | Oklahoma | P.O. Box 2207 |
| | Valley Forge, Pennsylvania 19481 | Texas | San Antonio, Texas 78298 |
| | (215) 666-7500 | Wyoming | (512) 341-8881 |
| Alabama | International Auto Sales & Service, Inc. | California (North) | Reynold C. Johnson Company |
| Louisiana | 4200 Michoud Boulevard | Nevada (North) | 7100 Johnson Industrial Drive |
| Mississippi | New Orleans, Louisiana 70129 | Utah | Pleasanton, California 94566 |
| Tennessee (West) | (504) 254-1500 | | (415) 828-6700 |

Technical Data

Engine

Four cylinder, four stroke, horizontally opposed in rear.
Air cooling by fan on crankshaft, thermostatically controlled.
Pressure oil feed with gear-type pump.
Oil cooler, full flow filter and strainer.
Mechanical fuel pump.
Two downdraft carburetors with automatic chokes and accelerator pumps. Air cleaner with load and temperature sensitive intake air pre-heating.
Exhaust emission control system. Activated charcoal filter in the fuel system.

| | | |
|----------------------------------|--|---|
| Bore | | 3.54 in. (90 mm) |
| Stroke | | 2.60 in. (66 mm) |
| Displacement | | 102.5 cu. in. (1679 cc) |
| Compression ratio | | 7.3:1 |
| Maximum output SAE net | Manual Transm. 63 hp at 4800 rpm Automatic Transm. 59 hp at 4200 rpm | |
| Maximum torque SAE net | Manual Transm. 81.0 lb.ft. at 3200 rpm Autom. Transm. 83.0 lb.ft. at 3200 rpm | |
| Valve clearance with engine cold | | 0.006 in. (0.15 mm) intake and exhaust |
| Fuel rating | | 91 Octane Regular incl. lead- free fuels |
| Oil consumption | U. S. — 1.7—4.8 pints per 1000 miles Imp. — 1.4—4.0 pints per 1000 miles Metric — 0.5—1.4 liters per 1000 km | |

Automatic Transmission

Automatic transmission combined with final drive. The transmission consists of a hydrodynamic torque converter and planetary gearing with three forward gears and one reverse. Drive shafts with two constant velocity joints per shaft.

Manual Transmission

Single plate dry clutch.
Clutch pedal, free play: $\frac{3}{8}$ — $\frac{3}{4}$ in. (10—20 mm)
Baulk synchronized four-speed gearbox and bevel gear differential in one housing.
Drive shafts with two constant velocity joints per shaft.

Chassis

Unitized body, frame plates reinforced with side and cross members front axle bolted to frame side members, engine/transmission suspended in 4 rubber-metal mountings. independent wheel suspension: torsion arms with ball joints at front, double jointed axles with trailing arms and diagonal links at rear. Torsion bar telescopic shock absorbers, stabilizer at front. Roller steering with maintenance- free tie rod and hydraulic steering damper. Hydraulic dual- circuit power assisted foot brakes with pressure regulator for rear wheel circuit. Front wheels with disc brakes, rear wheels with drum brakes.
Mechanical parking brake effective on rear wheels.

| | | |
|---|-----------|---|
| Wheelbase | | 91.5 in (2400 mm) |
| Turning circle diameter | | approx. 40 ft. (12.3 m) |
| Track at front* | | 54.8 in. (1395 mm) |
| Wheel-toe angle (wheels pressed together) | | 0.024 ± 0.071 in. (0.6 ± 1.8 mm) |
| Camber | | 0° 40' ± 20' |
| Track at rear* | | 57.2 in. (1455 mm) |
| Wheels | | 5½jx14 (Perforated discs with drop center rims) |

Tire size and pressure see sticker behind driver's seat

* at gross vehicle weight

Electrical System

| | |
|-----------------------------|--|
| Voltage | 12 Volts |
| Battery | 45 Ah |
| Starter | 0.7 hp |
| Alternator with regulator | max. 55 A |
| V-belt size | 9.0 x 965 |
| Ignition distributor . . . | with combined vacuum and centrifugal spark advance and speed limiter |
| Firing order | 1—4—3—2 |
| Basic ignition timing . . . | 63 hp engine 5° after TDC* 59 hp engine 10° after TDC* |
| Contact breaker gap . . . | 0.016 in. (0.4 mm) |
| Spark plug | Bosch W 145 T2 } or plugs with similar Beru 145/14/3 } values from other } manufacturers |
| Plug thread | 14 mm |
| Electrode gap | 0.028 in. (0.7 mm) |

Capacities

| | |
|--|---|
| Fuel tank | 15.8 US gallons (13.2 Imp. gallons) |
| Engine oil with filter change | 7.4 US pints (6.1 Imp. pints) |
| Engine oil without filter change | 6.3 US pints (5.3 Imp. pints) |
| Transmission and final drive | 7.4 US pints (6.1 Imp. pints) |
| On vehicles with Automatic Transmission: | |
| Torque converter and planetary gears | approx. 12.7 US pints (10.6 Imp. pints) |
| refill with | 6.3 US pints (5.3 Imp. pints) |
| Final drive | approx 2.0 US pints (1.8 Imp. pints) |
| Brake system | 1.01 US pints (0.84 Imp.pints) |
| Windshield washer . . . | 2.9 US pints (2.4 Imp. pints) |

* engine at operating temperature, at 850 rpm, white mark on fan.
Set only with stroboscope timing light and vacuum hoses attached.

Dimensions and weights

| | Station Wagon | Kombi | Camp-mobile | Delivery Van |
|--|---------------|--------|-------------|--------------|
| Length in. | 179.0 | 177.4 | 177.4 | 177.4 |
| Width in. | 69.3 | 67.7 | 67.7 | 67.7 |
| Height, unladen . . . in. | 76.4 | 76.8 | 80.0 | 77.0 |
| Ground clearance . . in. | 7.3 | 7.3 | 7.3 | 7.3 |
| Unladen weight . . . lbs. | 3043 | 2922 | 3296 | 2745 |
| Vehicle capacity weight lbs. | 1918 | 2150 | 1665 | 2327 |
| Gross vehicle weight lbs. | 4961 | 5072 | 4961 | 5072 |
| Gross axle weight . . lbs. | | | | |
| front lbs. | 2227 | 2227 | 2227 | 2227 |
| rear lbs. | 2800 | 2867 | 2800 | 2867 |
| Permissible roof and trailer weights: | | | | |
| Roof weights . . . lbs. | 220* | 220* | 220 | 220* |
| Trailer without brakes lbs. | 1100 | 1100 | 1100 | 1100 |
| Trailer tongue load . lbs. | 55-110 | 55-110 | 55-110 | 55-110 |

* Applies only to roof rack mounted to rain gutters. Distribute load evenly.

Performance

| | |
|----------------------------------|--------|
| Maximum and cruising speed | |
| Manual Transmission | 78 mph |
| Automatic Transmission | 74 mph |

In any authorized VW dealer's service department, you get VW Specialists who know VW's intimately.

A VW Specialist works on VW's. Period.

Every so often he takes time off and gets a refresher course at one of our VW training centers.

So he learns to fix Volkswagens before he starts working on your car. Rather than while he is working on your car.

We think it is better that way.

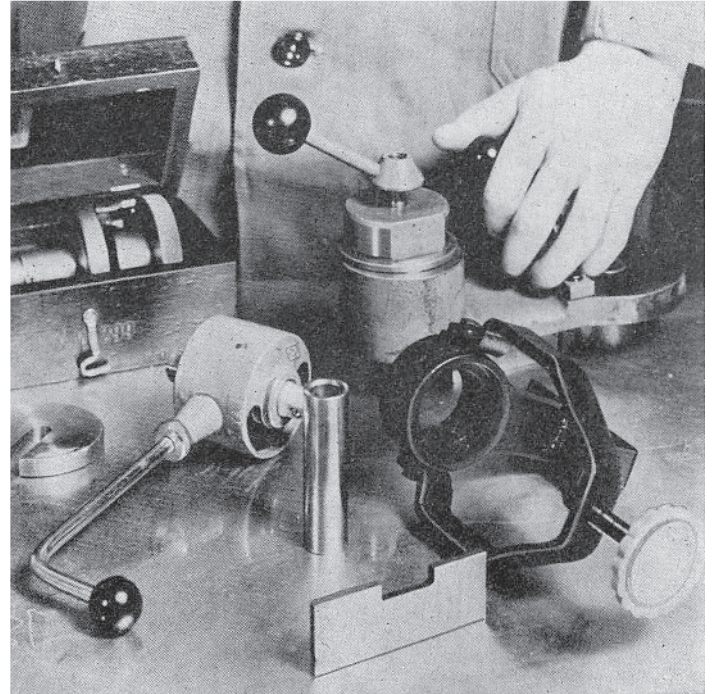

**Authorized VW Dealers use a unique service system
specially developed for the VW**

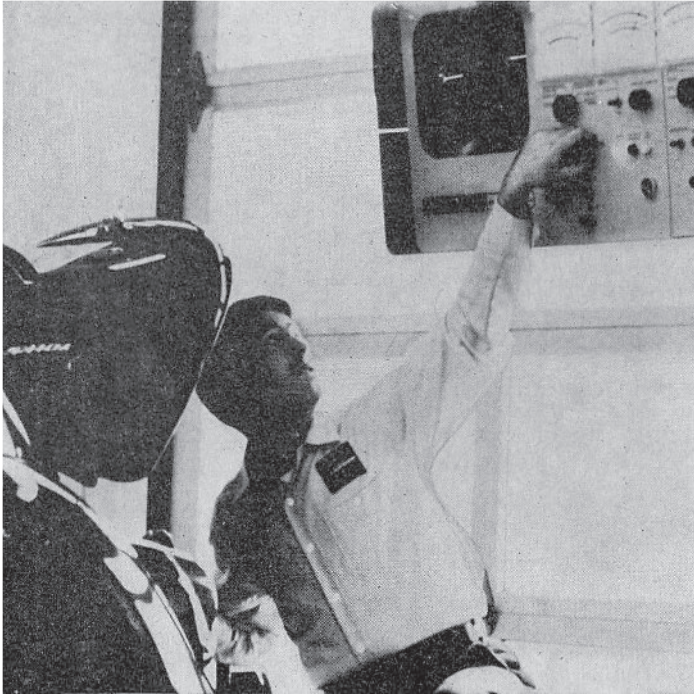

Lots of service stations say they can repair Volkswagens and a lot of them really can.

But they cannot offer you VW Diagnosis. Instead of giving every VW the same basic maintenance, we treat each one as an individual. And we have already prepared your car for an even more advanced diagnosis system.

The socket in the engine compartment is a part of this system.

Today specially trained diagnosticians will check your VW directly using special testing equipment and that means your car gets just the maintenance it needs. No more, no less.

And you get a test report so you know the exact condition of your VW.

It tells you a lot about the car you drive.

VW Diagnosis and Maintenance

The **VW Diagnosis and Maintenance Service** has been developed to give each car “tailored maintenance”. In other words, just the proper amount of service that each individual car needs.

The **Diagnosis and Maintenance Record**, which appears at the end of this manual, shows you the mileage intervals at which diagnosis and maintenance services should be performed to keep your car in top driving condition.

Every Authorized Volkswagen Dealer at home or abroad will perform all the operations listed for VW Diagnosis, VW Maintenance, and the additional services (such as oil changes, lubrication, brake fluid renewal) in accordance with Volkswagen quality service standards.

The **first maintenance service at 600 miles is free of charge**; you only pay for the engine and transmission oil change. From then on, every 6,000 miles your car will be tested through VW’s unique diagnosis service system. You are entitled to **free diagnosis services at 6,000, 12,000, 18,000 and 24,000 miles**.

The VW Diagnosis Test Report will show precisely what work might be necessary in addition to the regular maintenance and oil change services that your VW requires.

If your Volkswagen is driven less than 18,000 miles in twelve months, have the front end lubricated once a year.

Of course, you can obtain a VW Diagnosis at any time — outside the regular schedule — at your Authorized VW Dealer. Especially if you drive less than 6,000 miles a year, we recommend you have a VW Diagnosis performed at least once a year.

Your Authorized Volkswagen Dealer will certify on the mileage chart at the end of this manual which services have been completed.

If you have your car serviced somewhere other than at an Authorized VW Dealer, retain all receipts so that you can verify that regular services were performed at the recommended time or mileage intervals.

Oil Change and Maintenance Service 600 Miles

The free maintenance service at 600 miles consists of the following: (Lubricants, fluids and materials such as gaskets are paid by the customer).

Oil Change

- 1 - Engine: Change oil, clean oil strainer. Replace oil filter.
- 2 - Manual Transmissions: Change oil, clean magnetic drain plugs.

7 - Brake system: Check for damage and leaks. Check brake fluid level, add if necessary. Adjust foot and parking brakes.

8 - Electrical system: Check operation of all components, adjust headlights if necessary.

Maintenance Service

- 1 - V-Belt: Check, adjust if necessary.
- 2 - Valves: Check and adjust clearance.
- 3 - Clutch pedal free play: Check and adjust.
- 4 - Rear axle: Check torque of bolts on constant velocity joints.
- 5 - Front axle: Check tie rod ends and tie rods.
- 6 - Tires and wheels: Check tire pressure, including spare wheel.

During road test:

Check efficiency of braking, steering, heating and ventilation systems. Check overall performance.

After road test:

- 1 - Check and adjust idle speed.
- 2 - Check cylinder head covers for leaks.

VW Diagnosis and Maintenance

Oil Change Service

The engine in the Volkswagen requires little oil. But for long engine life, this oil should be changed every 3,000 miles. An oil change at a VW dealer includes the services shown below:

- 1 - Engine: Change oil, clean oil strainer.
- 2 - Battery: Check, add distilled water if necessary.
- 3 - Windshield washer: Check fluid.

VW Diagnosis

A physical checkup of your VW is extremely important for determining the amount of additional maintenance your vehicle may need for continuing peak performance.

Listed on the following pages is the VW Diagnosis procedure which applies to your vehicle.

Chances are, if you regularly maintained your vehicle, it is in good running condition.

The VW Diagnosis Test Report will be given to you so you will know the exact condition of your VW.

It is something you should know.

A VW Diagnosis every 6,000 miles consists of:

(only applicable operations on your vehicle will be performed)

Engine and Clutch:

- 1 - V-Belt: Check tension and condition.
- 2 - V-Belt for air pump: Check tension and condition.
- 3 - Ignition system: Check with electronic equipment.
- 4 - Compression: Check.
- 5 - Exhaust system: Check for damage.
- 6 - Manual Transmission.
Clutch: Check pedal free play.
- 7 - Engine: Check oil level.

Rear axle and transmission:

- 8 - Drive shafts: Check boots for leaks.

Front axle and steering:

- 9 - Front axle: Check dust seals and proper fit of plugs on ball joints, check dust seals on tie rod ends, check tie rods.
- 10 - Ball joints: Check play.
- 11 - Steering: Check play.
- 12 - Steering gear: Check for leaks.
- 13 - Front wheels: Check camber and toe.

Brakes, wheels, tires:

- 14 - Brake system: Check for damage and leaks.
- 15 - Brake pedal: Check free play.
- 16 - Brake pedal: Check pedal travel.
- 17 - Parking brake: Check adjustment.
- 18 - Brake fluid: Check level.
- 19 - Brake linings or pads: Check thickness.
- 20 - Tires, including spare wheel: Check for wear and damage, check and correct pressure.

Electrical system:

- 21 - Cranking system: Check with electronic equipment.
- 22 - Charging system: Check with electronic equipment.
- 23 - Kickdown switch and solenoid: Check.
- 24 - Check operation of headlights, high beam indicator light, parking lights, side marker lights, license plate light, emergency flasher, stop lights, tail lights, back-up lights, turn signals, horn, rear window defogger and brake warning light.
- 25 - Headlights: Check adjustment.
- 26 - Windshield wiper: Check operation.
- 27 - Windshield washer: Check operation and fluid.
- 28 - Battery: Check electrolyte level, check voltage under load.

Test Drive

Test drive if Diagnosis is not followed by maintenance or repair. If maintenance or repair follows the diagnosis, test drive after the job is completed.

- 1 - Check braking, clutch, kickdown, steering, heating, ventilation system (including fresh airfan) and overall performance.
- 2 - Check interior lights and instrument lights.
- 3 - Check ignition/steering lock and buzzer alarm.
- 4 - Check warning lights for alternator and oil pressure.
- 5 - Check safety belt warning light and buzzer alarm.
- 6 - Check operation of automatic transmission.
- 7 - Automatic Transmission: Check ATF level.

VW Maintenance

After your vehicle receives a VW Diagnosis, your Authorized Volkswagen Dealer can perform the VW Maintenance.

The maintenance which should be performed at specified mileage intervals is shown below.

There may be additional maintenance required which will show up on the VW Diagnosis Test Report.

Your VW Service Manager or Service Adviser will explain the results of the VW Diagnosis in detail.

This will help keep a small maintenance problem from growing into a big maintenance problem.

So that your VW will keep running like a VW.

A VW Maintenance every 6,000 miles consists of:

- 1 - Engine: Change oil, clean oil strainer. Replace oil filter.
- 2 - Valves: Check and adjust clearance.
- 3 - Door hinges and door checks: Lubricate.
Sliding door mounting points: Lubricate.
- 4 - Transmission: Check oil level, add if necessary.
- 5 - Automatic Transmission
Final drive: Check oil level, add if necessary.
Fluid pan: Check torque of bolts.
- 6 - Test drive: Check braking, clutch, kickdown, steering, heating, ventilation system and overall performance.
Cylinder head covers: Check for leaks.

In addition:

Every 12,000 miles

- 1 - Contact breaker points: Replace.
Adjust dwell angle. Check timing, adjust if necessary.
- 2 - Spark plugs: Replace.

Every 18,000 miles

- 1 - Front end: Lubricate.
- 2 - Air cleaner: Replace filter element (at least every 2 years).
- 3 - Air pump, air cleaner: Replace element (at least every 2 years).

Every 24,000 miles

- 1 - Automatic Transmission
Exhaust recirculation valve: Check, replace if necessary.
- 2 - Automatic Transmission
Filter element for exhaust recirculation: Replace (at least every 2 years).

Every 30,000 miles

- 1 - Automatic Transmission
Change ATF (includes removing and installing oil pan).

Important:

Change ATF every 18,000 miles if vehicle is operated under heavy duty conditions such as trailer towing, high outside temperatures, continuous mountain driving or constant stop and go traffic. If in doubt, consult your Authorized Volkswagen dealer.

Every 2 years

- 1 - Brakes: Replace brake fluid.
- 2 - Brake warning light switch: Check functioning.

| | | | | | | |
|--|---|---|--|--|---|--|
| <p>Delivery Inspection</p> <p>(Dealer Stamp)</p> <p>Date _____</p> <p>Miles _____</p> | <p align="center">600 miles</p> <p>Engine and Transmission Oil Change</p> <p>(Dealer Stamp)</p> <p>Date _____</p> <p>Miles _____</p> <p>Free Maintenance Services</p> <p>Valid only between 500 and 1,000 miles</p> <p>(Dealer Stamp)</p> <p>Date _____</p> <p>Miles _____</p> | | | | | |
| <p>3,000 miles Oil Change Service</p> <p>(Dealer Stamp)</p> <p>Date _____</p> <p>Miles _____</p> | <p>6,000 miles Free Diagnosis</p> <p>Valid only between 5,000 and 8,000 miles</p> <p>(Dealer Stamp)</p> <p>Date _____</p> <p>Miles _____</p> | <p>6,000 miles Maintenance</p> <p>(Dealer Stamp)</p> <p>Date _____</p> <p>Miles _____</p> | <p>9,000 miles Oil Change Service</p> <p>(Dealer Stamp)</p> <p>Date _____</p> <p>Miles _____</p> | <p>12,000 miles Free Diagnosis</p> <p>Valid only between 11,000 and 14,000 miles</p> <p>(Dealer Stamp)</p> <p>Date _____</p> <p>Miles _____</p> | <p>12,000 miles Maintenance</p> <p>(Dealer Stamp)</p> <p>Date _____</p> <p>Miles _____</p> | |
| <p>15,000 miles Oil Change Service</p> <p>(Dealer Stamp)</p> <p>Date _____</p> <p>Miles _____</p> | <p>18,000 miles Free Diagnosis</p> <p>Valid only between 17,000 and 20,000 miles</p> <p>(Dealer Stamp)</p> <p>Date _____</p> <p>Miles _____</p> | <p>18,000 miles Maintenance</p> <p>(Dealer Stamp)</p> <p>Date _____</p> <p>Miles _____</p> | <p>21,000 miles Oil Change Service</p> <p>(Dealer Stamp)</p> <p>Date _____</p> <p>Miles _____</p> | <p>24,000 miles Free Diagnosis</p> <p>Valid only between 23,000 and 26,000 miles</p> <p>(Dealer Stamp)</p> <p>Date _____</p> <p>Miles _____</p> | <p>24,000 miles Maintenance</p> <p>(Dealer Stamp)</p> <p>Date _____</p> <p>Miles _____</p> | |

| | | | | | |
|--|---|---|--|---|---|
| <p>27,000 miles Oil Change Service</p> <p>(Dealer Stamp)</p> <p>Date _____ Miles _____</p> | <p>Diagnosis 30,000 miles</p> <p>(Dealer Stamp)</p> <p>Date _____ Miles _____</p> | <p>30,000 miles Maintenance</p> <p>(Dealer Stamp)</p> <p>Date _____ Miles _____</p> | <p>33,000 miles Oil Change Service</p> <p>(Dealer Stamp)</p> <p>Date _____ Miles _____</p> | <p>36,000 miles Diagnosis</p> <p>(Dealer Stamp)</p> <p>Date _____ Miles _____</p> | <p>36,000 miles Maintenance</p> <p>(Dealer Stamp)</p> <p>Date _____ Miles _____</p> |
| <p>39,000 miles Oil Change Service</p> <p>(Dealer Stamp)</p> <p>Date _____ Miles _____</p> | <p>42,000 miles Diagnosis</p> <p>(Dealer Stamp)</p> <p>Date _____ Miles _____</p> | <p>42,000 miles Maintenance</p> <p>(Dealer Stamp)</p> <p>Date _____ Miles _____</p> | <p>45,000 miles Oil Change Service</p> <p>(Dealer Stamp)</p> <p>Date _____ Miles _____</p> | <p>48,000 miles Diagnosis</p> <p>(Dealer Stamp)</p> <p>Date _____ Miles _____</p> | <p>48,000 miles Maintenance</p> <p>(Dealer Stamp)</p> <p>Date _____ Miles _____</p> |
| <p>51,000 miles Oil Change Service</p> <p>(Dealer Stamp)</p> <p>Date _____ Miles _____</p> | <p>54,000 miles Diagnosis</p> <p>(Dealer Stamp)</p> <p>Date _____ Miles _____</p> | <p>57,000 miles Maintenance</p> <p>(Dealer Stamp)</p> <p>Date _____ Miles _____</p> | <p>60,000 miles Oil Change Service</p> <p>(Dealer Stamp)</p> <p>Date _____ Miles _____</p> | <p>60,000 miles Diagnosis</p> <p>(Dealer Stamp)</p> <p>Date _____ Miles _____</p> | <p>60,000 miles Maintenance</p> <p>(Dealer Stamp)</p> <p>Date _____ Miles _____</p> |

| | | | | | |
|--|---|---|--|---|---|
| <p>63,000 miles Oil Change Service</p> <p>(Dealer Stamp)</p> <p>Date _____ Miles _____</p> | <p>66,000 miles Diagnosis</p> <p>(Dealer Stamp)</p> <p>Date _____ Miles _____</p> | <p>66,000 miles Maintenance</p> <p>(Dealer Stamp)</p> <p>Date _____ Miles _____</p> | <p>69,000 miles Oil Change Service</p> <p>(Dealer Stamp)</p> <p>Date _____ Miles _____</p> | <p>72,000 miles Diagnosis</p> <p>(Dealer Stamp)</p> <p>Date _____ Miles _____</p> | <p>72,000 miles Maintenance</p> <p>(Dealer Stamp)</p> <p>Date _____ Miles _____</p> |
| <p>75,000 miles Oil Change Service</p> <p>(Dealer Stamp)</p> <p>Date _____ Miles _____</p> | <p>78,000 miles Diagnosis</p> <p>(Dealer Stamp)</p> <p>Date _____ Miles _____</p> | <p>78,000 miles Maintenance</p> <p>(Dealer Stamp)</p> <p>Date _____ Miles _____</p> | <p>81,000 miles Oil Change Service</p> <p>(Dealer Stamp)</p> <p>Date _____ Miles _____</p> | <p>84,000 miles Diagnosis</p> <p>(Dealer Stamp)</p> <p>Date _____ Miles _____</p> | <p>84,000 miles Maintenance</p> <p>(Dealer Stamp)</p> <p>Date _____ Miles _____</p> |
| <p>87,000 miles Oil Change Service</p> <p>(Dealer Stamp)</p> <p>Date _____ Miles _____</p> | <p>90,000 miles Diagnosis</p> <p>(Dealer Stamp)</p> <p>Date _____ Miles _____</p> | <p>90,000 miles Maintenance</p> <p>(Dealer Stamp)</p> <p>Date _____ Miles _____</p> | <p>93,000 miles Oil Change Service</p> <p>(Dealer Stamp)</p> <p>Date _____ Miles _____</p> | <p>96,000 miles Diagnosis</p> <p>(Dealer Stamp)</p> <p>Date _____ Miles _____</p> | <p>96,000 miles Maintenance</p> <p>(Dealer Stamp)</p> <p>Date _____ Miles _____</p> |

| | | |
|---------------------------|----------------------|----------------------|
| 99,000 miles | 100,000 miles | 100,000 miles |
| Oil Change Service | Diagnosis | Maintenance |
| (Dealer Stamp) | (Dealer Stamp) | (Dealer Stamp) |
| Date _____ | Date _____ | Date _____ |
| Miles _____ | Miles _____ | Miles _____ |

Additional Services Record

ATF (Automatic Transmission Fluid) changes apply to vehicles equipped with automatic transmission.

Important:

Change ATF every 18,000 miles if the vehicle is operated under heavy duty conditions such as trailer towing, high outside temperatures, continuous mountain driving or constant stop and go traffic. If in doubt, consult your Authorized Volkswagen Dealer.

The boxes to the right indicate a brake service that is required in addition to the preceding Maintenance schedule.

Your Authorized Volkswagen Dealer will perform this service at the recommended intervals.

It is the best way to keep your VW running. And running. And running.

| | | |
|---------------------|---------------------|---------------------|
| 30,000 miles | 60,000 miles | 90,000 miles |
| ATF Change | ATF Change | ATF Change |
| (Dealer Stamp) | (Dealer Stamp) | (Dealer Stamp) |
| Date _____ | Date _____ | Date _____ |
| Miles _____ | Miles _____ | Miles _____ |

| Brake Fluid Renewal and checking of brake warning light switch | | |
|--|-----------------------------------|-----------------------------------|
| after 2 years of operation | after 4 years of operation | after 6 years of operation |
| (Dealer Stamp) | (Dealer Stamp) | (Dealer Stamp) |
| Date _____ | Date _____ | Date _____ |
| Miles _____ | Miles _____ | Miles _____ |

The “National Traffic & Motor Vehicle Safety Act of 1966” requires manufacturers to be in a position to contact vehicle owners if a correction of a product defect becomes necessary.

Please fill in on of the attached postcards if you change your address or purchase a Used Volkswagen.

You need not use this card if you purchased your car through an Authorized Volkswagen Dealer.

Please quote the VW chassis number as it appears on the identification plate of the vehicle. Its location is shown on page 15. Do not use the abbreviated serial number as shown on the vehicle registration.

Additional cards can be obtained from any Authorized Volkswagen Dealer.

NOTICE OF ADDRESS CHANGE

NOTICE OF USED CAR PURCHASE

please check one of the above boxes

VW Chassis Number

Mo.

Day

Yr.

Last Name

First Name

Initial

Number

Street

City

State

Zip Code

Please print and give complete information.

New Vehicle Delivery Inspection

Checklist for _____
(Chassis number)

A. Install following items

- Windshield wiper blades
- Hub caps
- Outside mirror

B. Preparatory Services

- Battery electrolyte level, check
- Engine starting, check

C. Operation and safety items

- Door lock functioning, check
- Seat operation and adjustments, check
- Safety belts, locking mechanisms, retractors, warning light and buzzer alarm, check
- Ignition lock and buzzer alarm, check

Check operation of:

- Headlights, dimmer switch, parking lights, stop lights, turn signals, tail lights, side marker lights, license plate light, back-up lights, horn, windshield wiper and washer, rear window defogger, emergency flasher and brake warning light

Headlights, check adjustment

Wheel nuts, check torque

Cotter pins for rear exhaust, visually check for correct installation

Tire pressure (including spare wheel), check
Brake fluid level, check
Engine oil level, check
V-belt tension, check
Engine and transmission, visually check for leaks
Brake system, all brake lines and hoses, visually
check for leaks
Steering component lock plates and cotter pins,
visually check for proper setting

D. Road test

Foot and parking brake, check operation
Clutch and gear shifting, check operation
Ventilation and fresh air fan, check
Speedometer, check operation
Kickdown switch, check operation (where applicable)
Check operation of the following:
alternator and oil pressure warning lights,
high beam indicator, interior light,
instrument lights.

E. After road test

ATF level, check
Engine idle speed, adjust

Remarks: _____

Vehicle in perfect condition: _____

(Signature of Service Adviser) (Date)

BUSINESS REPLY MAIL
No Postage Stamp Necessary if Mailed in the United States

POSTAGE WILL BE PAID BY

VOLKSWAGEN of AMERICA, Inc.

818 Sylvan Avenue
Englewood Cliffs, N.J. 07632

FIRST CLASS
Permit No. 785
Englewood, N.J.
07631



NOTICE OF ADDRESS CHANGE

NOTICE OF USED CAR PURCHASE

please check one of the above boxes

VW Chassis Number

Mo.

Day

Yr.

Last Name

First Name

Initial

Number

Street

City

State

Zip Code

Please print and give complete information.

NOTICE OF ADDRESS CHANGE

NOTICE OF USED CAR PURCHASE

please check one of the above boxes

VW Chassis Number

Mo.

Day

Yr.

Last Name

First Name

Initial

Number

Street

City

State

Zip Code

Please print and give complete information.

FIRST CLASS
Permit No. 785
Englewood, N.J.
07631

BUSINESS REPLY MAIL

No Postage Stamp Necessary if Mailed in the United States

POSTAGE WILL BE PAID BY

VOLKSWAGEN of AMERICA, Inc.

818 Sylvan Avenue

Englewood Cliffs, N.J. 07632



FIRST CLASS
Permit No. 785
Englewood, N.J.
07631

BUSINESS REPLY MAIL

No Postage Stamp Necessary if Mailed in the United States

POSTAGE WILL BE PAID BY

VOLKSWAGEN of AMERICA, Inc.

818 Sylvan Avenue

Englewood Cliffs, N.J. 07632





Customer Identification Card

This is another feature of Volkswagen Service that adds to your convenience. Just present this booklet whenever you stop for service at your Authorized Volkswagen Dealer. Your Identification Card will quickly furnish the Service Adviser with your name and address and all pertinent vehicle data.

USA Typ 2